

CTM-1

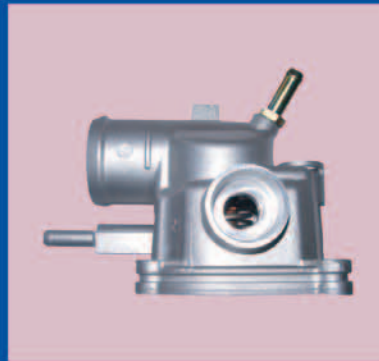

ANGLI



THERMOSTATS

THERMOSTATS / THERMOSTATE

LISTE D'APPLICATIONS

P.5

APPLICATION LIST

ANWENDUNGSLISTE

LISTE NUMÉRIQUE AVEC PHOTOS

P.153

NUMERICAL LIST WITH PICTURES

AUFLISTUNG MIT ZEICHUNGEN



CABLES DE RALENTIS

FAST IDDLLE

LISTE NUMÉRIQUE AVEC PHOTOS

P.199

NUMERICAL LIST WITH PICTURES

AUFLISTUNG MIT ZEICHUNGEN



CORRESPONDANCES

CROSS REFERENCES / CROSS LIST

P.203

Les constructeurs de véhicules se réservant le droit de modifier sans préavis les dénominations et caractéristiques de leurs productions, les renseignements contenus dans le présent catalogue ne sont donnés que sous réserve, et ne sauraient en aucun cas engager notre responsabilité.

Toute reproduction, même partielle, du présent catalogue, sans l'autorisation de la Société Vernet, est interdite.

Edition Septembre 2006.



THERMOSTATS

THERMOSTATS / THERMOSTATE

LISTE D'APPLICATIONS

P.5

*APPLICATION LIST**ANWENDUNGSLISTE*

LISTE NUMÉRIQUE AVEC PHOTOS

P.153

*NUMERICAL LIST WITH PICTURES**AUFLISTUNG MIT ZEICHUNGEN*

LISTE DES CORRESPONDANCES

P.203

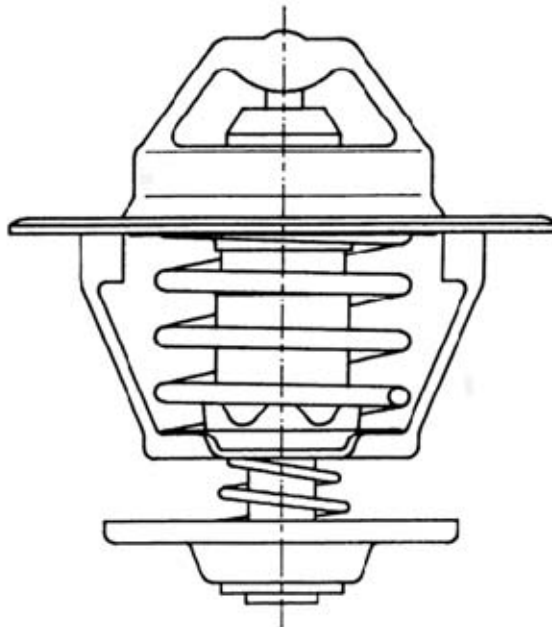



*CROSS REFERENCES**CROSS LIST*



VEHICULE MODEL FAHRZEUGTYP	MOTEUR ENGINE MOTOR	CYLINDRÉE ENGINE SIZE HUBRAUM	ANNÉE YEAR JAHR	VERNET	PHOTOS PICTURES ZEICHUNGEN
----------------------------------	---------------------------	-------------------------------------	-----------------------	--------	----------------------------------

ALFA ROMEO

Alfa 33

1.2	AR30500	1189	08/83>07/89	1508.83		
	AR30500	1189	08/83>07/89	5953.86		
	AR30585	1189	08/83>07/89	1508.83	1508	5953
	AR30743	1186	08/89>09/94	5953.86		
1.3 AS	AR30512	1351	08/83>07/86	1508.83		
	AR30512	1351	08/84>07/86	5953.86		
	AS30568	1351	08/84>07/86	1508.83		
	AS30568	1351	08/84>07/86	5953.86		
1.3 AS Sport Wagon	AS30168	1351	09/86>07/89	1508.83	5964	6463
	AS30587	1351	07/88>07/89	1508.83		
1.3 DC	AR30168	1351	09/86>07/89	1508.83		
	AR30168	1351	07/88>07/89	5953.86		
	AR30502	1351	08/83>07/89	1508.83		
	AR30502	1351	08/83>07/89	5953.86		
	AR30586	1351	09/86>07/89	1508.83		
1.3 Sport Wagon	AR30732	1351	08/89>09/94	5953.86		
	AS30168 / -587	1351	07/88>07/89	5953.86		
1.4 Sport Wagon	AR30755 / -753	1351	08/89>09/94	5953.86		
1.5	AR30146	1490	09/86>07/89	5953.86		
	AR30182	1490	08/84>07/86	5953.86		
	AR30526 / -520	1490	09/86>07/89	5953.86		
	AR30734	1490	08/89>09/94	5953.86		
	AR30750	1490	08/89>09/94	5953.86		
1.5 4x4	AR30146	1490	08/84>07/89	1508.83		
	AR30182	1490	08/84>07/89	1508.83		
1.5 AS	AS30508	1490	07/88>09/94	5953.86		
1.5 AS / 4x4	AR30520	1490	09/83>07/86	1508.83		
	AR30526	1490	08/85>07/89	1508.83		
1.5 AS Sport Wagon 4x4	AS30508	1490	07/88>07/89	1508.83		
1.5 DC	AR30504 / -514	1490	09/83>09/87	5953.86		
1.5 DC / 4x4	AR30504	1490	08/83>07/86	1508.83		
	AR30514	1490	08/83>07/86	1508.83		
1.5 Sport Wagon	AR30751	1490	08/89>09/94	5953.86		
1.7	AR30550	1712	08/89>09/94	5953.86		
	AR30550	1712	09/86>07/89	1508.83		
	AR30558	1712	08/87>07/89	5953.86		
1.7 16V	AR30747	1712	08/89>09/94	5953.86		
1.7 16V 4x4	AR30746	1712	08/89>09/94	5953.86		
1.7 16V Sport Wagon	AR60746	1712	08/89>09/94	5953.86		
1.7 Sport Wagon	AR30737	1712	08/89>09/94	5953.86		
	AR30740	1712	04/92>09/94	5953.86		
	AS30550	1712	07/88>07/89	5953.86		
1.7 Sport Wagon 4x4	AR30736	1712	08/89>09/94	5953.86		
	AS30558	1712	07/88>07/89	5953.86		

Alfa 75

1.6	AR06100	1570	05/85>05/93	6463.83		
	AR61101	1570	09/89>12/93	5964.83		
	AR61102	1570	09/89>12/93	5964.83		
1.8	AR06168	1779	09/88>12/93	5964.83		
	AR06202	1779	05/85>12/93	6463.83		
	AR61201	1779	09/88>12/93	5964.83		
	AR61202	1779	09/89>12/93	5964.83		



LISTE D'APPLICATIONS

APPLICATION LIST/ANWENDUNGSLISTE

VEHICULE MODEL FAHRZEUGTYP	MOTEUR ENGINE MOTOR	CYLINDRÉE ENGINE SIZE HUBRAUM	ANNÉE YEAR JAHR	VERNET
...Alfa 75				
1.8 Turbo	AR06158	1779	01/87>08/88	5964.83
	AR61203	1779	09/89>12/93	5964.83
1.8 Turbo VIN 162B1C	AR06134	1779	02/86>08/88	6463.83
1.8 Turbo VIN 162B1D	AR06134	1779	01/87>12/93	5964.83
2.0	AR06212	1962	05/85>07/87	6463.83
2.0 Twin Spark	AR06224	1962	06/87>12/93	5964.83
Alfa 90				
1.8	AR06202	1779	09/84>12/88	6463.83
2.0	AR01713	1962	09/84>12/88	6463.83
	AR06212	1962	09/84>12/88	6463.83
Alfa 145				
1.3	AR33501	1351	09/94>12/96	5953.86
1.4 16V Twin Spark	AR33503	1370	12/96>06/01	6568.83
1.6	AR33201	1596	09/94>12/96	5953.86
1.6 16V Twin Spark	AR32102	1598	06/98>06/01	6506.88
1.6 16V Twin Spark Chassis N°>165089 >3174688	AR67601	1598	12/96>06/01	6506.88
1.6 16V Twin Spark Chassis N°>165088 >3174687	AR67601	1598	12/96>01/00	6568.83
1.7 16V	AR33401	1712	09/94>12/96	5953.86
1.8	AR32201	1747	06/98>04/99	6506.88
1.8 16V Twin Spark	AR67106	1747	12/96>06/01	6490.83
	AR67199	1747	12/96>06/01	6490.83
1.8 16V Twin Spark AGV	AR32201	1773	06/98>04/99	6506.88
1.9 JTD	AR32302	1910	03/99>06/01	6551.88
1.9 TD	AR33601	1929	12/96>03/99	5975.80
1.9 TD (A/C)	AR33601	1929	12/96>03/99	6537.80
1.9 TD (A/C) MOT.1761923	AR67501	1929	09/94>	6574.80
1.9 TD (A/C) MOT.1761924	AR67501	1929	09/94>03/99	6255.80
1.9 TD MOT.1761923	AR67501	1929	09/94>	5688.80
1.9 TD MOT.1761924	AR67501	1929	09/94>03/99	6254.80
2.0 16V	AR67204	1970	12/96>06/01	6490.83
	AR67299	1970	12/96>06/01	6490.83
2.0 16V AGV	AR32301	1970	06/98>06/01	6506.88
Alfa 146				
1.3	AR33501	1351	12/94>12/96	5953.86
1.4 16V Twin Spark	AR33503	1370	12/96>06/01	6568.83
1.6	AR33201	1596	12/94>12/96	5953.86
1.6 16V Twin Spark VIN 930B2A	AR67601	1598	12/96>06/01	6568.83
1.6 16V Twin Spark VIN 930B2C	AR67601	1598	06/98>06/01	6506.88
1.7 16V	AR33401	1712	12/94>12/96	5953.86
1.8 16V Twin Spark	AR67106	1747	12/96>06/01	6490.83
1.8 16V Twin Spark AGV	AR32201	1773	06/98>06/01	6506.88
1.9 JTD	AR32302	1910	03/99>06/01	6551.88
1.9 TDs	AR33601	1929	12/96>06/01	5975.80
	AR67501	1929	12/96>06/01	5975.80
1.9 TDs (A/C)	AR33601	1929	12/96>06/01	6537.80
	AR67501	1929	12/96>06/01	6537.80
1.9 TDs (A/C) MOT.1761923	AR67501	1929	12/94>06/01	6574.80
1.9 TDs (A/C) MOT.1761924	AR67501	1929	12/94>06/01	6255.80
1.9 TDs MOT.1761923	AR67501	1929	12/94>06/01	5688.80
1.9 TDs MOT.1761924	AR67501	1929	12/94>06/01	6254.80
2.0 16V	AR67204	1970	12/96>06/01	6490.83
2.0 16V AGV	AR32301	1970	06/98>06/01	6506.88

PHOTOS PICTURES ZEICHNUNGEN	
 5688	 5953
 5964	 5975
 6254	 6255
 6463	 6490
 6506	 6537
 6551	 6568
 6574	



LISTE D'APPLICATIONS

APPLICATION LIST/ANWENDUNGSLISTE









VEHICULE MODEL FAHRZEUGTYP	MOTEUR ENGINE MOTOR	CYLINDRÉE ENGINE SIZE HUBRAUM	ANNÉE YEAR JAHR	VERNET
Alfa 147				
1.6 16V	AR32104	1598	10/00>	6506.88
	AR37203	1598	10/00>	6827.88
1.9 JTD	182B9.000	1910	03/01>	6826.88
	192A5.000	1910	12/02>09/04	6882.88
	192A5.000	1910	07/05>	6826.88
	937A2.000	1910	10/00>	6826.88
	937A4.000	1910	10/04>	6826.88
	937A4.000 / 5.000	1910	10/04>	6882.88
2.0 16V Selespeed	AR32310	1970	10/00>	6506.88
Alfa 155				
1.6 16V Twin Spark	AR67601	1598	04/96>08/97	6568.83
1.7 Twin Spark	AR67103	1749	11/91>07/98	5966.87
	AR67105	1749	11/91>03/95	5966.87
1.8 16V Twin Spark	AR67106	1747	04/96>08/97	6490.83
1.8 Twin Spark	AR67101	1773	11/91>03/95	5966.87
	AR67102	1773	11/91>03/95	5966.87
	AR67103	1749	03/95>08/97	5966.87
1.9 TD	160D100	1929	05/93>08/97	6254.80
	835A4000	1929	05/93>08/97	5688.80
	AR33601	1929	04/96>08/97	5975.80
	AR67501	1929	07/93>03/96	5975.80
1.9 TD (A/C)	160D200	1929	05/93>08/97	6255.80
	AR33601	1929	04/96>08/97	6537.80
	AR67501	1929	07/93>03/96	6537.80
2.0 16V Twin Spark	AR67204	1970	03/95>08/97	6490.83
	AR67299	1970	03/95>08/97	6490.83
2.0 Twin Spark	AR67201	1995	11/91>03/95	5966.87
	AR67202	1995	11/91>03/95	5966.87
2.5 TD	VM07B	2500	07/93>03/95	6570.80
	VM31B	2500	03/95>08/97	6570.80
Alfa 156				
1.6	AR32101	1598	09/97>03/03	6506.88
	AR32103	1598	09/00>03/03	6506.88
	AR67601	1598	09/97>03/03	6506.88
1.6 16V Twin Spark	AR32102	1598	09/97>	6506.88
	AR32103	1598	09/00>	6506.88
1.6 16V Twin Spark / Sport Wagon	AR32104	1598	09/00>	6506.88
	AR67601	1598	09/97>03/03	6506.88
1.8i 16V Twin Spark / Sport Wagon	AR32201	1773	09/97>03/03	6506.88
	AR32205	1747	09/00>	6506.88
1.9 JTD	AR37101	1910	09/00>03/03	6826.88
1.9 JTD Cross Wagon	937A5.000	1910	09/04>	6882.88
1.9 JTD MOT.>1415542	AR32302	1910	09/97>	6551.88
1.9 JTD MOT.1415541>	AR32302	1910	09/97>	6489.88
1.9 JTD Sport Wagon	937A2.000	1910	04/03>	6826.88
	937A4 / 192A5 / 192B	1910	11/02>03/03	6882.88
1.9 JTD Sport Wagon MOT.>1415542	AR32302	1910	09/97>	6551.88
1.9 JTD Sport Wagon MOT.1415541>	AR32302	1910	09/97>	6489.88
2.0 JTS 16V Twin Spark / Sport Wagon	932A2.000	1970	04/03>	6824.88
	937A1.000	1970	02/02>	6824.88
2.0 16 V Twin Spark / Sport Wagon	AR32310	1970	09/00>	6506.88
2.0 16V Twin Spark / Sport Wagon	AR32301	1970	09/97>03/03	6506.88





LISTE D'APPLICATIONS





APPLICATION LIST/ANWENDUNGSLISTE

VEHICULE MODEL FAHRZEUGTYP	MOTEUR ENGINE MOTOR	CYLINDRÉE ENGINE SIZE HUBRAUM	ANNÉE YEAR JAHR	VERNET	PHOTOS PICTURES ZEICHNUNGEN
...Alfa 156					
2.4 JTD / Sport Wagon	841C.000	2387	09/00>	6825.88	 1508
	841G	2387	04/03>	6882.88	
2.4 JTD / Sport Wagon MOT.1283805	839A6.000	2387	10/98>	6489.88	 5966
	AR32501	2387	09/97>	6489.88	
2.4 JTD / Sport Wagon MOT.1283806	839A6.000	2387	09/00>03/03	6551.88	 6489
	AR32501	2387	09/97>	6551.88	
Alfa 159 NEW					
1.9 GDi	939A6	1970	07/05>	6979.00	 6575
1.9 JTD / JTDM	939A1 / 939A2	1910	07/05>	6978.88	
2.2 GDi	939A5	2170	07/05>	6979.00	 6825
2.4 JTDM	939A3	2387	07/05>	6882.88	
Alfa 164					
2.0	AR64101	1997	10/90>09/92	1514.81	 6882
	AR64102	1997	10/90>09/92	1514.81	
	ARO6416	1962	10/90>09/92	5967.83	
	ARO6420	1962	07/87>09/92	5967.83	
	ARO6476	1995	07/87>09/92	1514.81	
2.0 Twin Spark	AR64103	1962	09/92>09/98	5966.87	 6978 NEW
Alfa 166					
2.0 16V Twin Spark	AR34103	1970	10/98>10/00	6575.88	 6979 NEW
	AR36301	1970	10/03>	6575.88	
2.4 JTD	839A6.000	2387	10/00>09/03	6826.88	
	841C.000	2387	10/03>	6826.88	
	841G.000	2387	10/03>	6882.88	
	841H.000	2387	10/03>	6882.88	
	AR34202	2387	10/98>10/00	6576.88	
Alfasud					
1.2 série I,II	AS30100	1186	11/71>12/86	1508.83	
	AS30110	1186	01/72>07/79	1508.83	
	AS30111	1186	01/77>12/79	1508.83	
1.2 série I,II,III	AS30102	1186	11/71>12/86	1508.83	
	AS30104	1186	11/73>	1508.83	
1.3 série I,II	AS30160	1351	12/78>12/86	1508.83	
	AS30180	1286	09/76>12/79	1508.83	
	AS30184	1286	09/76>07/79	1508.83	
	AS30190	1286	09/76>03/79	1508.83	
	AS30164	1351	09/78>	1508.83	
1.3 série I,II,III	AS30164	1351	09/78>	1508.83	
1.3 série III	AS30156	1351	01/80>12/86	1508.83	
	AS30168	1351	01/80>12/89	1508.83	
1.5 série I,II,III	AS30124	1490	12/78>12/89	1508.83	
	AS30126	1490	12/78>12/89	1508.83	
	AS30128	1490	01/80>12/89	1508.83	
1.5 série III	AS30133	1490	01/80>12/89	1508.83	
	AS30146	1490	01/80>12/89	1508.83	
	AS30198	1490	01/80>12/89	1508.83	
1.7	AR30550 / 558	1712	04/88>12/89	1508.83	
Alfasud Sprint					
1.3 Sprint	AS30168	1351	01/80>	1508.83	



LISTE D'APPLICATIONS





APPLICATION LIST/ANWENDUNGSLISTE

VEHICULE MODEL FAHRZEUGTYP	MOTEUR ENGINE MOTOR	CYLINDRÉE ENGINE SIZE HUBRAUM	ANNÉE YEAR JAHR	VERNET	PHOTOS PICTURES ZEICHNUNGEN
...Alfasud Sprint					
1.5 Sprint	AR30146	1490	01/80>	1508.83	 1508
	AR30182	1490	04/80>12/87	1508.83	
	AR30198	1490	01/80>	1508.83	
	AR30520	1490	04/80>12/87	1508.83	
	AS30126	1490	01/80>12/88	1508.83	
	AS30128	1490	07/79>12/88	1508.83	
	AS30133	1490	01/80>12/88	1508.83	
1.7 Sprint	AR30550	1712	04/88>	1508.83	 6490
	AR30558	1712	04/88>	1508.83	
Alfetta					
1.6	AR01600	1570	01/75>11/85	6463.83	 6490
1.8	AR01608	1779	05/72>06/81	6463.83	
	AR01678	1779	02/81>11/85	6463.83	 6506
2.0	AR01334	1962	07/80>11/83	6463.83	
	AR01605 / -615	1962	07/78>12/81	6463.83	
	AR01623	1962	05/76>11/85	6463.83	
	AR01629	1962	05/76>12/85	6463.83	
	AR01655	1962	05/76>11/85	6463.83	
	AR01674	1962	07/78>11/85	6463.83	
Arna					
1.2	AR30500	1189	11/84>11/87	1508.83	 6979
	AR31000	1186	09/83>12/84	1508.83	
1.3	AR30512	1351	11/84>11/87	1508.83	NEW
	AR31006	1351	09/83>11/87	1508.83	
	AR31010	1351	09/83>11/87	1508.83	
1.5	AR30520	1490	09/83>11/87	1508.83	
Brera NEW					
2.2 JTS	939A5.	2170	12/05>	6979.00	
2.4 JTD M200	939A3.	2387	12/05>	6882.88	
Giulietta					
1.3	AR01644	1357	01/78>06/83	6463.83	
1.6	AR01600	1570	10/77>06/86	6463.83	
1.8	AR01678	1779	03/79>04/86	6463.83	
2.0	AR01655	1962	08/79>04/86	6463.83	
	ARO1699	1962	01/81>12/86	6463.83	
GT NEW					
1.8	AR32205	1747	01/04>	6506.88	
1.9 JTD	937A5.	1910	09/03>	6882.88	
2.0 JTS	932A2 / 937A1	1970	09/03>	6824.88	
GTV					
1.8 16V Twin Spark	AR32201	1773	05/98>02/03	6506.88	
2.0 16V Twin Spark	AR16201	1970	03/95>08/00	6490.83	
	AR32310 / AR32210	1970	08/00>	6506.88	
2.0 16V Twin Spark AGV	AR32301	1970	05/98>02/03	6506.88	
2.0 JTS 16V	937A1.000	1970	03/03>	6824.88	
Spider					
1.6	AR01563	1570	01/90>12/93	6463.83	
1.8 16V Twin Spark	AR32201	1970	02/95>02/03	6506.88	
2.0 16V Twin Spark	AR16201	1970	02/95>05/98	6490.83	
	AR32301 / AR32310	1970	05/98>	6506.88	
2.0 JTS 16V	937A1.000	1970	03/03>	6824.88	



LISTE D'APPLICATIONS

APPLICATION LIST/ANWENDUNGSLISTE

VEHICULE MODEL FAHRZEUGTYP	MOTEUR ENGINE MOTOR	CYLINDRÉE ENGINE SIZE HUBRAUM	ANNÉE YEAR JAHR	VERNET	PHOTOS PICTURES ZEICHNUNGEN
AUDI					
50					
1.1	HB / HC / HD	1093	08/74>07/78	1410.87	
1.3	HH	1272	08/77>07/78	1410.87	
	HH	1272	08/78>09/81	1410.92	
80					
1.3	EP	1297	08/81>07/84	1439.87	
	FY / FZ	1272	09/78>07/81	1410.87	
	ZA / ZF	1272	05/72>07/78	1439.87	
1.4	SE	1405	09/86>07/88	1439.87	
1.6	ABB / ABM / ADA	1595	08/92>07/95	1439.87	
	DT / DTA / JU	1595	08/83>08/86	1439.87	
	HY	1588	08/77>08/80	1439.87	
	PP / SA / RN / RNA	1595	09/86>08/91	1439.87	
	SA	1595	08/95>08/86	3349.87	
	WP / WV / WVA / WY / WZ	1588	08/78>07/83	1439.87	
	YG / YH / YK	1588	08/77>07/80	1439.87	
	YN / YP / YS / YT	1588	09/75>07/83	1439.87	
	YP / YZ	1595	08/81>08/83	1439.87	
	YW / YY / YZ	1588	09/78>07/82	1439.87	
1.6 Avant	ABB / ADA	1595	08/92>05/93	1439.87	
1.6 D	CR / JK	1588	08/81>07/89	3349.87	
1.6 TD	CY / RA / SB	1588	02/82>07/91	3349.87	
1.7	WT	1715	08/80>07/83	1439.87	
1.8	DS / JV	1781	01/83>07/88	1439.87	
	DZ / JN / MU / PM / PV	1781	08/81>09/91	1439.87	
	NE / RU / SF	1781	09/86>08/91	1439.87	
1.8 Quattro	DZ / JN / MU / PV	1781	08/84>09/91	1439.87	
	JV	1781	08/83>08/86	1439.87	
	NE / SF	1781	08/84>07/90	1439.87	
1.9	SD	1857	08/86>07/89	1439.87	
	WN	1921	08/81>07/83	5968.87	
1.9 D	1Y	1896	08/89>07/95	3349.87	
1.9 Quattro	SD	1857	09/86>07/88	1439.87	
1.9 TD / TD Avant	AAZ	1896	09/91>06/93	3349.87	
1.9 TDi / TDi Avant	1Z	1896	09/91>07/95	3349.87	
2.0	3A	1984	08/88>08/91	1439.87	
	6A / ABK / ACE / ADW	1984	09/91>06/95	1439.87	
	AAD / ABT	1984	08/90>06/95	1439.87	
	JS / HP / JL	1994	08/82>08/86	5968.87	
	SK	1994	02/86>12/90	5968.87	
2.0 Avant	ABK / ABT / ACE / ADW	1984	07/93>06/95	1439.87	
2.0 Quattro	3A	1984	08/88>07/90	1439.87	
	6A / ABK / ACE / ADW	1984	03/90>06/95	1439.87	
	JS	1994	08/83>07/84	5968.87	
2.2	WE	2144	10/80>07/83	5968.87	
2.2 Quattro	KK / KL	2144	08/82>07/84	5968.87	
2.2 Quattro Turbo	ABY / ADU	2226	02/93>06/95	5968.87	
2.3 Avant / Quattro	NG	2309	08/91>06/95	5968.87	
2.6 Quattro V6	ABC / ACZ	2598	07/92>07/95	5902.87	
2.6 V6 / Avant V6	ABC / ACZ	2598	08/92>07/95	5902.87	
2.8 Quattro V6	AAH	2771	08/92>06/95	5902.87	



LISTE D'APPLICATIONS

APPLICATION LIST/ANWENDUNGSLISTE

VEHICULE MODEL FAHRZEUGTYP	MOTEUR ENGINE MOTOR	CYLINDRÉE ENGINE SIZE HUBRAUM	ANNÉE YEAR JAHR	VERNET
...80				
2.8 V6 / Avant V6	AAH	2771	09/91>07/95	5902.87
90				
1.6 TD	CY	1588	10/84>07/86	3349.87
	RA / SB	1588	04/88>12/92	3349.87
1.8	DZ	1781	08/89>12/92	3349.87
	JN	1781	06/84>07/86	3349.87
2.0	JS / HP / JL	1994	10/84>07/86	5968.87
	PS	1994	08/84>12/91	5968.87
2.0 20V / Quattro 20V	NM	1994	01/88>12/92	5968.87
2.2	HY / KV / KX / KY	2226	10/84>07/86	5968.87
	KV	2226	04/87>12/92	5968.87
2.2 Quattro	HY / JT / KV	2226	08/84>12/91	5968.87
2.3	NG	2309	04/87>12/92	5968.87
2.3 20V / Quattro 20V	7A	2309	06/88>12/91	5968.87
2.3 Quattro	NG	2309	04/87>12/91	5968.87
100				
1.6	ABB / ADA	1595	03/92>07/94	1439.87
	YM	1588	08/74>05/76	1400.83
	YM	1588	08/74>05/76	1400.87
	YV	1588	08/76>07/81	1439.80
1.6 Avant	ABB / ADA	1595	03/92>07/94	1439.87
	YV	1588	08/76>07/82	1439.87
1.8	059.3 / ZM / ZV / ZZ	1760	07/68>07/84	1400.83
	4B / PH / RS / SH	1781	04/85>07/90	1439.87
	DR / DS	1781	08/82>07/89	1439.87
	JW	1781	03/83>07/90	1439.87
	NP	1781	01/88>12/90	1439.87
	ZU	1760	08/71>07/74	1400.83
1.8 Avant	DR / DS	1781	08/82>07/89	1439.87
	JW	1781	08/82>07/89	5968.87
1.8 Avant / Quattro	4B / PH / RS / SH	1781	04/85>12/90	1439.87
	NP	1781	10/84>07/89	1439.87
1.8 Quattro	JW	1781	05/83>07/89	1439.87
1.9	WH	1921	08/79>07/84	5968.87
	ZJ / ZN / ZX	1871	09/68>05/76	1400.83
1.9 Avant	WH	1921	08/80>07/84	5968.87
2.0	AAD	1984	12/90>07/92	1439.87
	AAD / AAE / ABK	1984	12/90>07/94	1439.87
	ADW	1984	12/93>07/94	1439.87
	KP / SL / RT	1994	01/88>12/90	5968.87
	WA / WF	1984	07/77>07/78	1400.83
2.0 16V Avant Quattro	ACE	1984	01/92>07/94	1439.87
2.0 Avant	AAD / AAE / ABK	1984	12/90>07/94	1439.87
	KP / SL / RT	1994	08/84>07/90	5968.87
2.0 Avant 16V / Quattro 16V	ACE	1984	01/92>07/94	1439.87
2.0 D	CN	1986	06/76>07/89	5968.87
2.0 D Avant	CN	1986	09/79>07/89	5968.87
2.0 TD	DE / NC	1986	01/88>12/90	5968.87
2.0 TD Avant	DE / NC	1986	08/82>07/90	5968.87
2.1	WE	2144	03/77>07/81	1535.80



1400



1439



1535



3349



5902











5968



LISTE D'APPLICATIONS

APPLICATION LIST/ANWENDUNGSLISTE











VEHICULE MODEL FAHRZEUGTYP	MOTEUR ENGINE MOTOR	CYLINDRÉE ENGINE SIZE HUBRAUM	ANNÉE YEAR JAHR	VERNET	PHOTOS PICTURES ZEICHUNGEN
...100					
2.2	HX / KZ / KU / MC	2226	08/84>07/90	5968.87	
	KF / WU	2226	05/83>07/84	5968.87	
	WC	2144	05/83>12/87	5968.87	
	WC / WE	2144	03/77>07/82	1439.80	
	WC / WE / WG	2144	06/77>07/82	1535.80	
	WU	2226	05/83>07/84	5968.87	
2.2 (VIN 433151)	WB	2144	08/76>07/84	1535.80	
2.2 (VIN 433153)	WB	2144	08/76>07/84	5968.87	
2.2 Avant	WC	2144	08/76>07/90	5968.87	
2.2 Avant (VIN 433151)	WB	2144	04/76>07/84	1535.80	
2.2 Avant (VIN 433153)	WB	2144	04/77>07/84	5968.87	
2.2 Avant / Quattro	HX / KU / MC / PX	2226	08/86>12/90	5968.87	
2.2 Quattro	AAN	2226	08/86>12/90	5968.87	
	AAN	2226	08/91>07/94	5968.87	
2.3	AAR	2309	12/90>07/94	5968.87	
	NF	2309	10/86>12/90	5968.87	
2.3 Avant / Quattro	AAR	2309	12/90>07/94	5968.87	
	NF	2309	08/86>12/90	5968.87	
2.4 D	3D / AAS	2370	08/90>07/94	5968.87	
2.4 D Avant	3D / AAS	2370	08/89>07/94	5968.87	
2.5 TDi	1T	2460	08/89>12/90	5968.87	
2.5 TDi 5+E	ABP / AAT	2460	06/91>07/94	5968.87	
2.5 TDi Avant	1T	2460	01/90>07/90	5968.87	
2.5 TDi Avant 5+E	ABP / AAT	2460	10/91>07/94	5968.87	
2.6 Avant V6 / Quattro V6	ABC	2598	04/92>07/94	5902.87	
2.6 V6	ABC / ACZ	2598	04/92>07/94	5902.87	
2.8 Avant V6 / Quattro V6	AAH	2771	12/90>07/94	5902.87	
2.8 V6	AAH	2771	12/90>07/94	5902.87	
4.2 Quattro Avant Quattro	ABH	4172	10/92>07/94	5902.87	
200					
2.0 TD	WB	1986	08/84>11/90	5968.87	
2.1	KH	2144	08/83>11/90	5968.87	
	KJ / WS	2144	08/80>07/85	5968.87	
	WC / WJ / WK	2144	10/79>07/85	5968.87	
2.1 Quattro Turbo / Avant Quattro Turbo	JY / KG	2144	10/84>01/88	5968.87	
2.1 Turbo	JY / KG	2144	08/83>01/88	5968.87	
2.2	KU	2226	08/84>07/85	5968.87	
2.2 Quattro Turbo / Avant Quattro Turbo	1B / MC	2226	01/85>11/90	5968.87	
2.2 Turbo	1B / 2B / MC	2226	08/85>12/90	5968.87	
2.3 Avant Quattro Turbo 20V	3B	2309	03/89>11/90	5968.87	
2.3 Quattro Turbo 20V	3B	2309	03/89>11/90	5968.87	
2.3 Turbo 20V	3B	2309	08/88>12/90	5968.87	
3.0 / 3.0 Quattro	BJ	2909	12/90>12/91	5968.87	
A2					
1.2 TDi	ANY / AYZ	1191	03/01>08/05	6273.87	
1.4	AUABBY	1405	03/01>08/05	6274.87	
1.4 TDi	AMF / ATL / BHC	1422	06/00>08/05	6273.87	
1.6 FSI	BAD	1595	05/02>08/05	6968.00	
A3					
1.6	AEH / AKL	1595	09/96>06/03	6276.87	
	APF / AVU / BFQ	1595	08/98>08/05	6976.00	
	AVU	1595	09/00>06/03	6276.87	
	BFQ / BGU	1595	05/02>	6276.87	
1.6 Sportback	BUG / BSE / BSF	1595	05/03>	6276.87	





LISTE D'APPLICATIONS











APPLICATION LIST/ANWENDUNGSLISTE

VEHICULE MODEL FAHRZEUGTYP	MOTEUR ENGINE MOTOR	CYLINDRÉE ENGINE SIZE HUBRAUM	ANNÉE YEAR JAHR	VERNET	PHOTOS PICTURES ZEICHNUNGEN
...A3					
1.6 FSI	BLF / BLP / BAG	1598	08/03>	6965.00	
1.8 20V	AGN	1781	09/96>06/01	6276.87	
	APG / AUM	1781	09/00>06/03	6276.87	
1.8 20V Turbo	AUQ	1781	09/00>06/03	6276.87	
1.8 20V Turbo / Quattro 20V Turbo	AGU	1781	12/96>06/03	6276.87	
	AJQ / AQA / APP / AUM	1781	08/98>06/03	6276.87	
	ARX / ARY	1781	09/00>06/03	6276.87	
1.9 TDi	AGR / AHF	1896	09/96>04/02	6273.87	
	ALH	1896	08/97>06/01	6273.87	
	ASV	1896	08/98>06/01	6273.87	
	ATD / AXR	1896	01/01>06/03	6273.87	
	BKC	1896	08/04>	6273.87	
1.9 TDi / Quattro TDi	ASZ	1896	09/00>06/03	6273.87	
2.0 FSI	AXW	1984	05/03>	6864.105	
	BVY / BVZ	1984	11/05>	6864.105	
	BVY / BVZ	1984	11/05>	6977.00	
2.0 FSI Sportback	BLR / BLX / BLY / BMB	1984	09/04>10/05	6864.105	
2.0 Quattro	AXX / BWA	1984	09/04>	6977.00	
2.0 Quattro	BWA	1984	09/05>	6864.105	
2.0 Quattro	AXX / BWA	1984	09/04>	6975.00	
	AXX / BWA	1984	09/04>	6976.00	
2.0 Sportback Quattro	BMM	1968	01/06>	5962.88	
2.0 TDi / Sportback TDi	AZV / BKD / BMM	1968	05/03>	5962.88	
2.0 TDi Quattro	BMM	1968	01/05>	6273.87	
	BMM	1968	01/06>	6975.00	
	BMM	1968	01/06>	6976.00	
2.0 Turbo FSI	AXX	1984	09/05>	6977.00	
3.2	BUB	3200	11/05>	6533.80	
3.2 FSI V6 Quattro	BDB	3189	09/05>	6533.80	
3.2 Quattro	BMJ	3189	09/04>	6975.00	
	BMJ	3189	09/04>	6976.00	
	BUB	3200	11/05>	6975.00	
3.2 V6 24V	BDB / BMJ	3189	07/03>10/05	6533.80	
A4					
1.6	ADP	1595	11/94>09/96	6276.87	
	AHL	1595	10/96>07/99	6276.87	
	ANA / ARM	1595	08/98>11/00	6276.87	
1.6 Avant	ADP	1595	11/94>10/96	6276.87	
	AHL	1595	10/96>11/00	6276.87	
	ALZ	1595	12/00>	6842.105	
	ANA / ARM	1595	08/98>07/99	6276.87	
1.8 20V / Avant 20V	ADR / AFY	1781	11/94>11/00	6276.87	
	APT / ARG	1781	08/98>11/00	6276.87	
1.8 20V Turbo / Avant 20V Turbo	AEB / ARK	1781	11/94>07/99	6276.87	
	AJL / ANB / APU	1781	10/97>12/00	6276.87	
1.8 Avant Quattro 20V Turbo	AEB / ARK	1781	02/96>12/98	6276.87	
	AJL / ANB / APU	1781	10/97>12/00	6276.87	
	AMB	1781	07/01>12/02	6273.87	
1.8 cabriolet	BFB	1781	07/02>01/06	6842.100	
1.8 Quattro	AWT	1781	06/00>10/00	6273.87	
1.8 Quattro 20V / Avant Quattro 20V	ADR / AFY / AVJ / BEX	1781	02/96>11/00	6276.87	
	APT / ARG	1781	08/98>11/00	6276.87	
1.8 Quattro 20V Turbo	AEB / ARK	1781	11/94>12/98	6276.87	
	AJL / ANB / APU	1781	10/97>12/00	6276.87	



LISTE D'APPLICATIONS













APPLICATION LIST/ANWENDUNGSLISTE

VEHICULE MODEL FAHRZEUGTYP	MOTEUR ENGINE MOTOR	CYLINDRÉE ENGINE SIZE HUBRAUM	ANNÉE YEAR JAHR	VERNET	PHOTOS PICTURES ZEICHNUNGEN
...A4					
1.9 D	AFF	1896	03/96>07/98	6273.87	 5902
1.9 TDI	BKE / BRB	1896	06/04>11/05	6273.87	 5962
1.9 TDi / Avant TDi	1Z	1896	11/94>07/97	6273.87	
	AFN / AHH / AHU / AJM	1896	02/96>11/00	6273.87	
	AVB / AVF	1896	04/01>12/04	6273.87	
1.9 TDi avant Quattro	ATJ / AVG	1896	08/99>11/00	6273.87	
1.9 TDi Multitronic / Avant Multitronic	AWX	1896	12/00>06/03	6273.87	 5968
1.9 TDi Quattro	AVG	1896	08/99>11/00	6273.87	 6273
1.9 TDi Quattro / Avant Quattro	AFN	1896	02/96>11/00	6273.87	
2.0 FSi / Avant	AWA	1984	07/02>12/04	6842.105	
2.0 FSi / Avant / Avant Quattro / Quattro	BGB / BWE	1984	11/04>	6988.00	 6533
2.0 FSi Quattro	BUL	1996	11/04>	6988.00	 6842
2.0 Multitronic / Avant Multitronic	ALT	1984	12/00	6842.100	
2.0 TDi	BPW / BRC	1968	11/04>01/06	5962.88	
2.0 TDi Avant	BLB / BNA	1968	11/04>11/05	5962.88	
	BRE / BRF / BVF / BVG	1968	10/05>	5962.88	
2.0 TFSi	BWE	1984	01/06>	5962.88	
2.4 V6 / avant quattro	AML	2393	08/98>12/98	5902.87	 6955
2.4 Quattro V6	AML / APS / APZ / ARJ	2393	07/99>11/00	6533.92	 6988
2.4 Quattro V6 / Avant Quattro V6	AGA / AJG / ALF	2393	08/97>07/98	5902.87	
	AML / APS / APZ / ARJ	2393	08/98>06/99	5902.87	
2.4 V6 / Avant V6	AFM	2393	07/95>07/97	5902.87	
	AGA / AJG / ALF	2393	08/97>07/98	5902.87	
	APS / APZ / ARJ	2393	08/98>06/99	5902.87	
	APS / APZ / ARJ	2393	07/99>11/00	6533.92	
2.4 V6 Multitronic / Avant V6 Multitronic	AMM / BVD	2393	09/01>	6533.92	
2.5 Avant Quattro	BAU / BDH	2496	11/02>12/04	5902.87	 6989
2.5 TDi	AAT	2460	07/95>11/00	5968.87	 6994
2.5 TDi Avant	BFC	2496	07/02>05/03	5902.87	
2.5 TDi Avant Quattro	BAU / BDH	2496	11/02>12/04	5902.87	
2.5 TDi Avant V6 / Quattro V6 / Avant Quattro V6	AKE / BFC	2496	12/00>05/03	5902.87	
	BCZ / BDG	2496	06/03>05/06	5902.87	
2.5 TDi Avant V6 Multitronic	AYM	2496	09/01>06/02	5902.87	
2.5 TDi Quattro V6 / Avant Quattro V6	AFB / AKN	2496	11/97>11/00	5902.87	
2.5 TDi V6 / Avant V6 TDi	AFB / AKN	2496	11/97>11/00	5902.87	
2.5 TDi V6 Multitronic	AYM	2496	04/01>06/02	5902.87	
2.6 Quattro V6 / Avant Quattro V6	ABC / ACZ	2598	11/94>12/98	5902.87	
2.6 V6 / Avant V6	ABC / ACZ	2598	11/94>12/98	5902.87	
2.7 Quattro	AGB	2671	02/99>10/00	5902.87	
2.7 TDi / Avant	BPP / BSG	2698	11/05>	6994.87	
2.8 Avant Quattro V6 30V	ACK / ALG / APR / AQD	2771	04/96>12/98	5902.87	
2.8 Quattro V6 30V	ACK / ALG / APR / AQD	2771	01/99>11/00	5902.87	
2.8 V6 / Quattro V6	AAH	2771	11/94>07/97	5902.87	
2.8 V6 30V / Avant V6 30V	ACK / ALG / APR / AQD	2771	02/96>06/99	5902.87	
	APR / AMX / AQD / ATX	2771	03/99>11/00	6533.92	
3.0 / Avant / Avant Quattro / Quattro	ASN / BBJ	2976	12/00>12/05	6955.92	
3.0 / Avant Quattro / Quattro	AVK	2976	09/01>06/02	6955.92	
3.0 TDi Avant Quattro / Quattro	ASB / BKN	2967	11/04>	6994.87	
3.2 FSi / Avant / Avant Quattro / Quattro	AUK	3123	01/05>	6989.00	



LISTE D'APPLICATIONS



APPLICATION LIST/ANWENDUNGSLISTE

VEHICULE MODEL FAHRZEUGTYP	MOTEUR ENGINE MOTOR	CYLINDRÉE ENGINE SIZE HUBRAUM	ANNÉE YEAR JAHR	VERNET	PHOTOS PICTURES ZEICHUNGEN
A6					
1.8 20V / Avant 20V	ADR / AFY / AJP / AQE / ARK	1781	07/95>05/01	6276.87	 1439
1.8 20V Turbo / Avant 20V Turbo	AEB / AJL / ANB / APU	1781	04/97>05/01	6276.87	 3349
1.8 Avant	ARH	1781	01/99>01/05	6276.87	
1.8 Avant / Quattro / Avant Quattro 20V Turbo	AWT	1781	06/01>04/05	6276.87	
1.8 Avant Quattro 20V (VIN 4A50C5)	ADR	1781	07/95>09/97	5902.87	 5902
1.8 Avant Quattro 20V (VIN 4A50L5)	ADR / ARK	1781	07/95>05/99	6276.87	 5962
1.8 Avant Quattro 20V Turbo	AEB / AJL / ANB / APU	1781	02/98>05/01	6276.87	
1.8 Quattro 20V	ADR / ARK	1781	07/95>05/99	6276.87	
1.8 Quattro 20V Turbo	AEB / AJL / ANB / APU	1781	04/97>05/01	6276.87	
1.9	AVG	1896	08/99>01/05	6273.87	
1.9 TDi / Avant TDi	1Z	1896	07/94>06/96	3349.87	
	AFN	1896	04/97>05/01	6273.87	
	AHU	1896	07/96>03/97	3349.87	
	AJM	1896	01/98>05/01	6273.87	
1.9 TDi Multitronic / Avant TDi Multitronic	AVF / AWX	1896	06/01>04/05	6273.87	 5968
2.5 TDi / Avant TDi	AYM / BFC	2496	06/01>08/03	5902.87	 6273
2.0	AAE / ABK / ADW	1984	07/94>09/97	1439.87	
2.0 16V / Avant 16V	ACE	1984	07/94>09/97	1439.87	
2.0 Avant	ABK / ADW	1984	07/94>09/97	1439.87	
	ALT	1984	06/01>04/05	6842.100	 6276
2.0 Quattro 16V / Avant Quattro 16V	ACE	1984	06/94>09/97	1439.87	 6533
2.0 TDi avant	BLB	1968	06/05>11/05	5962.88	
	BNA	1996	06/05>11/05	5962.88	
	BRE / BRF / BVG	1968	06/05>	5962.88	
2.0 TFSi / Avant	BPJ	1984	06/05>	6988.00	 6842
2.3	AAR	2309	07/94>09/97	5968.87	 6967 NEW
2.3 Avant / Avant Quattro	AAR	2309	07/94>09/97	5968.87	
2.4	ARN	2393	01/99>05/99	5902.87	
	ARN	2393	06/99>05/01	6533.92	
2.4 / Avant / Avant Quattro / Quattro	BDW	2393	04/04>	6989.00	
2.4 Avant Quattro V6 (Chassis 4BX-160-000)	APS / APZ / ARJ	2393	04/98>	5902.87	
2.4 Avant Quattro V6 (Chassis 4BX-160-001)	APS / APZ / ARJ	2393	04/98>	6533.92	 6988 NEW
2.4 Avant V6 (Chassis 4BX-160-000)	APC / APS / APZ / ARJ	2393	04/98>	5902.87	 6989 NEW
2.4 Avant V6 (Chassis 4BX-160-001)	APC / APS / APZ / ARJ	2393	04/98>	6533.92	
2.4 Avnt Quattro	AML / APC / APS / Z / ARJ	2393	11/98>05/99	6533.92	
2.4 Quattro V6 (Chassis 4BX-160-000)	APS / APZ / ARJ	2393	04/98>	5902.87	
2.4 Quattro V6 (Chassis 4BX-160-001)	APS / APZ / ARJ	2393	04/98>	6533.92	
2.4 Quattro V6 / Avant Quattro V6	AGA / AJG / ALF / APC	2393	04/97>01/99	5902.87	
2.4 V6 (Chassis 4BX-160-000)	APC / APS / APZ / ARJ	2393	04/98>	5902.87	
2.4 V6 (Chassis 4BX-160-001)	APC / APS / APZ / ARJ	2393	04/98>05/01	6533.92	
2.4 V6 / Avant V6	AFM / AGA / AJG / ALF / ALW	2393	07/95>01/99	5902.87	
2.4 V6 30V / Avant V6 30V / Quattro V6 / Avant Quattro V6	AMM / ASM / BDV	2393	06/01>05/04	6533.92	
2.5 TDi	BAU / BCZ	2496	06/03>08/05	6967.87	
2.5 TDi / Avant TDi	AAT / AEL	2460	07/94>09/97	5968.87	
2.5 TDi Allroad V6	AKE / BAU / BDH	2496	05/00>05/04	5902.87	
2.5 TDi Avant	BCZ / BDG	2496	02/03>01/05	5902.87	
2.5 TDi Quattro / Avant Quattro	AEL	2460	07/95>09/97	5968.87	



LISTE D'APPLICATIONS

APPLICATION LIST/ANWENDUNGSLISTE

VEHICULE MODEL FAHRZEUGTYP	MOTEUR ENGINE MOTOR	CYLINDRÉE ENGINE SIZE HUBRAUM	ANNÉE YEAR JAHR	VERNET	PHOTOS PICTURES ZEICHNUNGEN
...A6					
2.5 TDi Quattro V6 / Avant Quattro V6 TDi	AFB / AKN	2496	07/97>05/01	5902.87	 
2.5 TDi V6 / Avant V6 TDi	AFB / AKN	2496	04/97>05/01	5902.87	
2.6 Quattro V6 / Avant Quattro V6	ABC / ACZ	2598	06/94>09/97	5902.87	
2.6 V6 / Avant V6	ABC / ACZ	2598	07/94>09/97	5902.87	
2.7 Allroad V6 Turbo	ARE / BES	2671	04/05>	5902.87	
2.7 Avant Quattro	AZA	2671	09/00>05/01	5902.87	
2.7 Avant Quattro V6 Bi turbo	AJK	2671	03/98>05/01	5902.87	
2.7 Quattro V6 Bi turbo	AJK	2671	03/98>05/01	5902.87	
2.7 TDi / Avant	BPP / BSG	2698	11/04>04/05	6994.87	
2.7 V6 Bi Turbo / Avant V6 Bi Turbo	AJK	2671	01/98>05/01	5902.87	
2.8 Avant Quattro	AMX	2771	06/00>05/01	6533.92	
	ATX / AQD	2771	07/99>01/05	6533.92	
2.8 Avant Quattro V6 30V	ACK / ALG	2771	07/95>01/99	5902.87	
2.8 Avant Quattro V6 30V (Chassis 4BX-160-000)	AGE / APR / AQD	2771	04/98>	5902.87	
2.8 Avant Quattro V6 30V (Chassis 4BX-160-001)	AGE / APR / AQD	2771	04/98>	6533.92	
2.8 Avant V6 30V (Chassis 4BX-160-000)	AGE / APR / AQD	2771	04/98>05/99	5902.87	
2.8 Avant V6 30V (Chassis 4BX-160-001)	AGE / APR / AQD	2771	04/98>	6533.92	
2.8 Quattro V6 / Avant Quattro V6	AAH / AEJ	2771	06/94>09/97	5902.87	
2.8 Quattro V6 30V	ACK / ALG	2771	07/95>01/99	5902.87	
2.8 Quattro V6 30V (Chassis 4BX-160-000)	AGE / APR / AQD	2771	04/98>	5902.87	
2.8 Quattro V6 30V (Chassis 4BX-160-001)	AGE / APR / AQD	2771	04/98>	6533.92	
2.8 V6 / Avant V6	AAH / AEJ	2771	07/94>09/97	5902.87	
2.8 V6 30V (Chassis 4BX-160-000)	AGE / APR / AQD	2771	04/98>	5902.87	
2.8 V6 30V (Chassis 4BX-160-001)	AGE / APR / AQD	2771	04/98>	6533.92	
2.8 V6 30V / Avant V6 30V	ACK / ALG	2771	10/95>01/99	5902.87	
3.0 / Avant / Avant Quattro / Quattro	ASN / BBJ	2976	06/01>04/05	6955.92	
3.0 TDi / Avant Quattro / Quattro	BMK	2967	04/04>04/05	6994.87	
3.0 TDi Avant Quattro / Quattro	BNG	2967	04/04>04/05	6994.87	
3.2 FSi / Avant / Avant Quattro / Quattro	AUK	3123	04/04>	6989.00	
4.2	BAS	4172	09/02>08/05	6967.87	
4.2 Quattro V6 30V / Avant Quattro V6 30V	ASG / ARS	4172	04/99>05/01	6529.87	
A8					
2.5 TDi	AAT	2460	07/95>	5968.87	
2.5 TDi V6 / V6 Quattro DTi	AFB / AKN / AKE	2496	06/97>09/02	5902.87	
2.8 V6 / V6 Quattro	AAH / AEJ	2771	06/94>03/96	5902.87	
2.8 V6 30V	APR / AQD	2771	10/98>02/01	5902.87	
2.8 V6 30V / V6 30V Quattro	ACK / ALG	2771	07/95>12/98	5902.87	
2.8 V6 30V Quattro (Chassis 4BX-160-000)	APR / AQD	2771	01/99>	5902.87	
2.8 V6 30V Quattro (Chassis 4BX-160-001)	APR / AQD / AMX	2771	01/99>09/02	6533.92	
3.0 TDi Quattro	ASB / BNG	2967	11/03>	6994.87	
3.2 FSi / Quattro	BPK	3123	06/05>	6989.00	
3.3 TDi Quattro V8	AKF	3328	12/99>09/02	5902.87	
3.7 V8 / V8 Quattro	AEW / AKJ / AQG	3697	10/95>12/98	5902.87	
	AKC / AQG	3697	10/98>09/02	6529.82	
	BFL	3697	11/02>	6529.82	



5902



5968



6529



6533



6955

NEW



6967

NEW



6989

NEW

















6994

NEW



LISTE D'APPLICATIONS















APPLICATION LIST/ANWENDUNGSLISTE

VEHICULE MODEL FAHRZEUGTYP	MOTEUR ENGINE MOTOR	CYLINDRÉE ENGINE SIZE HUBRAUM	ANNÉE YEAR JAHR	VERNET	PHOTOS PICTURES ZEICHNUNGEN
...S6					
4.2 Quattro / Avant Quattro V8 32V / Plus	AEC / AHK	4172	07/94>10/97	5902.87	 1519
S8					
4.2 Quattro V8	AHC / AKH	4172	09/96>12/98	5902.87	 1522
	AQH	4172	05/99>02/01	6529.82	
	AVP / AYS / BCS	4172	09/00>09/02	6529.82	
TT					
1.8 Quattro	BFV	1781	03/05	6276.87	 5069
1.8 Turbo 20V / Quattro Turbo 20V	AJQ / APP / APX	1781	10/98>10/01	6276.87	 5902
	ARY / AUM / AUQ / BAM	1781	09/00>	6276.87	
3.2 V6	BHE	3189	07/03>	6533.80	
V8					
3.6 V8	PT / PT-K	3562	10/88>07/93	5902.87	 5973
4.2 V8	ABH	4172	10/91>07/93	5902.87	 6276
AUTOBIANCHI					
A112					
1.0	A112AB2C0	1049	06/75>12/85	1522.87	
903	A112A000	903	07/79>06/84	1522.87	
	A112A200	903	10/69>12/85	1522.87	
965	A112B1000	965	10/72>07/85	1522.87	 6284
982	A112A1000	982	09/71>12/75	1522.87	 6495
Y10					
1.0	156A2.100	999	03/89>09/92	5069.87	
1.0 (1000)	156A3.000	999	09/86>12/88	1519.82	
1.0 4WD	156A2.000 / .246	999	01/89>09/92	5069.87	 6529
1.0 Touring	156A.000	1049	07/85>12/88	1519.82	 6533
1.0 Turbo	156A1.000	1049	07/85>12/88	1519.82	
1.1 / 4WD	176B2.000	1108	01/95>10/95	5069.87	
1.1 4WD / Touring	156C.000 / .046	1108	01/89>12/94	5069.87	
1.3	146A5.046	1297	01/89>10/95	6564.80	 6564
	156B.000	1301	01/89>09/92	6564.80	 6872
BMW					
Série 1 NEW					
116i - 1.6	N45B16	1596	09/04	6958.95	
118 d - 1.9 D	M47D20	1995	09/04>	6872.88	
	M47D20	1995	09/04	6957.00	
118i - 2.0	N46B20UL	1995	09/04>	6873.105	
120 d - 1.9 D	M47D20TU2	1995	09/04>	6872.88	 6873
	M47D20TU2	1995	09/04	6957.00	 6957 NEW
120i - 1.9	N46B20OL	1995	09/04>	6873.105	
Série 3 Compact					
316ti (E36)	M43B16	1596	02/94>04/01	6284.95	
	M43B19-E46 / G	1895	01/99>04/01	6495.105	
316ti (E46)	N42B18VVT	1796	04/01>	6873.105	
318d / td (E46)	M47D20TUUL	1995	04/01>	6872.88	
318tds (E36)	M41D	1665	07/95>04/01	5973.80	 6958 NEW



LISTE D'APPLICATIONS

























APPLICATION LIST/ANWENDUNGSLISTE

VEHICULE MODEL FAHRZEUGTYP	MOTEUR ENGINE MOTOR	CYLINDRÉE ENGINE SIZE HUBRAUM	ANNÉE YEAR JAHR	VERNET	PHOTOS PICTURES ZEICHUNGEN
...Série 3 Compact					
318ii (E36) 16V	M42B18	1796	09/94>02/98	6242.92	
	M44B19	1895	01/96>04/01	6498.95	
318ii (E46)	N42B20VVT	1995	04/01>	6873.105	
320d / td (E46)	M47D20TUUL	1995	04/01>	6872.88	
323ii (E36)	M52B25 / EU3	2494	08/97>04/01	6242.92	
	M52B25-EU3	2494	01/99>04/01	6243.92	
323ii (E46)	M54B25	2494	05/01>	6499.97	
Série 3					
316 (E21)	1600	1573	06/75>09/80	3310.80	
	M10B16V	1573	04/81>12/83	3310.80	
316i (E21)	BMW03	1573	09/77>09/81	3310.80	
316i (E30)	M10B18LE	1766	10/84>08/88	3310.80	
	M40B16ME.8	1596	09/88>09/93	5111.88	
	M40B19-E46G	1895	09/98>02/05	6495.105	
	N42B18	1796	01/03>08/05	6873.105	
316i (E36)	M40B16ME.8	1596	12/92>09/93	6243.92	
	M43B16	1596	02/94>04/01	6284.95	
316i (E46)	M43B16-EU2	1596	01/99>04/01	6495.105	
	N42B18VVT	1796	04/01>	6873.105	
316ii (E46)	N42B18VVT	1796	05/01>09/01	6958.95	
318 (E21 / E30)	M10B18V	1766	08/79>09/88	3310.80	
318 (E21)	118/4	1766	06/75>08/79	3310.80	
318 Ci (46)	M43B20	1995	07/99>12/02	6495.105	
318 Ci (E46)	N42B20	1995	01/03>08/05	6873.105	
318 Ci (E46) / 318i (E46) / 318ii (E46)	N42B20VVT	1995	09/01>12/01	6958.95	
318i (E30)	M10B18	1766	09/79>12/83	3310.80	
	M10B18	1766	09/82>08/88	5111.88	
	M40B18	1796	09/87>12/91	5111.88	
318i (E30) 16V	M42B18	1796	11/89>02/02	5111.88	
318i (E36 / E46)	M43B19-E46 / G	1895	03/98>	6495.105	
318i (E36)	M40B18	1796	09/88>09/93	6243.92	
	M43B18	1796	10/93>02/00	6284.95	
318i (E36) 16V	M42B18	1796	09/94>02/98	6243.92	
	M44B19	1895	12/95>02/00	6498.95	
318i (E46)	N42B18VVT	1995	12/01>	6873.105	
318i (E90 / E91)	N46B20UL	1995	09/05>	6873.105	
318d (E46)	M47D20	1995	09/05>	6872.88	
	M47D20TUUL	1995	02/02>08/05	6957.00	
	M47D20UL	1951	09/01>08/05	6494.85	
318tds (E36)	M41D	1665	09/94>09/99	5973.80	
318ii (E46)	N42B20VVT	1995	12/01>	6873.105	
320 Cd (E46) / 320d (E46)	M47D20TU	1995	03/03>	6957.00	
320d (E46)	M47D20UL / EU3	1951	07/99>09/01	6494.85	
320d / td (E46)	M47D20TU	1995	03/98>09/01	6872.88	
320td (E46)	M47D20	1951	03/98>09/01	6494.85	
320 (E21)	E21	1990	07/75>07/79	3310.80	
	M60	1990	08/77>10/82	1535.80	
320i (E21)	2000E	1990	10/75>07/78	3310.80	
320i (E30)	M20B20	1990	09/85>09/93	1535.80	
	M20B20 / K	1990	09/86>05/91	5111.80	
320i (E36) 24V	M50B20	1991	09/92>07/95	5111.80	
	M50B20	1991	12/90>06/95	6243.92	
	M52B20	1991	06/94>02/00	5111.88	
	M52B20	1991	06/94>02/98	6243.92	
					NEW



LISTE D'APPLICATIONS















APPLICATION LIST/ANWENDUNGSLISTE

VEHICULE MODEL FAHRZEUGTYP	MOTEUR ENGINE MOTOR	CYLINDRÉE ENGINE SIZE HUBRAUM	ANNÉE YEAR JAHR	VERNET	PHOTOS PICTURES ZEICHUNGEN
...Série 3					
320i (E46)	M43B20	1995	09/01>	6495.105	 1535
	M52B20-EU3	1991	03/98>09/01	6499.97	
	M54B22	2171	09/01>08/05	6499.97	
	M54B22-EU3	2171	07/00>12/02	6499.97	
320i (E90 / E91)	N46B20OL	1995	03/05>	6873.105	 3310
323i (E21)	M60.EZ	2316	01/78>10/82	1535.80	 5111
323i (E30)	M20B23L	2316	09/82>09/85	1535.80	
	M20B23L	2316	09/85>09/86	5111.80	 5973
323i (E36)	M52B25	2494	03/98>12/00	6243.92	 6242
	M52B25	2494	03/95>02/00	5111.88	
323i (E46)	M52B25-EU3	2494	03/99>08/05	6499.97	 6243
324d (E30)	M21D24W	2443	09/85>12/91	1535.92	
324td (E30)	M21D24WA	2443	09/87>09/93	1535.80	 6284
	M20B27ME	2693	02/85>09/85	1535.80	
325e (E30)	M20B27ME	2693	09/85>08/87	5111.80	 6492
	M20B25M / G	2494	02/88>09/93	5111.80	
325i (E30)	M20B25M1.Z7	2494	09/86>12/92	5111.80	 6494
	M20B27M1.Z7	2692	02/85>09/85	1535.80	
	M20B27M1.Z7	2692	10/85>08/87	5111.80	
	M20B27M1.Z7	2692	10/85>08/87	5111.80	
325i (E36)	M52B25 / EU3	2494	08/97>	6242.92	 6495
325i (E36) 24V	M50B25	2494	12/90>07/95	5111.88	
	M50B25	2494	12/90>08/95	6243.92	
325i (E46)	M52B25-EU3	2494	03/98>12/00	6499.97	 6872
	M54B25 / EU3 / EU4	2494	07/00>	6499.97	
325td (E36)	M51A	2497	08/91>02/98	5973.80	 6873
	M51D25	2497	12/92>09/99	5973.80	
328i (E36) 24V	M52B28	2793	01/95>02/00	5111.88	 6872
	M52B28	2793	01/95>02/98	6243.92	
328i (E46)	M52B28-EU3	2793	03/98>12/00	6499.97	 6872
330 Cd (E46) / 330d (E46) / 330xd (E46)	M57D30TU	2993	03/03>	6957.00	 6872
330d (E46) / 330xd (E46)	M57D30-204	2993	03/03>02/05	6957.00	
330d (E90 / E91) / 330xd (E90 / E91)	M57D30TU2	2993	09/05>	6957.00	 6872
330d / td	M57D30	2926	09/99>02/03	6492.88	
330d / xd (E46)	M57D30TU	2993	03/03>02/05	6872.88	 6872
330i (E46)	M54B30-231	2979	08/00>12/01	6499.97	
330xd	M57D30	2926	03/03>08/05	6492.88	 6872
Série 5					
518 (E12)	118/4	1766	09/74>09/80	3310.80	 6872
518i (E12)	M10B18K / V	1766	09/79>06/81	3310.80	
518i (E28)	M10B18LE / V	1766	04/81>09/84	3310.80	 6872
518i (E34)	M40B18	1796	09/89>04/94	5111.88	
	M43B18	1796	05/94>09/96	6284.95	
520 (E12)	M17	1990	06/72>01/79	3310.80	 6872
	M60	1990	08/77>06/81	1535.80	
520d (E39)	M47D20	1951	01/00>04/03	6494.85	 6872
	M47D20-EU3	1951	01/00>	6494.85	
	M47D20TU2	1995	09/05>	6872.88	
520i (E12)	M15E12	1990	10/72>07/78	3310.80	 6872
520i (E28)	M20B20K	1990	04/81>09/85	1535.80	
	M20B20K	1990	10/85>08/88	5111.80	
	M20B20M1.Z7	1990	09/86>07/90	5111.80	
520i (E34)	M20B20M0.E8	1990	02/88>04/90	5111.80	 6872
	M50B20	1991	10/91>09/96	5111.88	



LISTE D'APPLICATIONS























APPLICATION LIST/ANWENDUNGSLISTE

VEHICULE MODEL FAHRZEUGTYP	MOTEUR ENGINE MOTOR	CYLINDRÉE ENGINE SIZE HUBRAUM	ANNÉE YEAR JAHR	VERNET	PHOTOS PICTURES ZEICHNUNGEN
...Série 5					
520i (E34) 24V	M50B20	1991	02/90>09/92	5111.80	 1528
	M50B20	1991	03/90>09/95	6243.92	
520i (E39 / E60)	M54B22	2171	07/00>03/05	6499.97	 1535
520i (E39)	M52B20	1991	09/98>04/04	6243.92	
	M52B20-EU3	1991	07/99>04/04	6494.85	
	M52B20-EU3	1991	07/99>04/04	6499.97	
	M54B22	2171	07/00>03/05	6494.85	
523i (E39)	M52B25	2494	09/95>09/98	6243.92	 5111
	M52B25-EU3	2494	07/99>04/04	6494.85	
	M52B25-EU3	2494	07/99>04/04	6499.97	
523i (E60 / E61)	N52B25UL	2497	03/05>	6984.00	 5973
524d (E28)	M21D24W	2443	05/86>08/88	1535.92	 6243
524td (E28 / E34)	M21D24WA	2443	11/82>08/91	1535.80	
525 (E12)	M125	2494	10/73>06/81	1528.80	 6492
525d (E46)	M57D25	2497	01/00>04/04	6492.88	
525d (E60 / E61)	M57D25TU	2497	05/03>	6957.00	 6494
525e (E28)	M20B27ME	2693	03/83>09/85	1535.80	
	M20B27ME	2693	10/85>08/88	5111.80	
525i (E39)	M54B25	2494	07/00>04/04	6494.85	 6497
	M54B25-EU4	2494	09/03>02/05	6499.97	
525i (E28)	M30B25 / L	2494	10/85>08/88	5111.80	 6499
	M30B25L	2494	05/81>09/85	1528.80	
525i (E34)	M20B25	2494	02/88>09/92	5111.80	 6872
525i (E34) 24V	M50B25	2494	03/90>09/96	5111.88	
	M50B25	2494	03/90>09/96	6243.92	
525i (E60 / E61) / 525xi (E60 / E61)	N52B25OL	2497	03/05>	6984.00	 6941
525td (E34 / E39)	M51D25	2497	10/95>04/04	5973.80	
525td (E34)	M51A	2497	02/93>09/96	5973.80	 6957
525td (E45)	M57D25TU	2497	05/03>	6872.88	
528 (E12)	E3	2788	01/75>07/77	1528.80	 6984
528i (E12 / E28)	M30B28L / LE	2788	03/77>09/85	1528.80	
528i (E28)	M30B28LE	2788	10/85>08/88	5111.80	 6957 NEW
528i (E39)	M52B28	2793	09/98>04/04	6243.92	
	M52B28-EU3	2793	07/99>04/04	6494.85	
530d (E39)	M52B28-EU3	2793	07/99>04/04	6499.97	
	M57D30-183	2926	09/98>09/00	6941.88	
530d (E46)	M57D30-193	2926	09/00>04/04	6492.88	
	M57D30	2926	09/98>	6492.88	
530d (E60 / E61) / 535d (E60 / E61)	M57D30TU	2993	05/03>	6957.00	
530d / td (E46)	M57D30TU	2993	09/05>	6872.88	
530i (E34)	M30B30M.E7	2986	01/88>06/90	5111.80	
530i (E34) V8 32V	M60B30	2997	09/92>09/96	6497.85	
	M60B30	2997	09/92>09/96	6497.95	
530i (E39 / E60)	M54B30-231	2997	07/00>02/05	6499.97	
530i (E39)	M54B30-231	2997	07/00>02/05	6494.85	
530i (E60 / E61) / 530xi (E60 / E61)	N52B30B	2996	03/05>	6984.00	
535i (E28 / E34)	M30B34M / ME	3430	09/85>04/93	5111.80	
535i (E28)	M30B34M / ME	3430	02/85>09/85	1528.80	
535i (E34)	M30B35M7	3430	01/88>04/93	5111.80	



LISTE D'APPLICATIONS

APPLICATION LIST/ANWENDUNGSLISTE

VEHICULE MODEL FAHRZEUGTYP	MOTEUR ENGINE MOTOR	CYLINDRÉE ENGINE SIZE HUBRAUM	ANNÉE YEAR JAHR	VERNET	PHOTOS PICTURES ZEICHNUNGEN
...Série 5					
535i (E39)	M62B35	3498	07/96>03/04	6493.105	 1528
	M62B35	3498	09/98>03/04	6496.105	
	M62B35-245	3498	07/99>04/03	6493.105	 5111
540i (E34) V8	M60B40	3982	09/92>09/96	6497.85	 5973
	M60B40	3982	09/92>09/96	6497.95	
540i (E39)	M62B44	4398	07/96>09/98	6496.105	 6492
	M62B44-285	4398	09/98>04/04	6493.105	
M5 3.5i (E12)	M30B35L	3453	04/80>05/81	1528.80	 6493
M5 3.5i (E28)	M30B34M	3430	12/84>09/85	1528.80	
	M30B34M	3430	09/85>08/88	5111.80	
	M30B35M.E7	3430	02/85>09/85	1528.80	
	M30B35M.E7	3430	09/85>08/88	5111.80	
M88 / 3	3453	10/84>08/88	1528.80	 6494	
M5 3.6i (E34)	S38B36	3535	07/88>12/91	CT16958.76	 6496
M5 3.8i (E34)	S38B38	3795	12/91>	CT16958.76	
M5 5.0i (E39)	S62B50	4941	07/99>	CT16958.76	
Série 6					
628i (E24)	M30B28LE	2788	09/79>09/85	1528.80	 6497
	M30B28LE	2788	09/85>08/88	5111.80	
630i (E24)	M30B30M	2986	02/76>08/79	1528.80	 6499
	M30B32L	3210	01/76>12/81	1528.80	
635i (E24)	M30B34M	3430	05/82>09/85	1528.80	 6872
	M30B34M	3430	09/85>04/89	5111.80	
	M30B35L	3453	06/78>08/82	1528.80	
	M30B35M.E7	3430	01/85>09/85	1528.80	
	M30B35M.E7	3430	09/85>04/89	5111.80	
M635i (E24)	M88 / 3	3453	04/84>04/89	1528.80	 6941
M635i (E24)	M30B35M.E7	3430	01/86>04/89	1528.80	
Série 7					
725i (E23)	M30B25L	2494	09/81>09/85	1528.80	 6957
	M30B25L	2494	10/85>04/86	5111.80	
725td (E38)	M51D25	2497	04/96>08/01	5973.80	 6957 NEW
728 (E23)	M128	2788	04/77>08/79	1528.80	
728i (E23)	M30B28LE	2788	09/77>09/85	1528.80	 6957 NEW
	M30B28LE	2788	09/85>04/86	5111.80	
728i (E38)	M52B28-EU3	2793	07/98>08/01	6494.85	 6957 NEW
730 (E23)	M30B30	2986	07/77>08/79	1528.80	
730d	M57D30	2926	09/98>08/01	6492.88	 6957 NEW
	M57D30	2926	09/98>08/01	6941.88	
730d (E65)	M57D30TU / M57D30TU2	2993	09/02>	6957.00	 6957 NEW
	M57D30TU2	2993	03/05>	6872.88	
	M57D30TU	2993	09/02>02/05	6872.88	
730d / td (E46)	M57D30TU	2993	09/02>02/05	6872.88	 6957 NEW
730i (E32)	M30B30M / E7	2986	09/86>03/94	5111.80	
730i (E32) V8	M60B30	2997	04/92>05/94	6497.85	 6957 NEW
730i (E38) V8	M60B30	2997	06/94>08/01	6497.95	
730i (E65)	M54B30	2979	09/03>02/05	6499.97	 6957 NEW
730Li (E66)	N52B30B	2996	03/05>	6872.88	
732i (E23)	N52B30B	2996	03/05>	6957.00	 6957 NEW
	M30B32L / LA	3210	03/77>04/83	1528.80	
732i (E23) / 733i	M30B32M	3210	09/85>04/86	5111.80	 6957 NEW
	M30B32M	3210	06/77>09/85	1528.80	
733i (E23)	M30B32L / LA	3210	03/77>04/83	1528.80	 CT16958



LISTE D'APPLICATIONS

APPLICATION LIST/ANWENDUNGSLISTE

VEHICULE MODEL FAHRZEUGTYP	MOTEUR ENGINE MOTOR	CYLINDRÉE ENGINE SIZE HUBRAUM	ANNÉE YEAR JAHR	VERNET
...Série 7				
735i (E23)	M30B34M	3430	09/82>09/85	1528.80
	M30B34M	3430	09/85>12/88	5111.80
	M30B35L	3453	09/79>09/82	1528.80
	M30B35M.E7	3430	10/84>09/85	1528.80
	M30B35M.E7	3430	09/85>07/92	5111.80
735i (E23) Turbo / 745i	M30B34MA	3430	01/83>09/85	1528.80
	M30B34MA	3430	09/85>04/86	5111.80
735i (E32)	M30B35	3430	09/86>11/88	5111.80
735i (E38) V8	M62B35	3498	04/96>08/01	6493.105
740i (E32) V8	M60B40	3982	09/92>05/94	6497.85
740i (E38) V8	M60B40	3982	06/94>03/96	6497.95
	M62B44	4398	04/96>08/01	6493.105
	M62B44	4398	04/96>08/01	6493.105
745i (E23)	M30B32L / LA	3210	03/77>04/83	1528.80
745i (E23) Turbo	M30B34MA	3430	09/85>04/86	5111.80
750i (E32)	M70B50	4988	11/86>05/94	6497.85
Série 8				
840 (E31)	M60B40	3982	12/92>07/96	6497.85
	M62B44	4398	03/96>12/00	6497.85
840 (E31) Tropical Version	M60B40	3982	12/92>07/96	6497.70
850 (E31)	S70B56	5576	09/92>07/96	6497.85
850 (E31) Tropical Version	S70B56	5576	09/92>07/96	6497.70
850 (E31) VIN EG21	M70B50	4988	09/89>08/94	6497.70
850 (E31) VIN EG22	M70B50	4988	09/89>08/94	6497.85
X3				
2.0	N46B20OL	1995	09/05>	6873.105
2.0 D	M47D20TU	1995	09/04>	6872.88
	M47D20TU	1995	09/04>	6957.00
2.5i	M54B25-EU4	2494	03/04>	6499.97
3.0 D	M57D30 / M57D30TU	2993	10/03>	6957.00
	M57D30-204	2993	10/03>09/05	6872.88
3.0 D / 3.0 TD	M57D30TU	2993	09/05>	6872.88
3.0i	M54B30-231	2979	10/03>	6499.97
X5				
3.0	M54D30	2629	08/03>	6492.88
3.0 d	M57D30	2926	03/01>08/03	6492.88
3.0 d / td	M57D30TU	2993	08/03>	6872.88
3.0i	M54B30-231	2979	01/00>	6499.97
4.4i	M62B44	4398	01/00>08/03	6493.105
4.6is	M62B46	4619	09/01>	6493.105
Z1				
2.5i	M20B25M1.Z7	2494	03/89>12/92	5111.80
Z3				
1.8i	M43B18	1796	01/96>08/98	6284.95
	M43B19-EU3	1895	09/98>	6495.105
	M44B19	1895	01/96>04/99	6498.95
2.0i	M52B20-EU3	1991	04/99>	6499.97
2.2	M54B22	2171	08/00>	6499.97
2.2i	M54B22-EU3	2171	08/00>	6499.97
2.8i	M52B28	2793	03/96>09/98	6243.92
	M52B28	2793	09/98>	6499.97
3.0i	M54B30-231	2979	06/00>	6499.97
Z4				
2.0	N46B20OL	1995	03/05>	6873.105
2.2i	M54B22	2171	03/04>	6499.97





LISTE D'APPLICATIONS

APPLICATION LIST/ANWENDUNGSLISTE

Thermostats

Chrysler

VEHICULE MODEL FAHRZEUGTYP	MOTEUR ENGINE MOTOR	CYLINDRÉE ENGINE SIZE HUBRAUM	ANNÉE YEAR JAHR	VERNET
Neon				
2.0 16V	ECB	1996	01/93>12/98	1477.87
	ECB / ECC	1996	10/93>12/98	6843.91
New Yorker				
3.5 V6	EGE	3523	04/92>01/93	1477.87
PT Cruiser				
1.6	EJD	1598	11/01>	6843.91
2.0 16V	ECC	1996	09/00>	6843.91
2.2 CRD	EDJ	2148	02/02>	6961.87
2.4 16V	EDZ	2429	06/00>	6843.91
Sebring				
2.0 16V	ECC	1996	03/00>	6843.91
2.7 V6 24V	EES	2736	03/00>	6845.88
Stratus				
2.0	ECB	1996	01/94>	6843.91
2.4	EDZ	2429	01/94>	6843.91
2.5 V6	EEB	2497	01/94>	6297.82
Vision				
3.5 V6	EGE	3523	10/92>	1477.87
Voyager				
2.4	EDZ	2429	03/01>	6843.91
2.5	EDM	2501	03/83>10/95	1477.87
2.5 CRD	ENC	2500	03/01>	6843.91
	ENC	2500	03/01>	6956.00
2.5 TD	MOU	2499	01/93>10/95	6570.80
	MOU	2499	01/93>10/95	5963.80
2.5i	EDM	2501	03/91>10/95	1477.87
2.8 CRD		2799	09/05>	6956.00
3.0	EFA	2972	03/89>02/91	1477.87
3.3	EGA	3301	03/01>12/03	5963.80
3.3 V6	EGA	3301	04/92>10/95	6843.91
3.3i / 4WD	EGA	3301	04/92>10/95	1477.87
Grand Voyager				
2.5 TD	MOU	2499	01/93>10/95	6570.80
	MOU	2499	01/93>10/95	5963.80
2.8 CRD		2799	09/05>	6956.00
3.3	EGA	3301	03/01>	6956.00
3.3i / 4WD	EGA	3301	04/92>10/95	1477.87

CITROEN

AX				
1.0	TU9	954	09/86>04/91	6148.89
1.1	TU1	1124	05/91>07/96	6148.89
1.3	TU2	1294	04/87>04/91	6148.89
	TU24	1294	04/87>04/91	6148.89
1.4	TU3	1360	09/86>12/88	6148.89
1.4 D	TUD3	1360	09/88>07/94	1542.89
1.5 D	TUD3	1527	07/94>07/96	1542.89
	TUD5	1527	07/94>07/96	1542.89
BX				
1.1	XW7	1124	09/82>04/88	5108.83
	XW7 / TU1	1124	04/88>12/91	6148.89
1.4	TU3	1360	12/86>12/94	6148.89
	TU3	1360	07/88>12/94	5108.83
	XY6 / XY7	1360	02/86>11/89	6148.89
	XY6	1360	09/82>04/88	5108.83



1477



1542



5108



5963



6148



6297



6570



6843



6845



6956

NEW

















6961

NEW

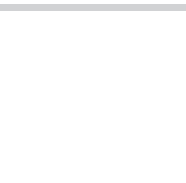

LISTE D'APPLICATIONS

APPLICATION LIST/ANWENDUNGSLISTE

VEHICULE MODEL FAHRZEUGTYP	MOTEUR ENGINE MOTOR	CYLINDRÉE ENGINE SIZE HUBRAUM	ANNÉE YEAR JAHR	VERNET	PHOTOS PICTURES ZEICHNUNGEN
CX					
2.0	829	1995	07/79>07/82	0963.86	
	J6R	1995	07/82>12/89	0963.86	
	M20	1985	07/74>06/79	0963.86	
2.2	J6T	2165	07/85>07/91	0963.86	
	M22	2165	02/75>07/76	0963.86	
2.2 D	M22	2165	11/75>04/78	1275.78	
	M22	2165	05/78>06/79	0963.86	
2.3	M23	2347	01/76>07/83	0963.86	
2.5	M25	2500	07/83>07/89	0963.86	
2.5 D	M25	2500	02/79>07/91	0963.86	
Evasion					
1.8	XU7	1761	07/96>05/02	5108.83	
1.9 TD	XUD9	1905	10/94>05/02	5130.83	
2.0	DW10	1997	08/99>05/02	5130.83	
	EW10	1997	07/00>05/02	6488.89	
	XU10	1998	07/94>07/96	5108.89	
	XU10	1998	08/96>05/02	5108.83	
2.0 16V	XU10	1998	10/98>05/02	4885.83	
2.1 TD	XUD11	2088	04/96>05/02	5130.83	
LNA					
1.0	XV8	954	01/84>07/86	5108.83	
1.1	XW7	1124	07/82>07/86	5108.83	
Saxo					
1.0	TU9	954	03/96>	6148.89	
1.1	TU1	1124	03/96>	6148.89	
	TU1	1124	09/00>	6191.89	
1.4	TU3	1360	03/96>	6148.89	
	TU3	1360	05/98>11/98	6106.89	
	TU3	1360	11/98>08/99	6191.89	
1.5 D	TUD5	1527	05/96>	1542.89	
1.6	TU5	1587	03/96>	6148.89	
	TU5	1587	09/99>	6191.89	
Visa					
1.0	XV8	954	11/83>07/87	5108.83	
1.1	XM7	1124	07/83>06/88	5108.83	
	XW7	1124	10/78>07/88	5108.83	
1.2	129	1219	07/80>07/83	5108.83	
1.4	150	1360	07/84>07/87	5108.83	
	156	1360	03/81>07/87	5108.83	
	XY7	1360	07/84>07/88	5108.83	
	XY8	1360	03/82>09/86	5108.83	
1.6	XU5	1580	10/84>07/88	5108.83	
1.8 D	XUD7	1769	03/84>07/88	4947.81	
Xantia					
1.6	XU5	1580	08/93>07/96	5108.89	
	XU5	1580	07/96>12/97	5108.83	
1.8	XU7	1761	09/93>12/97	5108.89	
	XU7	1761	03/93>07/96	5108.83	
1.8 16V	XU7	1761	07/95>05/02	4885.83	
1.9 D	XUD9	1905	06/93>12/97	5130.83	
1.9 SD	XUD9	1905	09/96>12/97	5130.83	
	XUD9	1905	12/97>05/02	4885.83	
1.9 TD	XUD9	1905	06/93>05/02	4885.83	



LISTE D'APPLICATIONS

APPLICATION LIST/ANWENDUNGSLISTE

VEHICULE MODEL FAHRZEUGTYP	MOTEUR ENGINE MOTOR	CYLINDRÉE ENGINE SIZE HUBRAUM	ANNÉE YEAR JAHR	VERNET	PHOTOS PICTURES ZEICHNUNGEN
...Xantia					
2.0	XU10	1998	03/93>06/95	5108.89	
	XU10	1998	09/93>05/02	5108.83	
2.0 16V	XU10	1998	03/93>12/97	4885.89	1542
	XU10	1998	07/95>05/02	4885.83	4640
2.0 HDi	DW10	1997	10/98>05/02	5130.83	
3.0 V6 24V	ES9	2946	11/96>05/02	CT1743.82	
XM					
2.0	XU10	1998	05/89>06/94	5108.89	
	XU10	1998	01/90>07/01	5108.83	4780
2.0 16V	XU10	1998	07/94>07/01	4885.83	
2.1 D	XUD11	2138	09/89>12/90	4640.85	5108
2.5 D / TD	DJ5 / DK5	2446	02/94>	5313.85	
2.5 TD	DJ5 / DK5	2446	07/94>07/01	5413.84	5130
3.0 V6	ZPJ	2975	05/89>06/94	4780.78	
3.0 V6 24V	ZPJ	2963	07/90>06/97	4780.78	
Xsara					
1.1	TU3JP	1360	11/98>08/00	6191.89	
1.4	TU3	1360	07/97>08/00	6148.89	
	TU3	1360	09/00>	6488.89	6106
	TU3JP	1360	07/97>11/98	6106.89	6148
1.4 HDi	DV4TD / L4	1398	01/03>	6874.83	
1.5 D	TUD5	1527	03/98>08/00	1542.89	
1.6	TU5	1587	07/97>08/00	6148.89	6191
1.6 16V	TU5	1587	09/00>	6488.89	
1.8	XU7	1761	07/97>08/00	5108.83	
1.8 16V	XU7	1761	07/97>08/00	4885.83	
1.8 D	XUD7	1769	03/98>08/00	5130.83	6874
1.9 D	DW8	1868	09/98>	5130.83	
	XUD9	1905	07/97>08/00	5130.83	
1.9 SD	XUD9	1905	03/98>08/00	5130.83	
1.9 TD	XUD9	1905	07/97>08/00	4885.83	



LISTE D'APPLICATIONS

APPLICATION LIST/ANWENDUNGSLISTE

VEHICULE MODEL FAHRZEUGTYP	MOTEUR ENGINE MOTOR	CYLINDRÉE ENGINE SIZE HUBRAUM	ANNÉE YEAR JAHR	VERNET
...Xsara				
2.0 16V	EW10	1997	09/00>	6332.89
	XU10	1998	01/98>	4885.83
2.0 HDi	DW10	1997	03/99>	5130.83
Xsara Picasso				
1.6	TU5	1587	12/99>	6488.89
1.6 HDi	DV6TED4	1560	03/04>	6875.83
1.8 16V	EW7	1749	12/99>	6332.89
2.0	EW10	1997	01/03>	6332.89
2.0 HDi	DW10	1997	12/99>	5130.83
ZX				
1.1	TU1	1124	03/91>07/98	6148.89
1.4	TU3	1360	03/91>07/98	6148.89
1.4 D	TUD3	1360	07/94>07/98	1542.89
1.5 D	TUD5	1527	07/94>07/98	1542.89
1.6	XU5	1580	03/91>07/96	5108.89
	XU5	1580	09/92>07/98	5108.83
1.8	XU7	1761	09/92>07/96	5108.89
	XU7	1761	09/92>07/98	5108.83
1.8 16V	XU7	1761	03/97>07/98	4885.83
1.8 D	XUD7	1769	09/92>07/98	5130.83
1.9	XU9	1905	03/91>08/92	5108.89
	XU9	1905	09/92>08/93	5108.83
1.9 D / TD	XUD9	1905	09/92>07/98	5130.83
2.0	XU10	1998	09/92>07/98	5108.83
	XU10	1998	09/92>07/96	5108.89
2.0 16V	XU10	1998	10/92>07/98	4885.89
	XU10	1998	07/95>07/98	4885.83

CITROËN



Berlingo				
1.1	TU1	1124	07/96>12/02	6148.89
	TU1	1124	01/01>12/02	6191.89
	TU1	1224	12/02>	6488.89
1.4	TU3	1360	07/96>12/02	6148.89
	TU3	1360	05/98>11/98	6106.89
	TU3	1360	05/99>12/02	6191.89
	TU3	1360	12/02>	6488.89
1.6	TU5	1587	12/02>	6488.89
1.6 16V	TU5	1587	12/00>12/02	6191.89
1.6 HDi	DV6	1560	01/06>	6875.83
1.8	XU7	1761	07/97>12/02	5108.83
1.8 D	XUD7	1769	07/96>12/02	5130.83
1.9 D	DW8	1868	07/98>	5130.83
	XUD9	1905	07/96>12/02	5130.83
2.0 HDi	DW10	1997	10/99>	5130.83
C15				
1.0	XV8	954	11/86>05/88	5108.83
	XV8 / TU9	954	05/88>06/95	6148.89
1.1	E1A	1118	07/87>07/88	1529.89
	TU1	1124	07/88>02/01	6148.89
	XW7	1124	10/84>05/88	5108.83
1.3	G1A	1294	07/87>07/88	1529.89



1529



1542



4885



5108



5130



6106



6148



6191



6332



6488



6875



LISTE D'APPLICATIONS

APPLICATION LIST/ANWENDUNGSLISTE

VEHICULE MODEL FAHRZEUGTYP	MOTEUR ENGINE MOTOR	CYLINDRÉE ENGINE SIZE HUBBRAUM	ANNÉE YEAR JAHR	VERNET	PHOTOS PICTURES ZEICHNUNGEN
...C15					
1.4	TU3	1360	07/88>02/01	6148.89	
	XY7	1360	07/86>05/88	5108.83	
	XY7	1360	05/88>07/89	6148.89	
1.7 D	XUD7	1769	10/84>11/91	4947.81	
	XUD7	1769	08/89>05/92	5231.83	
	XUD7	1769	08/89>02/01	5130.83	
1.9 D	DW8B	1868	03/01>	5130.83	
C25					
1.8	XM7	1796	11/81>02/94	2620.82	
1.9 D	XUD9	1905	12/87>02/94	4945.89	
2.0	XN1	1971	11/81>02/94	2620.82	
2.5 D / TD	U25	2500	11/81>02/94	0963.86	
C35					
2.0	B20	1985	11/73>12/91	4046.86	
Dispatch					
1.6	160	1581	09/95>12/03	6541.87	
1.9 D	DW8	1868	02/99>	5130.83	
1.9 D / TD	XUD9	1905	09/95>12/03	5130.83	
2.0 HDi	DW10	1997	09/00>	5130.83	
Jumper					
1.9 D	XUD9	1905	02/94>12/01	5130.83	
1.9 TD	XUD9	1905	02/94>12/01	4885.83	
1.9 TD 4x4	XUD9	1905	07/97>12/01	4885.83	
2.0	DW10	1997	09/01>	5130.83	
	XU10	1998	02/94>	5108.83	
2.0 4x4	XU10	1998	02/94>08/98	5108.83	
2.2	DW12	2179	01/02>	5130.83	
2.2 HDi	DW12	2179	01/02>	5130.83	
2.5 D / TD / TDi	DJ5 / DK5	2446	02/94>12/01	5309.84	
	DJ5 / DK5	2446	02/94>12/01	5313.85	
2.5 D / TDi 4x4	DJ5 / DK5	2446	02/94>12/01	5309.84	
2.5 D 4x4	DJ5 / DK5	2446	02/94>12/01	5313.85	
2.8 D	8140-63	2798	06/99>12/01	6581.82	
2.8 HDi	8140-43S	2798	09/00>12/01	6581.82	
	F28	2798	01/02>	6581.82	
Jumpy					
1.6	160	1581	09/95>12/03	6541.87	
1.9 D	DW8	1868	05/98>	5130.83	
1.9 D / TD	XUD9	1905	09/95>12/03	5130.83	
2.0	EW10	1997	09/00>	6488.89	
2.0 HDi	DW10	1997	09/00>	5130.83	
Relay					
1.9 D	XUD9	1905	02/94>08/98	5130.83	
1.9 TD	XUD9	1905	02/94>12/01	4885.83	
2.0	XU10	1998	02/94>	5108.83	
2.0 HDi	DW10	1997	01/02>	5130.83	
2.2 HDi	DW12	2179	01/02>	5130.83	
2.5 D / TD	DJ5	2446	02/94>08/98	5309.84	
	DJ5	2446	02/94>08/98	5313.85	
2.8 HDi	F28	2798	01/02>	6581.82	
Synergie					
1.8	XU7	1761	07/96>09/98	5108.83	
1.9 TD	XUD9	1905	10/95>05/02	5130.83	



VEHICULE MODEL FAHRZEUGTYP	MOTEUR ENGINE MOTOR	CYLINDRÉE ENGINE SIZE HUBRAUM	ANNÉE YEAR JAHR	VERNET
...Synergie				
2.0	EW10	1997	07/00>05/02	6488.89
	XU10	1998	10/95>07/96	5108.89
	XU10	1998	07/96>05/02	5108.83
2.0 HDi	DW10	1997	08/99>05/02	5130.83
DACIA				
Logan NEW				
1.4 MPI	K7J	1390	09/04>	6047.89
1.5 DCi	K9K	1461	09/04>	6666.89
1.6 MPI	K7M	1598	09/04>	6047.89
Solenza NEW				
1.4	EJ7.262	1390	04/03>	5284.91
1300				
1.3	810	1289	01/69>12/85	4495.89
1310				
1.3	810	1289	12/85>	4495.89
SuperNova				
1.4	E7J.260MA / B / D	1390	07/00>	5284.91
DAIHATSU				
Applause				
1.6	HD-C / HD-E	1589	06/89>05/90	6484.82
1.6 / 4WD	HD-C / HD-E	1589	09/97>	6275.78
	HD-C / HD-E	1589	06/90>	6275.84
Charade				
1.0	CB / CB80	993	01/78>01/87	3328.88
	CB23 / CB50 /			
	CB61 / CB90	993	02/87>10/95	3328.88
	CB80	993	02/87>01/93	6310.88
1.0 D	CL11 / CL60	993	01/83>12/86	5077.88
1.0 TD	CL / CL61	993	02/85>01/93	5077.88
1.3	HC-E	1295	03/93>	6275.84
	HC-U	1296	09/97>	6275.78
	HC-U	1296	09/97>	6275.84
1.3 / 4WD	HC-C / HC-E	1295	09/88>	6275.84
1.5	HE-EG	1499	06/94>	6275.78
	HE-EG	1499	06/94>	6275.84
1.6	HD-E	1589	02/82>04/93	6484.82
	HD-E	1589	03/93>05/96	6275.78
	HD-E	1589	03/93>05/96	6275.84
Charmant				
1.3	4K-U	1290	12/79>11/81	6484.82
	4K-U	1290	12/81>12/82	5075.82
	4K-U	1290	12/82>07/87	6310.88
1.4	T	1407	11/74>08/79	5075.82
1.6	2T	1588	10/81>12/82	5075.82
	2T	1588	12/82>08/83	6310.88
	4A	1588	08/83>07/87	6484.82
Cuore / Domino				
0.6	AB / AD	659	06/79>08/83	6828.82
	AB / AD	659	12/84>08/85	1248.80
0.8	ED / ED-10	846	08/85>08/94	6828.82
	ED-20	846	08/94>08/98	3328.88





LISTE D'APPLICATIONS

APPLICATION LIST/ANWENDUNGSLISTE

VEHICULE MODEL FAHRZEUGTYP	MOTEUR ENGINE MOTOR	CYLINDRÉE ENGINE SIZE HUBRAUM	ANNÉE YEAR JAHR	VERNET
...Cuore / Domino				
1.0	EJ-VE / EJ-DE	989	10/98>03/03	6267.82
Feroza				
1.6 Wagon	HD-C / HD-E	1589	10/88>12/97	6275.78
	HD-C / HD-E	1589	10/88>12/97	6275.84
Fourtrak				
2.0	3Y	1998	10/85>06/93	6484.82
2.8 D / TD	DL42 / DL51	2765	10/86>	6525.82
Gran Move				
1.5	HE-EG	1499	08/96>06/98	6275.78
	HE-EG	1499	08/96>06/98	6275.84
1.6 16V	HD-EP	1589	09/97>	6275.78
	HD-EP	1589	09/97>	6275.84
Hijet				
1.0	CB / CB41 / CB42	993	07/86>	3328.88
Mira / Move				
0.8	ED-10	847	08/92>08/94	6828.82
	ED-20	847	08/94>03/99	3328.88
1.0	EJ-DE / EJ-VE	989	04/99>	6267.82
Rocky				
2.0 4x4	3Y	1998	04/84>08/91	6484.82
2.8 D 4x4	DL42	2765	04/84>	6525.82
	DL42	2765	04/84>	6525.88
2.8 TD 4x4	DL51	2765	09/84>	6525.82
	DL51	2765	09/84>	6525.88
Sirion				
1.0	EJ-DE / EJ-VE	989	04/98>	6267.82
1.3	K3-VE	1298	05/00>	6876.80
Sportrak				
1.6	HD-C / HD-E	1589	03/89>12/97	6275.78
	HD-C / HD-E	1589	03/89>12/97	6275.84
Taft				
1.6 4WD	12R	1587	09/76>10/81	6310.82
Terios				
1.3	HC-EJ	1296	03/97>05/00	6275.78
	K3-VE	1298	05/00>	6876.80
1.3 4WD	HC-EJ	1296	03/97>05/00	6275.84
Valera				
1.5	HE-EG	1499	08/94>	6275.84
Wildcat				
1.6	HD-E	1589	02/78>04/84	6484.82
2.0	3Y	1998	04/84>01/87	5075.82
	3Y	1998	04/84>01/87	6484.82
2.5 D	5Y	2489	02/79>12/82	5077.88
2.8 D	DL42	2765	02/82>12/85	5075.82
YRV				
1.0	EJ-VE	989	08/00>	6267.82
1.3	K3-VE / VET	1298	08/00>	6876.80
FIAT				
124				
1.2	124A	1197	03/66>08/72	1473.88
	124A	1197	10/72>	3311.80
1.4 / T	124AC / 124B2	1438	10/66>08/72	1473.88
1.6	125BC	1608	10/69>08/72	1473.88

PHOTOS PICTURES ZEICHUNGEN	
 1473	 3311
 3328	 5075
 5077	 6267
 6275	 6310
 6484	 6525
 6828	 6876



LISTE D'APPLICATIONS

APPLICATION LIST/ANWENDUNGSLISTE

VEHICULE MODEL FAHRZEUGTYP	MOTEUR ENGINE MOTOR	CYLINDRÉE ENGINE SIZE HUBRAUM	ANNÉE YEAR JAHR	VERNET
...124				
1.6 / T	125BC / 132AB	1592	09/72>08/75	245F.79
1.8	132C	1756	09/72>08/77	245F.79
125				
0.6	126A / A1	594	10/72>08/77	6708.70
0.7	126A1 / A2	652	09/77>10/96	6708.70
1.6	125A	1608	09/69>10/73	1473.88
	125A / B	1608	10/69>10/73	245F.79
126 NEW				
600	126A	594	10/72>08/77	6708.70
650	126A1	652	09/77>12/87	6708.70
700	126A2	704	09/87>12/96	6708.70
127				
0.9 - 903	100GL / 127GL	903	10/72>12/86	1522.87
	127A / A1	903	03/71>09/72	1473.88
	127GL	903	03/71>09/72	1473.88
1.0 - 1050	127A / 127A1	1049	07/77>12/86	1519.82
	127GL	1049	07/77>	1519.82
1.3 -1300	127A3.000	1301	07/81>12/86	1519.82
1.3 -1300 d	127A5.000	1301	02/81>02/85	1519.82
1.6 D	130	1601	06/83>	5686.80
128				
1.1	128A	1116	07/72>08/81	3905.82
1.3	128A1 / AR	1290	07/72>07/80	3905.82
All models			10/69>06/72	1400.83
130				
All models			07/72>	1400.77
131				
1.3 - 1300	131A / 131B	1297	11/74>02/81	245F.79
1.4 - 1400	131C1	1367	03/81>12/82	245F.79
1.6 - 1600	131A1 / 131B1	1585	11/74>12/85	245F.79
2.0 - 2000	131C4 / 154C3 / C5	1995	09/78>12/85	245F.79
2.0 D	8144-65	1999	03/81>12/83	3309.74
2.5 D	8144-61	2445	09/77>12/85	3309.74
132				
1.6 - 1600	132A / B / C	1592	10/72>08/81	245F.79
1.8 - 1800	132A1 / B1	1756	10/72>03/77	245F.79
2.0 - 2000	132C2 / DB	1995	04/77>08/81	245F.79
2.5 D	8140-61	2445	09/78>08/81	3309.74
900				
0.9 - 900	100GF / 1000GF	903	01/76>10/87	1473.88
Albea				
1.2 16V	188A4 / A5	1242	04/02>	6782.87
1.3 JTD	188A9.000	1248	09/03>	6835.88
1.6 16V	182B6	1596	04/02>	6590.88
Argenta				
1.6 - 1600	132D3	1585	04/81>06/86	245F.79
1.8 - 1800	132C1	1756	04/81>05/83	245F.79
2.0 - 2000	132C3 / D1 / E	1995	04/81>06/86	245F.79
2.5 D / TD	8144-61 / 8144-81	2445	05/83>06/86	3309.74
Barchetta				
1.8	188A6.000	1747	09/00>07/03	6508.88
1.8 16V	183A1	1747	05/95>06/03	6506.88
Bravo / Brava				
1.2	188A2.000	1242	10/98>	6782.87





LISTE D'APPLICATIONS

















APPLICATION LIST/ANWENDUNGSLISTE

VEHICULE MODEL FAHRZEUGTYP	MOTEUR ENGINE MOTOR	CYLINDRÉE ENGINE SIZE HUBRAUM	ANNÉE YEAR JAHR	VERNET	PHOTOS PICTURES ZEICHUNGEN
...Bravo / Brava					
1.2 16V	182A5 / 182B2	1242	10/98>	6782.87	 5687  6489
1.4 (A/C) / 12V	182A3 / 182A5	1372	06/95>09/98	6508.88	 6504  6508
1.4 / 12V	182A3 / 182A5	1372	06/95>09/98	6557.88	 6509  6551
1.6 / 12V / 16V	182A4 / 182A6	1581	06/95>	6504.88	 6553  6557
1.7 D	176B3	1697	10/94>04/97	6553.80	 6562  6590
1.8 / 16V	182A2	1747	06/95>	6509.88	 6782  6826
1.9 D	160A7	1929	06/95>09/98	5687.80	
	160A7	1929	06/95>09/98	6562.82	
1.9 JTD	182B4	1910	10/98>	6551.88	
	182B4	1910	10/98>	6489.88	
	182B9	1910	10/98>	6826.88	



LISTE D'APPLICATIONS

















APPLICATION LIST/ANWENDUNGSLISTE

VEHICULE MODEL FAHRZEUGTYP	MOTEUR ENGINE MOTOR	CYLINDRÉE ENGINE SIZE HUBRAUM	ANNÉE YEAR JAHR	VERNET	PHOTOS PICTURES ZEICHUNGEN
...Bravo / Brava					
1.9 TD - 75	182A7 / 182A8	1910	03/96>	6555.75	 1514
	182A7 / 182A8	1910	03/96>	6878.75	 5069
	182A7 / 182A8	1910	03/96>	6256.75	 6256
	182A7 / 182A8	1910	03/96>	6258.75	 6258
	182A7 / 182A8	1910	06/97>	6258.75	 6256
	182A7 / 182A8	1910	06/97>	6259.75	 6259
2.0 20V	182A1 / 182B7	1998	06/95>	6547.88	 6262
Cinquecento					
0.7 - 700	170A	704	01/92>02/98	6262.87	 6264
	170A	704	01/92>02/98	6731.87	 6265
0.9 - 900	1170A1 / 170A1	899	06/92>02/98	6265.87	 6490
0.9 - 900i	1170A1 / 170A1	899	01/92>02/98	6264.87	 6506
1.1	176B2	1108	10/94>02/98	5069.87	 6547
Coupé					
1.8 16V	183A1	1747	11/93>05/98	6490.83	 6555
	183A1	1747	06/98>	6506.88	 6731
2.0 20V	182A1 / 182B3	1998	07/96>	6547.88	 6839
2.0 20V Turbo	175A3	1998	07/96>	6839.88	 6878
Croma					
2.0 CHT	154A / 154C / 834B	1995	10/85>08/96	1514.81	 6878



LISTE D'APPLICATIONS

APPLICATION LIST/ANWENDUNGSLISTE

VEHICULE MODEL FAHRZEUGTYP	MOTEUR ENGINE MOTOR	CYLINDRÉE ENGINE SIZE HUBRAUM	ANNÉE YEAR JAHR	VERNET	PHOTOS PICTURES ZEICHNUNGEN
...Croma					
2.0 D / TD / TDi / TDiD	154B / 154C6	1929	07/88>12/92	6592.82	 1514
	154D1	1929	11/92>12/96	6561.82	 3309
2.0 Turbo	154A2 / 154C4	1995	10/85>08/96	1514.81	 5700
2.5 D / TD	8144-67 / -91 / -97	2445	10/85>08/96	5700.82	 5966
	8144-91	2445	10/85>06/88	3309.79	
2.5 V6	834G	2492	06/93>	5966.87	 6508
Croma II NEW					
1.8 16V	939A4.000	1799	09/05>	6983.00	 6557
1.9 JTD - 120ch	939A1.000	1899	09/05>	6978.88	
1.9 JTD - 150ch	939A1.000	1899	09/05>	6978.88	 6561
2.2 16V	194A1.000	2199	09/05>	6980.00	 6590
2.4 JTD	939A4.000	2399	09/05>	6882.88	 6592
Idea					
1.2 16S	188A5	1242	02/04>	6782.87	 6782
1.3 JTD 16V	188A9	1351	10/03>	6835.88	 6835
1.4 16V	843A1	1368	10/03>	6782.87	 6877
1.9 JTD 16V	188B2	1910	02/04>	6877.88	
Marea					
1.2 12V / 16V	182B2	1242	02/99>	6782.87	 6882
1.4 12V	182A3	1372	07/96>01/99	6508.88	 6978 NEW
	182A3	1372	07/96>01/99	6557.88	
1.6 16V	182A4	1581	02/99>	6590.88	 6980 NEW
	182A4 / B6 / 185A3	1581	09/96>01/99	6590.88	 6983 NEW



LISTE D'APPLICATIONS

















APPLICATION LIST/ANWENDUNGSLISTE

VEHICULE MODEL FAHRZEUGTYP	MOTEUR ENGINE MOTOR	CYLINDRÉE ENGINE SIZE HUBRAUM	ANNÉE YEAR JAHR	VERNET	PHOTOS PICTURES ZEICHNUNGEN
...Marea					
1.6 16V / 1.6 16V Bi Power	182A4 / B5 / 185A3	1581	09/96>01/99	6504.88	 5069
1.6 16V Bi Power	182A4	1581	11/97>	6547.88	 6258
1.8 16V	182A2	1747	07/96>	6509.88	
1.9 JTD	182B4	1910	02/99>	6551.88	 6259
	182B9 / 186A6	1910	02/99>	6826.88	 6489
1.9 TD	182A7	1910	07/96>01/99	6555.75	
	182A8	1910	07/96>	6258.75	
	182A8	1910	06/97>	6878.75	 6504
	182A8	1910	02/99>	6259.75	 6509
2.0	185A8.000	1998	02/99>	6547.88	
2.0 20V	182A1 / 182B7	1998	07/96>	6547.88	
2.4 JTD	185A6	2387	02/99>	6868.88	 6541
Multipla					
1.6 16V / Bipower 16V / Blupower 16V	182A4 / B6 / 186A3 / A4	1581	11/98>	6590.88	 6547
1.9 JTD	182B4	1910	10/98>	6489.88	 6551
	182B4	1910	11/98>	6551.88	 6555
	186A6 / A8	1910	11/98>	6826.88	
Palio					
1.1	178B9	1108	09/98>02/01	5069.87	 6590
1.2	178B5 / B7 / C4 / 188A4	1242	09/97>	5069.87	 6782
1.2 / 16V	188A4 / 188A5	1242	03/01>	6782.87	
1.4	178B2	1372	06/99>02/01	6541.87	 6826
1.6	178C8.098	1581	06/99>02/01	6541.87	 6868
1.6 / 16V	178B3 / D2 / 182A4 / B6	1581	06/95>	6504.88	 6878
	178B3 / D2 / E7 / 182A4 / B6	1581	09/97>	6590.88	



LISTE D'APPLICATIONS















APPLICATION LIST/ANWENDUNGSLISTE

VEHICULE MODEL FAHRZEUGTYP	MOTEUR ENGINE MOTOR	CYLINDRÉE ENGINE SIZE HUBRAUM	ANNÉE YEAR JAHR	VERNET	PHOTOS PICTURES ZEICHNUNGEN
...Palio					
1.7 D	176B3	1697	09/97>02/01	6553.80	 1522
	176B3	1697	09/98>02/01	6831.80	 5069
1.7 TD	176A3	1697	09/97>	5976.80	 5686
	176A3	1697	09/97>02/01	6536.80	 5976
	176A3 / 176B7	1697	09/97>02/01	6538.80	
	176B7	1697	07/93>09/99	6539.80	
	178C9.000	1697	09/97>02/01	6539.80	
1.7 TD (A/C)	176A3	1697	03/99>	6538.80	
1.9 D	223A6	1910	09/97>02/01	6832.88	
	223A6	1910	09/97>02/01	6833.88	
1.9 JTD	188A2	1910	03/01>	6869.88	
Panda					
0.6 - 30	126B	652	07/80>02/86	1522.87	 6070
0.8 - 34	100GL6	843	01/82>02/86	1522.87	 6073
0.8 - 750	141B	769	10/89>02/91	6070.87	 6266
	141B / 156A4	769	03/86>12/92	5069.87	 6536
0.9 - 45	100GL3	903	07/80>02/86	1522.87	 6538
0.9 - 750 / 45	100GL3	903	07/80>06/86	6070.87	 6539
0.9 - 900	146A	903	06/89>	6073.85	
	146A	903	04/91>03/92	5069.87	
	146A	903	06/89>02/91	6070.87	
	146A7	903	07/94>	6266.87	
0.9 - 900ie	1170A1	899	10/89>02/91	6070.87	 6553
	1170A1 / 146A	899	04/91>08/03	5069.87	 6564
1.0	156A2 / A3	999	03/86>02/91	5069.87	
1.0 - 1000 4x4	156A3	999	03/86>	5069.87	
	A112B1	965	06/83>02/86	1522.87	
1.0 - 4x4	141C2 / 156A2	999	01/93>08/03	5069.87	 6831
1.1 - 1100 4x4	141C2 / 156C / 176B2	1108	01/93>08/03	5069.87	 6832
1.1 / 4x4 / Van	156C / 176B2 / 187A1	1108	12/02>08/03	5069.87	
1.3 D	156A5	1301	04/86>02/91	5686.80	
	156A5	1301	04/86>	6564.80	
New Panda					
1.1	187A1	1108	09/03>	5069.87	 6833
1.2 / 16V	188A4	1242	09/03>	5069.87	 6869



LISTE D'APPLICATIONS









APPLICATION LIST/ANWENDUNGSLISTE

VEHICULE MODEL FAHRZEUGTYP	MOTEUR ENGINE MOTOR	CYLINDRÉE ENGINE SIZE HUBRAUM	ANNÉE YEAR JAHR	VERNET	PHOTOS PICTURES ZEICHNUNGEN
...New Panda					
1.3 JTD	188A9	1351	09/03>	6835.88	 5069
Punto					
1.1 - 55	176A6	1108	07/93>04/97	6833.88	 5976
1.1 - 55 / Van 55	176A6 / 176B2	1108	07/93>09/99	5069.87	 6506
1.2	188A4	1242	07/99>06/03	5069.87	 6536
1.2 - 60 / 75 / 80 / 85 / Van	176A7 / A8 / B1 / B4 / B9/188A4	1242	07/93>06/03	5069.87	 6538
1.2 16V / 16V 80	188A5	1242	07/99>06/03	6782.87	 6539
1.4 Turbo	176A4 / B6	1372	07/93>09/99	6541.82	 6541
	176A4 / B6	1372	07/93>09/99	6833.88	 6553
1.6 - 75 / 80 / 85 / 90	176A9	1581	11/93>04/97	5069.87	 6782
1.6 - 90	176A9	1581	11/93>04/97	6541.87	 6832
1.7 D	176B3	1697	10/94>04/97	6553.80	 6833
1.7 TD	176A3	1697	07/93>09/99	6536.80	 6835
	176A3	1697	07/93>04/97	6538.80	 6836
1.7 TD - 60 / 70 / Van / Van 60	176A3 / A5	1697	07/93>09/99	6539.80	 6869
	176A3 / A5 / B7	1697	07/93>09/99	5976.80	
1.8 16V	183A1 / 188A6	1747	07/99>06/03	6506.83	
1.8 16V - 130	183A1 / A6	1747	07/99>06/03	6506.88	
1.9 D - 60 / D60 / Van	188A3	1910	07/99>06/03	6832.88	
1.9 JTD - 80 / Van	188A2 / A7	1910	06/95>06/03	6869.88	
Punto II					
1.2	188A4	1242	07/03>	5069.87	
1.2 16V	188A5	1242	07/03>	6782.87	
1.3 JTD	188A9	1248	07/03>	6835.88	
1.4	843A1	1368	07/03>	6782.87	
1.8	188A6	1747	07/03>	6506.88	
1.9 JTD	188A7	1910	07/03>	6869.88	
	188B2	1910	07/03>	6836.88	
Grande Punto NEW					
1.2 V8	199A4.000	1199	09/05>	5069.87	



LISTE D'APPLICATIONS















APPLICATION LIST/ANWENDUNGSLISTE

VEHICULE MODEL FAHRZEUGTYP	MOTEUR ENGINE MOTOR	CYLINDRÉE ENGINE SIZE HUBRAUM	ANNÉE YEAR JAHR	VERNET	PHOTOS PICTURES ZEICHNUNGEN
...Grande Punto					
1.3 JTD - 75ch	199A2.000	1299	09/05>	6981.88	 245F
1.3 JTD - 90ch	199A3.000	1299	09/05>	6981.88	 1514
1.4 8V	350A1.000	1399	09/05>	6986.00	
1.9 JTD - 120ch	939A1.000	1899	09/05>	6978.88	
1.9 JTD - 130ch	199A5.000	1988	09/05>	6978.88	
Regata					
1.1 - 60	146A4	1116	07/86>12/90	5071.85	 1519
1.3 - 70	138B2 / B7	1301	09/83>06/86	5070.85	 1538
	149A7 / C4	1299	07/86>12/90	5071.85	
1.5	138C2	1498	07/86>12/90	6565.87	
1.5 - 75 / 85	138B3 / C2 / C3	1498	09/83>12/90	5071.85	
	149A5	1498	07/86>02/88	5071.85	
1.6 - 100	138AR	1585	08/86>12/90	245F.79	 3905
	149A4	1585	09/84>12/90	1514.81	 5069
	149A4 / C3	1585	07/86>12/90	1538.88	
1.7 D - 1700 D	136B6	1714	09/84>06/86	5074.80	 5070
	149B3	1697	09/83>06/86	5687.80	 5071
1.9 D - 1900 D	149A1	1929	09/83>06/86	5687.80	
1.9 TD - 1900 TD	831D1	1929	09/86>12/90	6550.80	
Ritmo					
1.0 - 60	127A6	1049	02/80>03/85	1519.82	 5074
1.1 - 50	146A	1116	04/85>12/88	1514.81	 5687
1.1 - 60	138A	1116	05/78>10/82	3905.82	 6264
	138B / B1	1116	11/82>03/85	5070.85	 6550
	138C1 / 146A / A4	1116	04/85>10/88	5071.85	
1.3 - 65 / 70	138 A1 / B3 / A7	1299	05/78>10/88	5071.85	 6264
	138A1	1301	05/78>10/88	3905.82	 6550
	138A1 / B2	1301	05/78>10/87	5070.85	
1.3 - 75	128A3	1301	01/81>10/82	3905.82	 6565
1.5 - 75 / 85	138A2 / B / B3 / 149A5 / B	1498	05/78>10/88	5071.85	 6978
	138A4 / A2 / B3 / C2	1498	05/78>10/88	3905.82	
	149A / A5	1498	05/78>10/88	3905.82	
1.5 - 85	138AE	1498	01/8>10/82	3905.82	
1.6 - 100	149A4	1585	04/85>03/88	1514.81	 6981
1.6 - 100 / 105	138AR	1585	03/82>03/85	245F.79	 6986
1.6 - 90	149C2	1595	04/85>12/88	1514.81	
1.7 D - 60 D	138 A5 / B6 / B3	1714	02/80>03/88	5074.80	
1.9 D - 1900 D Turbo	149A1	1929	02/86>10/88	5687.80	
2.0	154C5	1995	03/82>10/82	245F.79	
2.0 - 125 / 130	FIAT03 / 04	1995	04/85>10/88	245F.79	
Seicento					
0.9	1170A1	899	03/98>	6264.87	
1.1	176B2 / 187A1	1108	03/98>	5069.87	



LISTE D'APPLICATIONS

APPLICATION LIST/ANWENDUNGSLISTE

VEHICULE MODEL FAHRZEUGTYP	MOTEUR ENGINE MOTOR	CYLINDRÉE ENGINE SIZE HUBRAUM	ANNÉE YEAR JAHR	VERNET	PHOTOS PICTURES ZEICHNUNGEN
Siena					
1.2	178B5 / B7 / C4	1242	09/98>12/01	5069.87	
	178D7055	1242	01/02>	6782.87	
	188A4 / A5	1242	01/02>	6782.87	
1.4	178B2	1372	11/97>12/01	6541.87	
1.6	178D2	1580	06/99>	6504.88	
	178D2	1580	11/97>12/01	6590.88	
1.6 16V	178B3 / C7 / C8	1581	11/97>	6504.88	
	178B3 / C7 / C8	1581	11/97>	6590.88	
	182B6	1596	01/02>	6590.88	
1.7 D	176B3	1697	09/98>12/01	6553.80	
1.7 TD	178C9	1697	06/99>12/01	6539.80	
1.9 DS	223A6	1910	01/02>	6833.88	
Stilo					
1.2	188A5	1242	09/01>12/03	6782.87	
1.4	843A1	1368	09/01>	6782.87	
1.6	178E7	1596	01/04>	6590.88	
1.6 16V	192B3	1596	01/04>08/04	6590.88	
1.6 16V / Multiwagon 16V	182B6	1581	09/01>	6590.88	
1.8 16V / Multiwagon 16V	192A4	1747	09/01>	6506.88	
1.9 JTD	192A5	1910	01/04>	6882.88	
	192A5 / 192B1	1910	01/04>08/04	6826.88	
	192A9 / 937A4	1910	09/04>	6826.88	
1.9 JTD - Van / Multiwagon	192A1 / A3	1910	09/01>	6826.88	
2.4 20V	192A2	2446	09/01>	6834.88	
Tempra					
1.4	159A2 / 160A 1 / 836A4	1372	11/89>02/96	6250.87	
	159A2 / 160A1	1372	11/89>10/96	6598.87	
	159A2 / 160A1	1372	11/89>02/93	1538.88	
1.6	159A / 835C1	1581	11/89>02/96	6250.87	
	159A / B / 835C1	1581	11/89>10/96	6598.87	
	159A / B9	1581	07/94>10/96	6541.87	
	159A3	1581	11/89>02/93	1538.88	
1.8	159A4	1756	11/89>02/93	6250.87	
1.8 / 16V	159A / 835C / 836A	1756	11/89>10/96	1538.88	
1.9 D	160A7	1929	11/89>10/96	5687.80	



LISTE D'APPLICATIONS

APPLICATION LIST/ANWENDUNGSLISTE

VEHICULE MODEL FAHRZEUGTYP	MOTEUR ENGINE MOTOR	CYLINDRÉE ENGINE SIZE HUBRAUM	ANNÉE YEAR JAHR	VERNET	PHOTOS PICTURES ZEICHUNGEN
...Tempra					
1.9 TD	160A6	1929	02/92>11/96	6254.80	 1538
	160D1	1929	03/93>10/96	5975.80	 4885
	160D1	1929	03/93>10/96	6537.80	
1.9 TD (A/C)	160A6	1929	02/92>10/96	6255.80	
	160A6	1929	07/92>10/96	6263.80	
1.9 TD / TDS	160A6	1929	11/89>10/96	5688.80	
1.9 TDS	160A6 / B6	1929	04/90>02/93	6261.80	
2.0	159A6	1995	11/89>02/93	6250.87	 5069
2.0 / 2.0 4x4	159A6	1995	11/89>12/96	1538.88	 5108
Tipo					
1.1	160A3	1108	01/88>02/93	5069.87	 5130
1.4	159A / 160A	1372	01/88>	6598.87	 5687
	159A2 / 160A1 / 836A4	1372	01/88>10/95	6250.87	
1.6	159 / 160 / 835	1581	01/88>	6598.87	
	159A / 160A / 835C1	1581	01/88>10/95	6250.87	
	1602.ACT	1585	07/88>02/93	1538.88	
1.7 D	149B4	1697	01/88>02/93	5687.80	 5688
	149B4	1697	03/93>10/95	6261.80	 5975
1.8	159A4 / 835C2 / 835C4	1756	04/89>09/93	1538.88	
1.9 D	160A7	1929	10/89>02/93	5687.80	 6250
	160A7	1929	03/93>10/95	6261.80	 6254
1.9 TD	160D1	1929	02/92>	5975.80	
1.9 TD (A/C)	160A6	1929	02/92>	6263.80	
	160D1	1929	02/92>	6537.80	
1.9 TD / TDS	160A6 / 160D1	1929	01/88>10/95	5688.80	 6255
	160A6 / B6	1929	06/90>10/95	6261.80	 6261
2.0 16V	154E1 / 159A / 836A3	1995	06/90>12/94	1538.88	
Ulysse					
1.8	LFW	1761	03/96>08/02	5108.89	
1.9 D / TD	XUD9	1905	06/94>08/02	5130.83	
2.0	EW10J4	1997	10/98>	6332.89	 6263
2.0 / Turbo	RFU / RGX	1998	06/94>08/02	5108.89	 6332
2.0 16V	RFN	1998	10/98>	6332.89	
	RFV	1998	10/98>08/02	4885.83	
2.0 JTD	RHZ / DW10ATED4	1997	10/99>	5130.83	
2.1 TD	P8C	2088	03/96>08/02	5130.83	 6537
2.2 JTD	DW12ATED4	2179	09/02>	5130.83	 6598



LISTE D'APPLICATIONS

APPLICATION LIST/ANWENDUNGSLISTE

VEHICULE MODEL FAHRZEUGTYP	MOTEUR ENGINE MOTOR	CYLINDRÉE ENGINE SIZE HUBRAUM	ANNÉE YEAR JAHR	VERNET
...Ulysse				
3.0	ES9J4S	2946	09/02>	CT1743.82
Uno				
0.9 - 45	146A	903	01/83>02/92	6073.85
1.0	146B4	994	10/89>12/93	1519.82
1.0 - 45	146B4	994	10/89>12/93	6073.85
	156A2	999	10/85>12/93	5069.87
1.1 - 55 / 60	138B	1116	04/83>04/84	5070.85
	138B / 146A	1116	04/84>12/92	5071.85
	146A / 156C / 160A	1108	10/89>12/93	5069.87
	146A6	1116	10/87>12/95	1519.82
1.3 - 70	138B2 / 149B7	1301	04/83>04/84	5070.85
1.3 - 70 / Turbo	138B / 146A	1301	04/84>03/91	5071.85
1.3 D	127A5	1301	05/83>06/86	5686.80
	146B1	1301	10/89>03/92	6564.80
1.4	146A7 / C1	1372	10/89>12/93	6565.87
	146C2 / 160A1	1372	10/89>12/93	6598.87
1.4 TD - 70 TDS	146B3	1367	04/86>07/93	5687.80
1.4 Turbo	146A8	1372	10/89>09/93	6560.80
1.5 - 75	149C1	1498	10/89>12/93	5071.85
1.7 D - 60 D	146B / 149B	1697	10/89>08/95	5687.80
1.9 D	149B5	1929	07/90>03/94	6550.80

FIAT



Doblo				
1.2	223A5	1242	10/00>	5069.87
1.3 JTD	188A9	1351	01/04>	6835.88
1.4 8V	350A1		09/05>	6986.00
1.6	182B6	1596	10/01>	6590.88

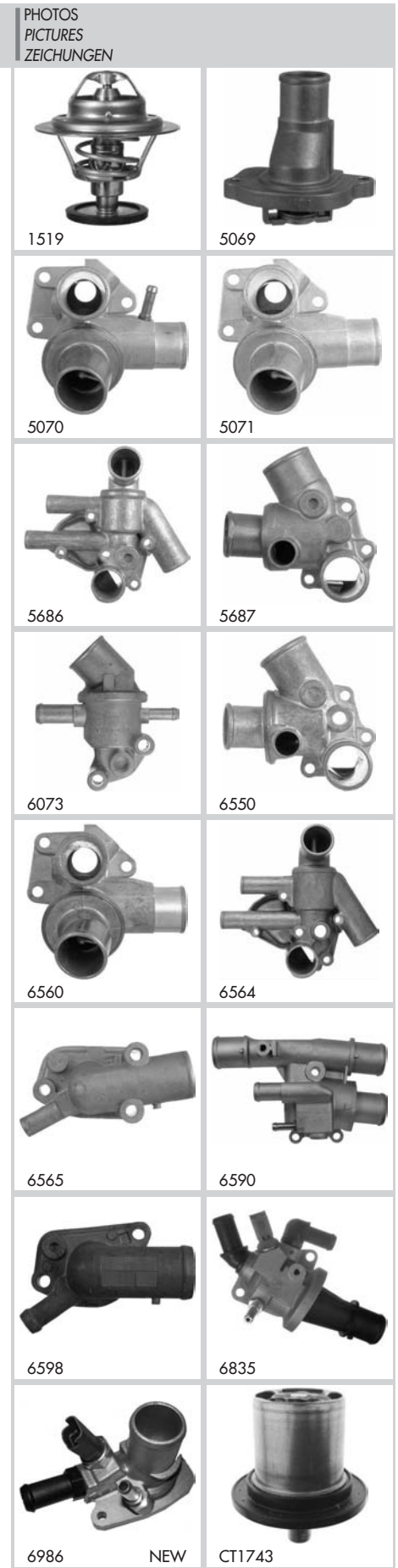



LISTE D'APPLICATIONS

















APPLICATION LIST/ANWENDUNGSLISTE

VEHICULE MODEL FAHRZEUGTYP	MOTEUR ENGINE MOTOR	CYLINDRÉE ENGINE SIZE HUBRAUM	ANNÉE YEAR JAHR	VERNET	PHOTOS PICTURES ZEICHNUNGEN
...Doblo					
1.9 D	223A6	1910	10/00>	6832.88	 0963
1.9 JTD	182B9	1910	10/01>	6826.88	 1519
Ducato					
1.8	169B	1796	11/81>12/90	2620.82	 1522
1.9 D	XUD9	1905	06/98>12/01	5130.83	 2620
1.9 D / TD	149B1 / 149B2	1929	10/87>01/94	5687.80	 3309
	230A2	1929	02/94>12/01	6722.80	
1.9 TD	230A3 / A4	1929	02/94>12/01	6554.80	 4885
	XUD9	1905	06/98>12/01	4885.83	
2.0	170B170D	1971	11/81>01/94	2620.82	 5069
	RFL / XU10	1998	02/94>	5108.89	
2.0 JTD	RHV	1997	01/02>	5130.83	 5108
2.5 D	8144-61	2445	11/81>05/85	3309.74	
	8144-61	2445	06/85>01/94	6581.82	 5130
	CRD93	2500	11/81>05/85	0963.86	
	CRD93	2500	06/85>01/94	6581.82	 5687
2.5 D / TD / TDi	8140-47 / 47R / 67	2499	02/94>12/01	6581.82	
2.5 TD	8144-21	2445	06/85>01/94	6581.82	 6554
2.8 D / TDi / JTD	8140-43 / 43S / 63	2798	01/98>	6581.82	
Duna					
1.1 - 60	146A6	1116	03/87>12/91	1519.82	 6581
1.3 - 70	146A5	1301	03/87>12/91	1519.82	
1.7 D - 60 D	149B3	1697	03/87>12/91	5687.80	 6722
Fiorino					
0.9	127GL	903	09/78>05/85	1522.87	 6826
1.0	127A	1049	09/79>10/89	1519.82	
	146B2	1049	05/88>	5069.87	 6832
1.1	146A9	1116	03/88>06/93	1519.82	
1.3	146A5	1301	03/88>12/94	1519.82	



LISTE D'APPLICATIONS













APPLICATION LIST/ANWENDUNGSLISTE

VEHICULE MODEL FAHRZEUGTYP	MOTEUR ENGINE MOTOR	CYLINDRÉE ENGINE SIZE HUBRAUM	ANNÉE YEAR JAHR	VERNET	PHOTOS PICTURES ZEICHUNGEN
...Fiorino					
1.3 D	127A5	1301	02/81>10/89	1519.82	 1519
	146B1	1301	07/90>06/93	6564.80	 5071
	146B1 / 127A5	1301	11/83>	5686.80	 5686
					 5687
1.3 TDS	146B1	1301	03/88>	5687.80	
1.4	146C5 / 146D5	1372	08/93>09/00	6541.82	
1.5	149C1	1498	07/90>06/93	5071.85	 5688
					 6254
1.6	146C6 / D6	1581	08/93>09/00	6541.82	
1.7 D	146B2 / 149B3	1697	07/90>09/00	5687.80	 6258
	149B4	1697	07/90>06/93	6550.80	 6259
1.7 TDS	146D7	1698	06/96>09/00	6556.80	
Marengo					
1.9 D	160A7	1929	11/89>01/95	5687.80	 6489
					 6541
1.9 JTD	182B4	1910	01/99>	6489.88	 6550
	182B4	1910	01/99>	6551.88	 6551
	186A6	1910	01/99>	6826.88	
1.9 TD	160A6	1929	03/93>01/95	6254.80	 6555
	182A7	1910	01/95>	6555.75	 6556
	182A8	1910	01/95>	6258.75	
	182A8	1910	01/95>	6259.75	 6564
					 6826
1.9 TD / TDS	160A6	1929	11/89>01/95	5688.80	



LISTE D'APPLICATIONS











APPLICATION LIST/ANWENDUNGSLISTE

VEHICULE MODEL FAHRZEUGTYP	MOTEUR ENGINE MOTOR	CYLINDRÉE ENGINE SIZE HUBRAUM	ANNÉE YEAR JAHR	VERNET	PHOTOS PICTURES ZEICHUNGEN
Scudo					
1.6	220A2	1581	07/95>12/03	6541.87	 245F
1.9 D	DW8	1868	07/96>	5130.83	 1410
	DW8B	1868	07/96>	5130.83	
1.9 D / TD	XUD9	1905	07/95>12/03	5130.83	 2620
2.0 16V	EW10	1997	09/00>	6488.89	 5069
2.0 JTD	DW10B	1997	02/00>12/03	5130.83	 5071
	RHX / RHZ	1997	02/00>12/03	5130.83	 5130
Strada					
1.1	146A4	1116	04/85>12/88	5071.85	 5687
1.2	188A4	1242	03/03>	6782.87	 6488
1.2 Pick-Up	178B5	1242	03/99>03/03	5069.87	 6536
1.3	149A7	1301	04/85>12/88	5071.85	 6538
1.5	149A5	1498	04/85>06/88	5071.85	 6541
1.7 TDS Pick-Up	176A3	1697	03/99>03/03	6536.80	 6782
	176A3	1697	03/99>03/03	6538.80	 6832
1.9 Ds	223A6	1910	12/00>	6832.88	 6869
1.9 JTD	188A2	1910	03/03>	6869.88	
2.0	FIAT04	1995	04/85>12/88	245F.79	
Talento					
1.9 D	149B1	1929	03/88>12/94	5687.80	
2.0	170B	1971	11/88>12/94	2620.82	
FORD					
Capri					
1.3	J1E / J2F / J2N	1298	06/79>04/87	1410.92	
	J3C / J3N / JSD	1296	01/78>04/87	1410.92	
1.6	LAC / LAN / LEN	1593	01/78>04/87	1410.92	



LISTE D'APPLICATIONS

















APPLICATION LIST/ANWENDUNGSLISTE

VEHICULE MODEL FAHRZEUGTYP	MOTEUR ENGINE MOTOR	CYLINDRÉE ENGINE SIZE HUBRAUM	ANNÉE YEAR JAHR	VERNET	PHOTOS PICTURES ZEICHUNGEN
...Capri					
2.0	NE3 / NEE / NEN	1993	02/74>04/87	1410.92	 1290
	NYK / NYL	1998	02/74>04/87	1335.80	
	NYK / NYL	1998	02/74>04/87	1335.87	 1335
	NYK / NYL	1998	02/74>04/87	1335.92	
2.3	YYE / YYN	2294	02/74>04/87	1335.80	 1410
	YYE / YYN	2294	02/74>04/87	1335.87	
	YYE / YYN	2294	02/74>04/87	1335.92	
2.8	PRN	2792	01/81>04/87	1335.80	 3319
	PRN	2792	01/81>04/87	1335.87	
	PRN	2792	01/81>04/87	1335.92	
Consul					
1.7	MHA	1699	03/72>08/81	1410.87	 5750
2.0	NEO	1993	03/72>08/81	1410.87	
3.0 V6	HYF	2994	03/72>08/81	1290.88	
Cortina					
1.6	LEE	1592	11/76>07/79	1410.92	 5977
Cougar					
2.0	EDB / NGB	1998	09/98>02/01	5750.88	 5977
2.5 V6	LCB / SEB	2544	09/98>06/00	6578.87	
Escort					
0.9	T1 / T2	939	10/68>08/80	1290.88	 5978
1.1	B / G1 / G2 / L	1098	10/67>08/80	1290.88	
	GLA	1117	08/82>02/86	1290.88	
	GMA / GPA / GSG	1117	08/80>07/90	1410.92	
	GUF	1118	09/90>03/91	6244.92	
1.3	J1 / J2 / J3 / R	1298	10/67>08/80	1290.88	 6244
	J4 / J6A	1299	01/95>09/01	1410.87	
	JBD / JBE / J6A	1299	09/90>12/94	6244.92	
	JLA / JPA	1297	08/83>07/90	1410.87	
	JPA	1296	08/80>07/83	1410.92	
1.4	F6F / F6G / FU	1392	01/86>12/94	1410.87	
	FUA / FUH / F4B	1392	01/86>09/01	1410.87	 6526
1.6	L1E / L1H / L1K	1597	09/92>09/01	5750.88	
	L3	1598	10/71>08/80	1290.88	
	LNA / LNB / LPA	1597	08/81>09/90	1410.87	
	LPA	1597	08/80>07/81	1410.92	
	LRA / LRB / LUE	1597	02/82>09/90	1410.87	
	LUA / LUC / LUJ	1597	08/80>12/94	1410.87	
	LUK / LJE / LJF	1597	09/90>12/94	1410.87	
1.6 D	LT	1608	04/84>12/89	1335.87	
1.8	RDA / RKC / RQB	1796	01/92>09/01	5750.88	
1.8 D	RT / RTE / RTF	1753	08/88>09/01	6526.88	
1.8 TD	D18T	1753	07/93>	1335.87	
	RFD / RFS / RV	1753	07/93>09/01	6526.88	
2.0	DH20	1998	02/91>	6526.88	
	N5E / N5F	1993	03/92>12/95	5978.82	
	N7A	1998	02/91>08/96	3319.88	
	NE	1993	06/76>08/80	1410.92	
Explorer					
4.0i 4WD	40EFI	3958	01/90>	5977.92	
Fiesta					
0.9	TKA / TLA / TKB	957	06/76>07/89	1290.92	
1.0	TLB	999	04/89>10/89	1290.88	
	TLB / C4	999	10/89>04/99	6244.92	



LISTE D'APPLICATIONS

APPLICATION LIST/ANWENDUNGSLISTE

VEHICULE MODEL FAHRZEUGTYP	MOTEUR ENGINE MOTOR	CYLINDRÉE ENGINE SIZE HUBRAUM	ANNÉE YEAR JAHR	VERNET	PHOTOS PICTURES ZEICHNUNGEN
...Fiesta					
1.1	GL-CVH	1117	06/76>07/89	1290.92	 1290  1335
	GUE	1118	02/89>12/92	1290.92	
	GUE / G6A	1118	02/89>10/89	1290.88	
	GUE / G6A	1118	10/89>07/95	6244.92	
1.2 16V	DHA / B / C / D	1242	08/95>03/02	6245.82	 1410  5750
1.3	J3E	1296	03/77>07/83	1290.92	
	J3E / JP	1296	08/83>12/85	1410.92	
	J4C / J4J / J4L / J6B	1299	10/89>03/02	6244.92	
	JBC / J6B	1299	02/89>10/89	1290.88	
1.4	JBC / JJA / JJC / JJE	1299	10/89>03/02	6244.92	 6244  6245
	FUA	1392	01/86>07/89	1410.92	
1.4 16V	FUF / F4A / F6E	1392	02/89>07/95	1410.87	 6526  6837
	DURA14 / FHA / FHE	1388	01/96>03/02	6245.82	
1.6	L3A	1597	10/81>08/83	1290.92	 6838  6874
	LJC / LJD / LNA	1597	08/89>03/92	1410.87	
	LU / LUC / LUH	1597	02/84>01/94	1410.87	
	ZL16	1596	10/99>03/02	6838.82	
1.6 16V	L1G	1597	02/94>07/95	5750.88	 6875
1.6 D	LTB	1608	02/84>06/89	1335.87	
1.8 16V	RDA / RDB	1796	02/92>07/95	5750.88	
1.8 D	RTC	1753	02/89>07/95	1335.87	
1.8 D	RTC / RTD	1753	02/89>07/95	6526.88	 6875
	RTD / RTJ / RTK	1753	08/95>03/02	6526.88	
	1.8 TD	RFE	1753	05/91>07/95	
1.8 TD	RFE / DI-TD	1753	05/91>03/02	6526.88	 6875
Fiesta II					
1.2 16V	M7JA / M7JB	1242	03/02>	6837.82	 6838  6874
1.3	DURA13 / A9JA / BAJA	1299	03/02>	6838.82	
1.4	DURA14	1388	03/02>	6245.82	
	FXJA	1388	03/02>	6837.82	
1.4 TDCi	14TDCI	1398	03/02>	6874.83	 6875
1.6	DURA16	1596	03/02>	6245.82	
	FYJA	1596	03/02>	6837.82	
	ZL16	1596	03/02>	6838.82	
1.6 TDCi	HHJA	1560	11/04>	6875.83	
Focus					
1.4	FXDA / FXDC	1388	08/98>11/02	6245.82	 6875
	FXDA / FXDC	1388	11/01>11/02	6837.74	
	FXDA / FXDC	1388	11/02>	6837.82	
1.6	DURA16-E4	1596	10/03>	6837.82	
	FYDA / FYDC	1596	08/98>11/02	6245.82	
	FYDA / FYDC	1596	11/01>11/02	6837.74	
	FYDA / FYDC	1596	11/02	6837.74	
1.8	EYDA / EYDC	1796	10/98>	5750.88	
1.8 TDCi	LD18TC	1753	05/01>	6526.88	
1.8 TDi	C9D / C9DC	1753	10/98>	6526.88	
2.0	D20RS / ZH20EST	1988	11/01>	5750.92	
	EDDA / EDDC	1988	10/98>	5750.88	
Focus C-MAX					
1.6	DURA16-E4	1596	10/03>	6837.82	
	DURA16-E4	1596	10/03>	6837.74	
	ZH16-E4	1596	10/03	6837.74	
1.6 TDCi	D16TDCI	1560	10/03>	6875.83	



LISTE D'APPLICATIONS





APPLICATION LIST/ANWENDUNGSLISTE

VEHICULE MODEL FAHRZEUGTYP	MOTEUR ENGINE MOTOR	CYLINDRÉE ENGINE SIZE HUBRAUM	ANNÉE YEAR JAHR	VERNET	PHOTOS PICTURES ZEICHUNGEN
...Focus C-MAX					
1.8	ZH18-20	1798	10/03>	6879.89	 1335
2.0 TDCI	D20TDCI	1997	10/03>	6756.84	 1410
Fusion					
1.4	DURA14	1388	06/02>	6245.82	 1535
1.4	FXJA	1388	06/02>	6837.82	 3319
1.4 TDCi	14TDCI / F6JA	1398	06/02>	6874.83	
1.6	DURA16	1596	06/02>	6245.82	 4947
1.6	FYJA	1596	06/02>	6837.82	 5973
1.6 TDCi	DURATQ16	1560	11/04>	6875.83	
Galaxy					
1.8 TDCi		1799	09/05>	6526.88	 6245
1.9 TDi	MF / MG	1896	11/95>	6273.87	 6273
2.0	NSE	1998	05/95>03/00	3319.88	
		1998	09/05>	6879.89	
2.3	Y5	2295	01/97>03/00	3319.88	 6526
2.8 VR6	PW	2792	05/95>03/00	5973.80	 6756 NEW
Granada					
2.0	NYP	1993	09/77>08/82	1410.87	
2.0 V6	NEP	1999	09/77>08/82	1335.87	 6874
2.1 D	WT	2112	09/78>08/81	1535.80	 6837
2.3	YY	2294	09/77>08/82	1335.80	
	YY	2294	09/78>08/82	1335.87	
	YY	2294	09/77>08/82	1335.92	 6875
2.5 D	STR	2498	09/77>08/82	1535.80	
	STR	2499	08/81>08/82	4947.81	 6879
2.8	PY / PR	2792	09/77>08/82	1335.80	
	PY / PR	2792	09/77>08/82	1335.87	
	PY / PR	2792	09/77>08/82	1335.92	



LISTE D'APPLICATIONS

APPLICATION LIST/ANWENDUNGSLISTE

VEHICULE MODEL FAHRZEUGTYP	MOTEUR ENGINE MOTOR	CYLINDRÉE ENGINE SIZE HUBRAUM	ANNÉE YEAR JAHR	VERNET	PHOTOS PICTURES ZEICHNUNGEN
Ka					
1.3	DURA13 / A9JA	1299	10/02>	6838.82	
	J4D / J4K / J4M	1299	09/96>10/02	6244.92	
	JJB / JJD / JJF	1299	09/96>10/02	6244.92	
1.6 / SportKa	BL16EFI	1598	02/03>	6838.82	
StreetKa NEW					
1.6	BL16EFI	1599	03/03>	6838.82	
Maverick					
2.4	BF	2389	02/93>04/96	6314.82	
2.7 TD	VP	2663	02/93>04/96	6319.82	
	VP	2663	02/93>04/96	6319.88	
Mondeo					
1.6	L1 / L1F / L1J	1597	01/93>08/00	5750.88	
1.8	RKA / RKJ	1796	01/93>08/00	5750.88	
1.8 TD	RFN	1753	08/96>08/00	6526.88	
2.0	NGA	1998	08/96>08/00	5750.88	
2.5 V6	SE / SEA / LCBD	2495	08/96>08/00	6578.87	
Mondeo II					
1.8 16V	CGBA / CGBB	1798	10/00>	6939.98	
	CHBA / CHBB	1798	10/00>	6939.98	
1.8 SCi	ZH18	1798	06/03>	6939.98	
2.0	CJBA / CJBB	1999	10/00>	6939.98	
2.0 Di	D5BA / D6BA	1998	10/00>	5077.88	
2.0 TDCi	PD-130	1998	10/01>	5077.88	
2.0 TDCi	D6BA / D5BA	1998	10/00>	5077.88	
2.0 TDDi	D5BA	1998	06/03>	6578.87	
2.2 TDCi		2199	09/05>	5077.88	
2.5	LCBD	2495	10/00>	6578.87	
3.0	MP30	2967	03/02>	6578.87	
Orion					
1.3	JB	1297	09/90>09/93	5750.88	
	JP / JPA	1296	09/83>08/90	1410.87	
1.4	FUA	1392	02/86>08/90	1410.87	
	FUH / F6F / F6G	1392	09/90>09/93	5750.88	
1.6	L1E / L1E / L1F	1597	09/90>09/93	5750.88	
	LPA / LUA	1597	09/83>08/90	1410.87	
	LU / LUJ / LUK	1597	09/90>09/93	5750.88	
1.6 D	LT	1608	09/83>02/86	1335.87	
	LT	1608	09/83>07/88	6248.87	
1.8	RDA / RDB / RQB	1796	01/92>09/93	5750.88	
1.8 D	RT	1753	08/88>09/93	6526.88	
	RT	1753	08/88>09/93	1335.87	
Puma					
1.4	F6F	1392	05/97>12/01	6526.88	
	FHD / FHF	1388	01/98>10/00	6245.82	
	FHD / FHF	1388	01/98>10/00	6837.82	
1.6	ZH16S	1596	09/00>12/01	6245.82	
	ZH16S	1596	09/00>12/01	6837.82	
1.7	MHA	1679	05/97>12/01	6837.82	
1.7 16V	MHA	1679	05/97>12/01	6245.82	
Ranger					
2.5 D / TD	25D / 25TD	2500	09/00>01/02	6702.82	
2.5 TD	4GC	2496	01/02>	6702.82	
S-Max NEW					
1.8 TDCi		1799	06/06>	6526.88	

1335

1410

5077

5750

6244

6245

6248

6314

6319

6526

6578

6702

6837

6838

6939

NEW



LISTE D'APPLICATIONS

APPLICATION LIST/ANWENDUNGSLISTE

VEHICULE MODEL FAHRZEUGTYP	MOTEUR ENGINE MOTOR	CYLINDRÉE ENGINE SIZE HUBRAUM	ANNÉE YEAR JAHR	VERNET
...S-Max				
2.0		1999	06/06>	6879.89
Scorpio				
1.8	REC	1796	03/85>04/87	1410.87
2.0	N8B / N3A / N9B	1998	11/89>	5977.88
	N9F / NSD / NSE	1998	02/92>	5977.88
	NEL / NRA	1993	03/85>10/89	1410.87
2.3 16V	Y5A	2295	05/96>	5977.88
2.4	ARC / ARD	2394	11/86>10/94	5750.88
2.5 D	STR	2499	11/85>07/90	1183.83
2.5 TD	SCB / SCC / SCD	2500	09/93>	5963.80
	SFA	2499	06/88>09/93	1183.83
2.8	PRE	2792	03/85>10/86	1335.80
	PRE	2792	03/85>10/86	1335.87
	PRE	2792	03/85>10/86	1335.92
2.9	BOA / BOB	2935	05/91>	5750.88
	BRC / BRD / BRF	2933	11/86>10/94	5750.88
Sierra				
1.3	JCT	1274	08/82>07/85	1410.92
	JCT	1274	08/84>07/85	1410.87
1.6	L6B	1597	05/89>12/92	5977.88
	LCS / LCT / LSD / LSE	1593	08/82>01/93	1410.87
	LCT / LSD / LSE	1593	08/82>01/93	1410.92
1.8	R2A / RED	1769	07/88>07/93	6231.88
	REB	1796	10/84>12/86	1410.92
	RED / REB	1796	10/84>07/93	1410.87
1.8 TD	RFA	1753	01/90>07/93	1335.87
	RFA / RFB	1753	01/90>07/93	6526.88
2.0	N5 / N4A	1993	04/86>12/90	1410.87
	N5C / N5D	1993	02/90>07/93	5978.82
	N8A / N9A / N9C	1998	07/88>07/93	5977.88
	N8A / N9A / N9C	1998	07/88>07/93	5977.88
	NES / NET	1993	08/82>12/90	1410.92
	NES / NET / NRB	1993	08/82>12/86	1410.87
	NY	1998	08/82>07/86	1335.80
2.3	YY	2294	08/82>07/86	1335.80
	YY	2294	08/82>07/86	1335.87
	YY	2294	08/82>07/86	1335.92
2.3 D	YTR / YTT	2304	01/87>07/90	4947.81
	YTT	2304	10/82>12/86	1183.83
2.8	PR6 / PR7 / PRG	2792	01/83>01/93	1335.80
	PR6 / PR7 / PRG	2792	01/83>01/93	1335.87
	PR6 / PR7 / PRG	2792	01/83>01/93	1335.92
2.9	B4A / B4B	2933	06/88>01/93	5750.88
Taurus				
1,3	TL	1294	10/70>08/82	1410.87
1.6	LCJ / LEE / LER	1592	02/76>07/82	1410.92
2.0	NEO	1993	02/76>07/82	1410.92
	NX	1998	02/76>07/82	1335.80
	NX	1998	02/76>07/82	1335.87
	NX	1998	02/76>07/82	1335.92





LISTE D'APPLICATIONS

APPLICATION LIST/ANWENDUNGSLISTE

VEHICULE MODEL FAHRZEUGTYP	MOTEUR ENGINE MOTOR	CYLINDRÉE ENGINE SIZE HUBRAUM	ANNÉE YEAR JAHR	VERNET
...Taunus				
2.3	VY	2293	02/76>07/82	1335.80
	VY	2293	02/76>07/82	1335.87
	VY	2293	02/76>07/82	1335.92
FORD 				
Courrier				
1.3 STD	J4C / J6B / JBC	1299	08/91>	6244.92
1.8 STD	RTC / RTD / RTJ	1753	08/91>	6526.88
P100				
1.8 TD Pick-Up	RFA	1753	02/89>	6526.88
2.0 Pick-Up	NAE	1993	01/88>	1410.87
Tourneo Connect				
1.8	ZH18	1796	05/02>	6526.88
	ZH18	1796	05/02>	5750.92
1.8 TDCi	D18DI / D18TCI	1753	05/02>	6526.88
Transit				
1.6	LAT	1593	01/78>12/91	1410.87
	LAT	1593	01/78>10/85	1410.92
1.8	ZH18	1796	05/02>	5750.92
1.8 TDCi	D18DI / D18TCI	1753	05/02>	6526.88
2.0	N6T / NCA	1993	10/89>08/94	1410.87
	NAT / NAV / NBA	1993	01/78>08/94	1410.87
	NAV	1993	01/78>12/85	1410.92
	NSF	1998	09/94>12/99	5977.88
2.5 D	4AB	2496	10/85>09/88	1419.82
	4BC	2496	06/91>08/94	1410.87
	4BC / 4CA	2496	10/88>08/94	6007.88
	4BC / 4CA / 4DA	2496	08/91>08/94	6526.88
	4FB / 4FC / 4FD / 4FA	2500	09/94>12/99	6526.88
	4HB / 4HC	2496	09/94>12/99	6526.88
2.5 TD	4EA	2496	08/91>03/99	6526.88
	4EB / 4EC / 4ED	2496	09/94>12/99	6526.88
	4GA / GB / GC / GD / GE	2496	09/94>12/99	6526.88
	4GB / 4GC / 4GD / GE / GA	2500	09/94>12/99	6526.88
2.9 V6	BRT	2933	08/91>08/94	1410.87

FSO-POLSKI

125				
1.3	116C000	1295	10/72>04/85	1519.82
	116C000	1295	04/75>04/85	6593.82
	116C076 / 56	1295	04/75>09/79	1519.82
	116C076 / 56	1295	04/75>09/79	6593.82
1.5	115C000	1295	10/71>04/75	1519.82
	115C000	1481	10/71>04/75	6593.82
	115C076 / 56	1481	04/75>09/79	6593.82
	116C076 / 56	1481	04/75>09/79	1519.82
	AB	1481	09/79>	1519.82
	AB	1481	09/79>	6593.82
Atou				
1.4	14K4F	1396	10/95>	5504.82
1.6	CE	1598	10/95>	6593.82

PHOTOS PICTURES ZEICHNUNGEN	
 1335	 1410
 1419	 1519
 5504	 5750
 5977	 6007
 6244	 6526
 6593	



VEHICULE MODEL FAHRZEUGTYP	MOTEUR ENGINE MOTOR	CYLINDRÉE ENGINE SIZE HUBRAUM	ANNÉE YEAR JAHR	VERNET
Caro				
1.4	14K4F	1396	02/94>	5504.82
1.5	AE / AF / AB	1481	07/91>	6593.82
1.6	CB / CE	1598	07/91>	6593.82
1.9 D	XUD9 / K	1905	07/92>	5130.83
Polonez				
1.3	BA / BB	1295	11/78>	6593.82
1.5	AA / AB / AC / AD	1481	11/78>	6593.82
1.6	CB	1598	11/87>	6593.82
Truck				
1.6	CB / CE	1598	07/92>	6593.82
1.9 D	XUD9A / K	1905	07/92>	5130.83

HONDA









Accord				
1.6	A16A1	1598	10/85>08/89	5076.82
	A16A1	1598	10/85>08/89	5076.88
	D16B6	1590	09/98>02/03	6296.78
	D16B6	1590	09/98>01/03	6296.78
	D16B6 / 7	1590	09/98>02/03	6267.78
	EL	1590	04/76>09/85	1416.82
	EL	1602	08/78>09/83	5076.82
1.8	EZ / EG	1598	08/77>09/85	5076.82
	ET1	1829	09/83>09/85	5076.82
	F18A2	1849	09/89>09/93	6599.78
	F18A3 / A4	1849	07/93>	6296.78
2.0	F18A3 / A4 / B2	1849	07/93>01/03	6267.78
	A20A	1958	08/85>	5076.82
	A20A / B20A	1955	10/85>08/89	5076.82
	A20A1 / 102 / 104	1955	10/85>08/89	5076.88
	A20A2 / 3 / 4	1955	10/85>18/89	5076.88
	B20A	1958	02/87>08/89	5076.88
	F20A2 / 3 / 4 / 5 / 8	1997	09/89>10/93	6599.78
	F20A7 / F20B / F20Z	1997	07/91>01/03	6267.78
	F20Z1	1997	07/95>08/98	6296.78
	F20Z3	1997	07/92>08/98	6267.78
2.0 TD / TDi	20T2N	1994	03/96>02/03	6880.00
2.2	F22A7 / A8	2156	07/91>08/93	6267.78
	F22B1 / B4 / B5	2156	09/93>12/97	6267.78
	F22Z2	2156	07/95>08/98	6296.78
	H22A7	2157	09/98>02/03	6297.78
	F22A / F22B / F22Z	2156	07/91>	6267.78
2.2 16V	F22A3 / 6 / 7 / 8	2156	09/89>09/93	6599.78
	F2BI	2295	09/93>	6267.78
2.2 Vti	N22A1	2204	02/04>	6297.78
2.3	F23A3 / H23A3	2259	07/93>	6267.78
	F23Z5	2254	11/00>01/03	6267.78
3.0 Coupé	J30A1	2997	10/97>	6583.76
Acty				
0.5	EH	546	01/82>12/87	5075.82
	EH	546	01/82>12/87	5075.88
Ballade				
1.3	EJ	1335	01/80>12/83	5075.88
	EJ	1335	01/80>12/83	5075.82
	EV2	1342	01/83>12/86	6599.78





LISTE D'APPLICATIONS





APPLICATION LIST/ANWENDUNGSLISTE

VEHICULE MODEL FAHRZEUGTYP	MOTEUR ENGINE MOTOR	CYLINDRÉE ENGINE SIZE HUBRAUM	ANNÉE YEAR JAHR	VERNET	PHOTOS PICTURES ZEICHNUNGEN
...Ballade					
1.5	EM	1488	01/80>12/83	5075.88	 1416  5075
	EM	1488	01/80>12/83	5075.82	
	EW	1488	03/86>12/90	6599.78	
City					
1.2	D12A / ER / ERT	1238	10/81>	5076.88	
Civic					
1.2	D12B1 / ZA	1238	09/87>12/91	6267.78	 5076  6252
	EB	1169	09/79>09/87	1416.82	
	EB	1169	08/79>08/83	5075.82	
	ZA	1169	09/83>09/87	6267.78	
	ZA	1169	09/83>09/87	6599.78	
1.3	D13B / EV	1342	09/87>09/95	6599.78	 6267  6296
	D13B2	1343	09/91>09/95	6267.78	
	EN	1335	08/79>08/83	5075.82	
	EV	1342	09/83>09/87	5076.82	
	EV	1342	09/83>09/87	6599.78	
	LDA1	1339	07/03>	6267.82	
1.4	D14A1	1396	09/87>09/91	6599.78	 6599  6959 NEW
	D14A1 / 3 / 4	1396	09/87>03/01	6267.78	
	D14A2 / 5 / 7 / 8	1396	01/95>	6296.78	
	D14Z5 / 6	1396	04/01>09/03	6267.78	
1.5	D15B / D15Z	1493	09/87>03/01	6267.78	
	D15Z3 / 8	1493	01/95>06/96	6296.78	
	ED	1488	01/72>08/79	5076.82	
	EW	1488	09/83>08/87	6599.78	
1.6	B16A / D16A	1595	09/87>09/95	6267.78	
	B16A / D16A / D16Z	1595	08/89>03/01	6599.78	
	D16A	1590	09/87>09/95	6599.78	
	D16B2 / D16Y	1595	01/95>03/01	6296.78	
	D16V / D16W6	1590	09/97>09/03	6267.78	
	D16V1 / D16W7	1595	04/01>	6267.78	
	D16Y	1590	03/96>03/01	6267.78	
	D16Y / D16Z	1595	08/90>	6267.78	
	D16Z	1590	09/91>09/95	6267.78	
1.7	D17A8	1668	04/01>	6267.78	
1.7 CDTi	4EE2	1686	04/02>	6252.85	
1.8 / 1.8 VTi	B18C4 / D18C4	1797	07/96>03/01	6267.78	
2.0	K20A2 / K20A3	1998	09/01>	6959.00	
2.0 TDi	20T2N12	1994	07/96>03/01	6296.78	
Concerto					
1.4	D14A1	1396	01/89>09/91	6267.78	
1.5	D15B2	1493	01/89>09/95	6267.78	
1.6	D16A / D16Z	1590	01/88>09/94	6267.78	
CR-V					
2.0	B20B3	1973	01/97>02/02	6267.78	
	B20Z	1973	06/99>07/01	6267.78	
	K20A4	1998	03/02>	6959.00	
CRX					
1.5	EW3	1488	09/83>08/87	6599.78	
1.6	B16A / D16A / D16Z	1595	08/87>02/92	6267.78	
	ZC1 / D16A / Y / Z	1590	03/86>06/95	6599.78	
FR-V NEW					
2.0	K20A4	1998	10/04>	6959.00	



LISTE D'APPLICATIONS

APPLICATION LIST/ANWENDUNGSLISTE

VEHICULE MODEL FAHRZEUGTYP	MOTEUR ENGINE MOTOR	CYLINDRÉE ENGINE SIZE HUBRAUM	ANNÉE YEAR JAHR	VERNET	PHOTOS PICTURES ZEICHUNGEN
HR-V					
1.6 4WD	D16H	1590	10/98>12/99	6267.78	 1416
1.6 4WD / Hyper 4WD	D16W1 / D16W5	1590	10/98>12/99	6267.78	
Insight					
1.0	ECA1	995	03/00>	6267.78	 5076
Integra					
1.5	D15A1	1493	03/85>11/89	6599.78	 6267
1.6 16V	D16A2 / 3	1590	03/85>11/89	6599.78	
1.8 16V	B18C6	1797	11/97>	6267.78	
Jazz					
1.1	ER3	1100	02/84>10/86	5076.82	 6297
1.2	ER1 / 2 / 4	1238	10/81>10/86	5076.82	
	L12A1	1243	01/02>07/02	6267.78	
	L12A1	1243	07/02>	6267.82	
1.4	L12A1	1243	01/02>07/02	6267.88	
	L13A1	1339	01/02>07/02	6267.78	 6599
	L13A1	1339	07/02>	6267.82	
L13A1	1339	01/02>07/02	6267.88		
Legend					
2.5	C25A1 / A2	2493	11/85>09/87	6267.78	 6959 NEW
2.5 24V		2498	01/87>10/90	1416.82	
			2498	01/87>10/90	1416.82
2.7	C27A1 / A2	2675	07/87>	6267.78	
2.7 V6 24V		2690	01/89>	1416.82	
3.2 24V	C32A2	3206	10/90>02/96	6297.78	
3.5 V6 24V	C35A2	3474	03/96>06/03	6297.78	
Logo					
1.3	D13B7	1343	12/98>	6267.78	
NSX					
3.0 V6 24V	C30A3 / A4	2977	03/89>07/01	6297.78	
3.2	C32B2	3179	03/89>07/01	6297.78	
Odyssey					
2.2	F22B8	2156	07/97>	6267.78	
Prelude					
1.6	EL	1602	01/80>10/82	5076.82	
1.8	ET	1829	11/82>09/91	5076.82	
	ET	1829	04/89>09/91	5076.88	
2.0	B20A	1958	09/84>10/92	5076.82	
	B20A1	1958	09/85>09/91	5076.88	
	F20A4	1997	10/91>01/03	6267.78	
2.2	F22A2	2156	10/96>09/01	6267.78	
2.2 VTC 16V	H22A2 / H22A5	2157	07/92>03/01	6297.78	
2.3 16V	H23A2	2259	10/91>09/96	6267.78	
Quintet					
1.6	EL	1602	01/80>10/84	5076.82	
S2000					
2.0	F20C	1997	04/99>03/04	6267.78	
2.0 16V	F20C2	1996	04/99>03/04	6297.78	
Shuttle					
2.2 16V	F22B8	2156	01/94>02/98	6267.78	
Stream					
1.7	D17A2	1668	03/01>	6267.78	
2.0	K20A1	1998	03/01>	6959.00	



LISTE D'APPLICATIONS

APPLICATION LIST/ANWENDUNGSLISTE

VEHICULE MODEL FAHRZEUGTYP	MOTEUR ENGINE MOTOR	CYLINDRÉE ENGINE SIZE HUBRAUM	ANNÉE YEAR JAHR	VERNET
HYUNDAI				
Accent				
1.3	G4EH44 / 55 / 62	1341	10/99>01/03	1290.88
	G4EH62	1341	07/94>09/99	6293.82
1.5	G4EK	1495	07/94>09/99	6293.82
	G4EK66	1495	10/99>	1290.88
	G4FK	1495	07/94>	6294.82
1.5 CRDi	D3-EA	1493	04/02>	6319.85
1.6	G4ED	1599	02/03>	6294.82
Amica				
1.0	G4HC	999	02/00>07/01	6484.82
Atos / Atos Prime				
1.0	G4H / G4HC	999	01/98>	6484.82
1.1	G4H46	1086	07/04>	3328.82
Coupé				
1.6 16V	G4GRE2 / 6	1599	05/96>	6294.82
2.0	G4GCG	1975	01/02>	6294.82
2.0 16V	G4GF	1975	05/96>	6294.82
2.7	G6BA-G	2656	01/02>	6297.82
Elantra				
1.5	G4DJJ	1468	12/90>05/95	5075.82
1.6	G4CR	1596	12/90>09/95	5075.88
	G4EDG / G4GR	1599	05/95>	6294.82
1.8	G4CN	1836	06/92>06/03	5075.82
	G4CN	1836	06/92>06/03	5075.88
	G4GM	1795	05/95>	6294.82
2.0 16V	G4GCG / G4GF	1975	03/97>	6294.82
2.0 CRDi	D4-EA	1991	01/01>	6319.85
Excel				
1.2	HYUN02	1238	01/82>10/86	5075.82
1.3	G4DGJA / E	1298	08/89>10/94	5075.82
	G4EH62	1341	07/94>	6293.82
1.5	G4DJJA / E	1468	08/89>10/94	5075.82
	G4EK	1495	07/94>	6293.82
Galopper				
2.5 TDi	D4BH	2476	10/97>	6840.82
3.0	G6A	2972	04/98>	5075.88
Getz				
1.1	G4H46	1086	09/02>	6484.82
1.3	G4EH60	1341	09/02>	1290.88
1.5 CRDi	D3-EA	1493	03/03>	6319.85
1.6	G4GRE2	1599	09/02>	6294.82
H1				
2.4	G4CSS	2351	05/98>	5075.82
2.5 D / TD	D4B	2476	02/00>	6840.82
2.5 TCI	D4BH	2476	02/02>	6840.82
H100				
2.4	G4CSAAS	2351	07/93>	5075.82
Highway Van NEW				
2.0	G4DP	1997	03/00>02/04	6870.82
2.7	DELTA27	2656	03/00>02/04	6297.82
	DELTA27	2656	03/00>02/04	6870.82
Lantra				
1.5	G4DJJA	1468	12/90>05/95	5075.82
	G4DJJE	1468	12/90>05/95	5075.88
	G4EK	1495	09/96>07/00	6580.88

PHOTOS PICTURES ZEICHNUNGEN	
 1290	 3328
 5075	 6293
 6294	 6297
 6319	 6484
 6580	 6840
 6870	



LISTE D'APPLICATIONS

APPLICATION LIST/ANWENDUNGSLISTE

VEHICULE MODEL FAHRZEUGTYP	MOTEUR ENGINE MOTOR	CYLINDRÉE ENGINE SIZE HUBRAUM	ANNÉE YEAR JAHR	VERNET
...Lantra				
1.5 12V	G4EK	1495	09/96>07/99	6293.82
1.6	G4GR	1599	05/95>07/00	6294.82
1.6 16V	G4CR	1596	09/91>05/95	5075.88
1.8	G4GM	1795	05/95>07/00	6294.82
1.8 16V	G4CN	1836	06/92>05/95	5075.88
1.9 D	XUD9	1905	09/97>07/00	5130.83
2.0 16V	G4GF	1975	06/97>07/00	6294.82
Matrix				
1.5 CRDi	D3-EA	1493	07/01>	6319.85
1.6	G4	1599	05/01>	6294.82
1.8	G4G	1795	05/01>	6294.82
Plaza				
2.5 TD	D4B	2476	02/00>	6840.82
Pony				
1.2	HYUN02	1238	01/82>10/86	5075.82
1.3	G4DGJA	1298	01/86>10/94	5075.82
	G4DGJE	1298	08/89>10/94	5075.88
	G4EH62	1341	07/94>	6293.82
1.4	HYUN04	1493	01/82>10/86	5075.82
1.5	G4DJJA / G4DJJE	1468	08/89>10/94	5075.88
	G4EK	1495	01/96>	6293.82
	HYUN01 / G4DJJA	1468	08/86>10/94	5075.82
Santa Fe				
2.0	G4DP	1997	08/00>	6870.82
2.0 CRDi	D4-EA	1991	12/00>	6319.85
2.4	G4X	2351	08/00>	6870.82
2.7	DELTA27	2656	08/00>	6297.82
Santamo NEW				
2.0	I4-DOHC / I4-SOHC	1997	07/98>	5075.88
Satellite				
2.4	G4CSS	2351	01/98>	5075.82
2.5 CRDI	D4CB	2497	02/02>	6840.82
2.5 TD	D4B	2476	07/00>	6840.82
Scoupe				
1.5	G4DJJA	1468	03/90>06/92	5075.82
	G4DJJE	1468	03/90>06/92	5075.88
	G4EK / G4EKET	1495	06/92>05/96	6580.88
Sonata				
1.8	G4CM	1795	07/93>07/98	5075.88
2.0	G4CP / G4CPD	1997	09/91>07/98	5075.88
	G4DP	1997	08/98>	6870.82
2.4	G4CS	2351	10/88>03/91	5075.88
	G4DS	2351	10/98>	6870.82
2.5	G6AV	2493	08/98>	6297.82
2.7	G6BA	2657	07/01>	6297.82
3.0	G6AT	2972	09/91>07/98	5075.88
Sonica				
2.0	G4DP	1997	09/98>	6870.82
2.5	G6AV	2493	09/98>	6297.82
Starex				
2.4	G4CSS	2351	01/98>	5075.82
2.5 CRDI	D4CB	2497	02/02>	6840.82
2.5 TD	D4B	2476	02/00>	6840.82





LISTE D'APPLICATIONS

APPLICATION LIST/ANWENDUNGSLISTE

VEHICULE MODEL FAHRZEUGTYP	MOTEUR ENGINE MOTOR	CYLINDRÉE ENGINE SIZE HUBRAUM	ANNÉE YEAR JAHR	VERNET
Stellar				
1.4	SATURN14	1439	12/83>04/86	5075.82
1.6	G32B	1597	12/83>01/92	5075.82
2.0	4G63	1997	05/84>12/89	5075.82
Terracan				
2.0 CRDi	D4-EA	1991	07/04>	6319.85
2.5 TD	D4BH	2476	05/01>	6840.82
2.9 CRDi	CRDI29	2902	07/01>03/04	6840.82
	CRDI29	2902	03/02>03/04	6580.88
3.5	6G74	3497	07/01>02/02	6297.82
Tiburon				
1.6	G4GRE	1599	01/02>	6294.82
2.0	G4GF	1975	01/02>	6294.82
2.7	G6BA-G	2656	01/02>	6297.82
	G6BA-G	2657	01/02>	6297.82
Trajet				
2.0	G4DP	1997	01/00>02/04	6870.82
	G4DP / E4	1997	03/04>	6294.82
2.0 CRDi	D4-EA	1991	05/01>	6319.85
2.7	DELTA27	2656	02/00>	6297.82
	DELTA27	2657	03/04>	6297.82
Tucson NEW				
2.0	G4GCG-141	1975	07/04>	6294.82
2.0 CRDi	D4-EA	1991	07/04>	6319.85
2.7	HYU27	2656	07/04>	6297.82
XG				
2.5	G6AV	2493	01/99>11/02	6297.82
3.0	6G72	2972	01/99>09/02	6297.82
3.5	G674	3497	09/02>	6297.82
Trooper				
3.1 TD	4JG2	3059	01/98>	6252.82

INNOCENTI

Elba				
1.3	146A5	1301	04/91>12/92	1519.82
1.4	146C5 / 146D5	1372	10/93>12/97	6541.82
1.5	149C1	1498	04/92>11/94	5071.85
1.6	146C6 / 146D6	1581	10/93>12/97	6541.82
1.7 D	146B2	1697	10/92>12/97	5687.80
Mille				
1.0	146C7	994	05/94>	1519.82
1.7 D	146B2	1697	05/95>	5687.80
Mini tre				
550 L	AB	548	10/87>01/93	3328.82
650 T	INNO5	617	04/86>10/89	3328.82
990 C / Turbo	CB / CB Turbo	993	04/82>02/91	3328.82
990 D	CL11	993	10/84>07/90	3328.82

JAGUAR

S-Type				
2.5	AJ-V6-2.5	2497	01/02>	6578.87
3.0	AJV6	2967	10/98>	6578.87
4.0	AJV8	3996	10/98>01/02	6578.87
4.2	AJ-V8-4.2	4196	01/02>	5753.84
Sovereign				
3.2	HPG	3239	09/94>	6246.88

PHOTOS PICTURES ZEICHNUNGEN	
	
1519	3328
	
5071	5075
	
5687	5753
	
6246	6252
	
6294	6297
	
6319	6541
	
6578	6580
	
6840	6870



LISTE D'APPLICATIONS

APPLICATION LIST/ANWENDUNGSLISTE









VEHICULE MODEL FAHRZEUGTYP	MOTEUR ENGINE MOTOR	CYLINDRÉE ENGINE SIZE HUBRAUM	ANNÉE YEAR JAHR	VERNET
...Sovereign				
4.0	JPF	3980	09/94>	6246.88
X-Type NEW				
2.0	AJ-V6-2.0	2099	02/02>	6960.82
2.0 D	X404	1998	09/03>	6312.88
2.5	AJ-V6-2.5	2495	02/01>	6960.82
3.0	AJ-V6-3.0	2967	02/01>	6960.82
XJ				
XJ 6 - 3.2	HPG	3239	09/94>10/02	6246.88
XJ 6 - 4.0	JPF	3980	09/94>10/02	6246.88
XJ 8 - 4.2	AJ-V8-4.2	4196	10/02>	5753.84
XJ 2 / XJ 6 - 3.2	HPG	3239	09/94>	6246.88
XJ 2 / XJ 6 - 4.0	JPF	3980	09/94>	6246.88
XJR / XJS				
3.6	DPMA	3590	11/88>09/89	6246.88
4.0	EPCM / KPD	3980	11/88>06/94	6246.88
5.3	HE	5345	09/93>04/91	1514.81
XK				
4.0 XK8	AJ-V8-4.0	3996	10/96>	5753.84
4.0 XKR	AJ-V8-4.0R	3996	03/98>	5753.84
4.2	AJ-V8-4.2	4196	02/04>	5753.84
JEEP				
Cherokee / Grand Cherokee				
2.1 TD	ENA / J8S	2068	01/93>	1535.80
	J8S.8.14 / 8.90	2068	09/77>12/92	1547.88
2.4	ED1	2429	01/01>	6843.91
2.5 CRD	ENJ	2499	01/01>12/01	5963.80
2.7 CRD	ENF	2688	01/03>	6847.87
3.7	EKG-211 / EKG-204	3700	01/01>	6845.88
4.0	JEEP01 / ERH	3964	09/77>07/00	1378.88
	RENA01 / 02	3988	06/88>01/93	6244.92
4.7	EVA / EVC	4701	08/00>05/05	6845.88
5.2	ELF	5210	01/93>	5812.92
Jeep				
2.0	J5R.8.00	1995	05/82>10/86	1533.88
2.1 TD	J8S.8.00	2068	05/82>10/86	4947.81
2.5	P	2464	03/89>01/93	6244.92
Wrangler				
2.5	EPE	2464	09/86>	1378.88
4.0	ERH	3964	09/90>	1378.88
4.2	6L	4235	01/86>08/90	1378.88
	ENF	4201	09/86>09/90	1378.88





LISTE D'APPLICATIONS

APPLICATION LIST/ANWENDUNGSLISTE

VEHICULE MODEL FAHRZEUGTYP	MOTEUR ENGINE MOTOR	CYLINDRÉE ENGINE SIZE HUBRAUM	ANNÉE YEAR JAHR	VERNET	PHOTOS PICTURES ZEICHNUNGEN
KIA					
Besta					
2.2 D	HW	2184	03/86>07/99	5980.88	 5075
Carens					
1.6	GA6D	1594	07/02>	5075.88	 5980
1.8 16V	T8	1793	12/99>07/02	5075.88	
2.0 CRDi	TCI	1991	07/02>	6319.85	
Carnival					
2.9 CRDi	J3	2902	01/99>01/02	6580.88	
Cerato NEW					
1.6	G4GD	1599	01/04>	6294.82	 6292
2.0 CRDi	D4DA	1991	01/04>	6319.85	 6294
2.0 CVVT	G4GC	1975	01/04>	6294.82	
Clarus					
1.8	T8	1793	03/95>07/01	5075.82	
2.0	FE-K9	1998	05/95>01/07	6292.88	 6297
Credos					
1.8 16V	T8	1793	01/97>	5075.82	 6319
K2700					
2.7 D	J2	2665	07/97>	6580.88	
Magentis					
2.0 16V	G4D	1997	02/01>	6870.82	
2.5 V6 24V	DELTA25	2493	02/01>	6297.82	 6484
Mentor					
1.5	B5	1498	06/96>	5075.82	 6580
1.6	B6	1598	05/94>01/97	5075.82	
Opirus NEW					
3.5	KIA01	3497	04/03>	6297.82	
	KIA01	3497	04/03>	6484.82	
Picanto NEW					
1.0	G4HF	999	01/04>	6484.82	
1.1	G4HG	1086	01/04>	6484.82	
Pregio					
2.7 D	J2	2665	11/95>	6580.88	 6870
Pride					
1.1	B1	1139	12/92>09/94	5075.82	
1.3	B3 / B3-EGI	1324	10/87>12/95	5075.82	
Retona					
2.0 16V 4WD	FE-DI	1998	09/99>06/00	6292.88	
	FE-DI	1998	06/00>	5075.88	
2.0 TCI 4WD	RF-TCI	1998	09/99>	5980.88	
Rio					
1.3	MI-TECH-SOH	1343	07/00>05/05	5075.88	
1.5	MI-TECH-SOH	1493	07/00>05/05	5075.88	
Sephia					
1.5	B5	1498	01/96>05/01	5075.82	
1.6	B6	1598	01/93>	5075.82	
1.8	T8D	1793	01/96>	5075.82	
Shuma					
1.5	B5-16V	1498	04/99>04/90	5075.82	
1.8	T8D	1793	09/98>	5075.82	
Sportage					
2.0	FE / DI	1998	10/00>09/02	5075.88	
2.0 4x4 16V	FE / FE-DI	1998	07/93>09/02	6292.88	
2.0 TD 4x4	RF	1998	06/96>09/02	5980.88	
2.2 D 4x4	HW	2184	07/93>09/02	6292.88	



LISTE D'APPLICATIONS

APPLICATION LIST/ANWENDUNGSLISTE

















VEHICULE MODEL FAHRZEUGTYP	MOTEUR ENGINE MOTOR	CYLINDRÉE ENGINE SIZE HUBRAUM	ANNÉE YEAR JAHR	VERNET
LADA				
110				
1.5	VAZ21083	1499	01/95>	6780.85
	VAZ2110 / 2111 / 2112	1499	01/95>	6780.85
111				
1.5	VAZ21083	1499	01/95>	6780.85
1200				
1.2	VAZ2101	1198	01/73>12/86	3720.80
1300				
1.3	VAZ2105	1294	01/76>	3720.80
1500				
1.5	VAZ21043	1451	01/74>	3720.80
1600				
1.6	VAZ2106	1568	08/78>10/83	3720.80
2105 Nova				
1.3		1294	05/81>	3720.80
2110				
2.1				6595.85
Moskvich / Aleko				
All models				6603.80
Natacha				
1.1	VAZ21081K	1117	05/93>12/97	3359.87
	VAZ21081K	1099	05/93>12/97	3359.87
1.5	VAZ21083K	1495	05/93>	3359.87
	VAZ21083K	1499	05/93>12/97	3359.87
Niva				
1.6	VAZ2121	1568	03/76>12/95	6596.80
1.6 4x4	VAZ2121	1568	03/76>	3359.87
1.7 4x4	VAZ21044	1690	09/94>	3720.80
1.9 D 4x4	XUD9L	1905	07/93>	5130.83
Others				6596.80
Sagona				
1.5	VAZ21083	1499	09/91>12/92	3359.87
1.5 D	TUD5	1527	07/95>	1542.89
Samara				
1.1	VAZ21081	1099	07/86>	3359.87
1.5	VAZ21083	1499	07/86>12/99	3359.87
1.5 D	TUD5	1527	03/95>	1542.89
1100	VAZ21081	1099	07/86>12/96	3359.87
1300	VAZ2108	1288	07/86>12/97	3359.87
Tavria				
All models				6597.87
Volga 3102 / 3110				
All models				6779.87
LANCIA				
Beta				
1.3	828B	1301	10/74>10/80	245F.79
1.4	828A2	1438	01/72>11/75	245F.79
1.6	828A / 828B	1585	10/73>	245F.79
1.8	828A1	1756	10/72>11/75	245F.79
1300	828	1366	07/81>12/85	245F.79
	828B3.000	1297	10/74>10/80	245F.79
1600	828AC	1585	10/73>12/85	245F.79
2.0	134A5 / 828B	1995	03/75>	245F.79





LISTE D'APPLICATIONS

















APPLICATION LIST/ANWENDUNGSLISTE

VEHICULE MODEL FAHRZEUGTYP	MOTEUR ENGINE MOTOR	CYLINDRÉE ENGINE SIZE HUBRAUM	ANNÉE YEAR JAHR	VERNET	PHOTOS PICTURES ZEICHNUNGEN
Dedra					
1.6	159B9 / 182A4	1581	07/94>09/99	6541.87	 1514
	835A1 / 835C1	1581	03/89>06/94	1538.88	 1538
	835C1	1581	03/89>06/94	6250.87	 5071
1.6 16V	182A4	1581	12/97>09/99	6590.88	 5074
1.8	835A2 / 835C5	1756	03/89>06/94	1538.88	 5688
1.8 16V	182A2	1747	03/96>09/99	6509.88	 5975
	183A1	1747	03/96>09/99	6490.83	 6250
1.9 TDS	160D1	1929	03/89>09/99	5975.80	 6253
	160D1	1929	03/89>09/99	6537.80	 6254
	835A4	1929	03/89>	5688.80	 6255
835A4	835A4	1929	10/95>09/99	6254.80	 6263
	835A4	1929	03/89>10/95	6263.80	 6490
1.9 TDS (A/C)	835A4	1929	10/95>09/99	6255.80	 6509
	835A4	1929	10/95>09/99	6255.80	 6537
2.0	835A	1995	03/89>09/99	1538.88	 6541
	835A	1995	03/89>09/99	1514.81	 6590
Delta					
1.1	831B8	1100	04/86>12/90	5071.85	
1.1 / 1.3	156B	999	09/79>05/86	6253.80	
1.3	831A / 831B	1301	09/79>08/99	5071.85	
1.4	160A1 / 836A4	1372	03/93>08/99	6250.87	
1.5	138B2	1498	09/79>05/86	5074.80	
	831A1 / 831B1	1498	09/79>05/93	5071.85	
1.6	182A6 / 835C1	1581	07/95>08/99	6250.87	



LISTE D'APPLICATIONS

















APPLICATION LIST/ANWENDUNGSLISTE

VEHICULE MODEL FAHRZEUGTYP	MOTEUR ENGINE MOTOR	CYLINDRÉE ENGINE SIZE HUBRAUM	ANNÉE YEAR JAHR	VERNET	PHOTOS PICTURES ZEICHUNGEN
...Delta					
1.6 16V	182A4	1581	07/95>08/99	6504.88	 1514
	182A4	1581	11/97>	6590.88	 1538
1.6 Turbo	831B. / 149C2	1585	10/82>07/93	1538.88	 5687
1.8	182A2	1747	07/97>08/99	6509.83	 5688
	835C / 836A	1756	03/93>08/99	1538.88	 5975
	836A5	1756	03/93>08/99	1538.88	 6254
1.8 16V	183A1	1747	05/96>08/99	6490.83	 6255
1.9 TD	160D1	1929	06/94>08/99	5975.80	 6263
	160D1	1929	06/94>08/99	6537.80	 6490
	831D1	1929	04/86>07/93	5687.80	 6504
	835A4	1929	04/95>09/95	5688.80	 6509
	835A4	1929	04/95>09/95	6263.80	 6537
	835A4	1929	10/95>08/99	6254.80	 6547
	835A4	1929	10/95>08/99	6255.80	 6559
2.0 Turbo	831C5	1995	09/87>07/88	1514.81	 6590
2.0 Turbo 4WD	831B5 / C5 / D5 / E5	1995	04/86>09/94	1538.88	 6839
Kappa					
2.0	175A3	1998	05/98>10/00	6839.88	
2.0 / 2.4	838A1 / A2 / A6	1995	10/94>10/01	6559.83	
2.0 20V	838B2	1995	07/96>	6547.88	
2.4 20V	838B2	2446	12/98>	6547.88	



LISTE D'APPLICATIONS













APPLICATION LIST/ANWENDUNGSLISTE

VEHICULE MODEL FAHRZEUGTYP	MOTEUR ENGINE MOTOR	CYLINDRÉE ENGINE SIZE HUBRAUM	ANNÉE YEAR JAHR	VERNET	PHOTOS PICTURES ZEICHUNGEN
...Kappa					
2.4 JTD	838A8	2387	05/98>	6489.88	 5130
	838A8	2387	06/98>	6576.88	 6332
Lybra					
1.6 16V	182A4 / 182B6	1581	09/99>	6590.88	 6489
1.8 16V	839A4 / 839A7	1747	09/99>	6506.88	 6506
1.9 JTD	937A2 / AR37101	1910	09/99>	6826.88	 6547
	AR32302	1910	09/99>	6551.88	 6551
2.0	185A8	1998	09/99>	6834.88	 6576
2.0 20V	182B7	1998	09/99>	6547.88	 6590
2.4 JTD	839A6	2387	12/00>	6825.88	 6782
	839A6 / 841C	2387	09/99>02/01	6871.88	 6825
	AR32501 / 839A5	2387	09/99>	6551.88	 6826
Musa NEW					
1.3 JTD	188A9.000	1248	07/04>	6835.88	 6834
1.4	843A1.000	1368	07/04>	6782.87	 6826
1.9 JTD	188B2.000	1910	04/07>	6877.88	 6835
Phedra					
2.0	EW10	1997	09/02>	6332.89	 6871
2.0 JTD 16V	DW10 / RHW	1997	09/02>	5130.83	 6877
2.2 JTD	DW12	2179	09/02>	5130.83	 CT1743
2.2 JTD 16V	4HW	2197	09/02>	5130.83	
3.0	ES9	2946	09/02>	CT1743.82	



LISTE D'APPLICATIONS

APPLICATION LIST/ANWENDUNGSLISTE

VEHICULE MODEL FAHRZEUGTYP	MOTEUR ENGINE MOTOR	CYLINDRÉE ENGINE SIZE HUBRAUM	ANNÉE YEAR JAHR	VERNET	PHOTOS PICTURES ZEICHNUNGEN
Prisma					
1.3	831B	1301	01/83>05/86	5071.85	 245F  1514
	831B	1301	01/83>04/89	6253.80	
1.5	831B	1498	01/83>05/86	5071.85	 1538  3309
	831B1	1498	04/83>05/86	5074.80	
1.6	831B6	1585	04/83>05/86	245F.79	 5069  5071
	831B6 / 831B7	1585	06/86>04/89	1538.88	
1.9 D	149A1	1929	06/84>04/89	5687.80	 5074  5687
1.9 TD	831D1	1929	05/85>05/87	5687.80	
2.0 4WD	828B1	1995	04/86>04/89	1538.88	 5700  6253
Thema					
2.0	834B / 834C	1995	10/84>11/94	1514.81	 6564  6782
2.4 TD	8144-81	2445	10/84>09/92	5700.82	
2.4 TD	8144-81	2445	05/87>09/88	5071.85	 6825  6834
	2.5 TD / TDS	8144-97	2500	10/88>11/94	
2.5 TDS	8144-97	2500	09/88>08/92	3309.79	 6835  6882
Thesis					
2..0	841E	1998	09/02>	6834.88	 6825  6834  6835  6882
2.4	841D	2446	09/02>	6834.88	
2.4 JTD	841C	2387	09/02>	6825.88	
	841G	2387	09/02>	6882.88	
Y10					
1.0	156A2	999	01/89>09/92	5069.87	 6825  6834  6835  6882
1.1	156C / 176B2	1108	01/89>10/95	5069.87	
1.3	146A5	1297	09/92>10/95	6564.80	
	156B	1301	01/89>09/92	6564.80	
Ypsilon					
1.1	176B2	1108	04/97>	5069.87	 6825  6834  6835  6882
1.2	188A5	1242	09/00>	6782.87	
1.2 16V	176B9 / 188A / 840A3	1242	11/95>09/03	5069.87	
1.3	188A9	1248	10/03>	6835.88	



LISTE D'APPLICATIONS

APPLICATION LIST/ANWENDUNGSLISTE

VEHICULE MODEL FAHRZEUGTYP	MOTEUR ENGINE MOTOR	CYLINDRÉE ENGINE SIZE HUBRAUM	ANNÉE YEAR JAHR	VERNET
----------------------------------	---------------------------	-------------------------------------	-----------------------	--------

PHOTOS
PICTURES
ZEICHUNGEN

...Ypsilon

1.4	840A2 / 840A4	1370	11/95>	6557.88
-----	---------------	------	--------	----------------

Ypsilon II

1.2	188A4	1242	10/03>	5069.87
-----	-------	------	--------	----------------

	188A5	1242	10/03>	6782.87
--	-------	------	--------	----------------

1.3 JTD	188A9	1351	10/03>	6835.88
---------	-------	------	--------	----------------

1.4	843A1	1368	10/03>	6782.87
-----	-------	------	--------	----------------

Zeta

2.0	EW10	1997	01/01>08/02	6332.89
-----	------	------	-------------	----------------

	RFV	1998	07/98>12/00	4885.83
--	-----	------	-------------	----------------

2.0 JTD	DW10ATED / L4	1997	01/00>	5130.83
---------	---------------	------	--------	----------------

2.0 Turbo	RGX	1998	10/94>	5108.89
-----------	-----	------	--------	----------------

2.1 TD	P8C	2088	03/96>	5130.83
--------	-----	------	--------	----------------

LAND ROVER

Defender

2.5	17H	2494	10/90>	6510.74
-----	-----	------	--------	----------------

	17H	2494	10/90>	6510.82
--	-----	------	--------	----------------

2.5 D	12J	2495	10/90>	6510.74
-------	-----	------	--------	----------------

	12J	2495	10/90>	6510.82
--	-----	------	--------	----------------

2.5 TD5	LANDRO2	2495	06/98>	6880.00
---------	---------	------	--------	----------------

2.5 TDi	11L / 23L	2494	10/90>09/94	6511.88
---------	-----------	------	-------------	----------------

	16L	2494	10/94>	6511.88
--	-----	------	--------	----------------

3.5 V8	20G	3532	10/90>	6510.82
--------	-----	------	--------	----------------

4.0	36D	3947	11/98>	6510.88
-----	-----	------	--------	----------------

Discovery

2.0	20T4HG	1994	06/93>06/94	1419.88
-----	--------	------	-------------	----------------

	20T4HG	1994	06/93>06/97	1427.88
--	--------	------	-------------	----------------

2.5 TD5	LANDRO1	2496	11/98>11/04	6880.00
---------	---------	------	-------------	----------------

2.5 TDi	12L	2495	09/89>03/94	1419.88
---------	-----	------	-------------	----------------

	17L / 19L	2495	09/89>08/98	6511.88
--	-----------	------	-------------	----------------

3.5	27G	3528	09/89>08/93	6510.88
-----	-----	------	-------------	----------------

3.5 V8	22D / 24D / 27G	3532	09/89>08/93	6510.88
--------	-----------------	------	-------------	----------------

3.9	35D	3950	07/97>11/98	6510.88
-----	-----	------	-------------	----------------

3.9 V8	36D	3947	09/93>09/94	6510.88
--------	-----	------	-------------	----------------

4.0	35D	3950	11/98>	6880.00
-----	-----	------	--------	----------------

Freelander

1.8	18K4	1795	10/98>09/03	5955.88
-----	------	------	-------------	----------------

2.0 D	20L4D	1994	10/97>09/00	6880.00
-------	-------	------	-------------	----------------



1419

1427



4885

5069



5108

5130



5955

6332



6510

6511

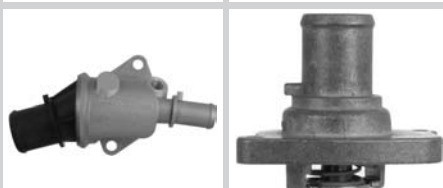

6557

6782



6835

6880



LISTE D'APPLICATIONS

APPLICATION LIST/ANWENDUNGSLISTE

Thermostats

Land Rover

VEHICULE MODEL FAHRZEUGTYP	MOTEUR ENGINE MOTOR	CYLINDRÉE ENGINE SIZE HUBRAUM	ANNÉE YEAR JAHR	VERNET
...Freelander				
2.0 TD4	M47-109 / M47-112	1951	09/00>	6952.88
2.0 TDi	20T2N	1994	10/97>	6880.00
Land 90				
2.3	11H	2286	06/84>12/87	6510.74
	11H	2286	06/84>12/87	6510.82
2.5		2500	09/85>09/90	6510.74
		2500	09/85>09/90	6510.82
2.5 D	12J	2495	07/84>09/90	6510.74
	12J	2495	07/84>09/90	6510.82
2.5 TD	12J	2495	09/86>09/90	6510.74
	12J	2495	09/86>09/90	6510.82
3.5 V8	15G	3528	06/84>09/90	6510.82
Land 109				
2.6	22*	2625	10/71>10/79	6510.78
	27G	3532	10/71>10/79	6510.78
3.5 V8	15G	3528	11/79>10/83	6510.82
	15G	3528	11/79>10/83	6510.88
Land 110				
2.3	11H	2286	10/83>10/87	6510.74
	11H	2286	10/83>10/87	6510.82
2.3 D		2386	10/83>10/87	6510.82
2.5		2500	09/86>09/90	6510.74
		2500	09/86>09/90	6510.82
2.5 D	12J	2495	07/84>09/90	6510.82
2.5 TD	12J	2495	09/86>09/90	6510.74
	12J	2495	09/86>09/90	6510.82
3.5 V8	15G	3528	10/83>09/90	6510.82
Range Rover				
2.5 TD	25 / 6TM	2497	09/94>	5973.80
	95A	2500	10/89>10/92	5963.80
2.5 TDi	14L	2495	11/92>09/94	5963.80
3.5 V8	15G	3528	07/81>09/86	6510.74
	15G	3528	07/81>09/86	6510.88
	15G	3528	07/81>09/86	6510.82
	25D / 24D / 29D	3532	09/86>10/89	6510.88
3.9	35D	3950	10/89>09/94	6510.88
3.9 V8	35D / 36D / 37D	3947	10/89>09/94	6510.88
4.2 V8	40D	4278	10/92>09/94	6510.88
4.4	M62B44	4398	03/00>	6493.105

LEXUS

LS400 **NEW**

4.0	1UZ-FE	3969	07/97>08/00	6583.82
	1UZ-FE	3969	12/89>07/97	6295.82

LS430 **NEW**

4.3	3UZ-FE	4293	08/00>	6583.82
-----	--------	------	--------	----------------

RX300

3.0	1MZ-FE	2995	10/00>02/03	6295.82
-----	--------	------	-------------	----------------

SC430 **NEW**

4.3	3UZ-FE	4293	05/01>	6583.82
-----	--------	------	--------	----------------



5963



5973



6295



6493



6510



6583



6880



6952

NEW



LISTE D'APPLICATIONS

APPLICATION LIST/ANWENDUNGSLISTE

VEHICULE MODEL FAHRZEUGTYP	MOTEUR ENGINE MOTOR	CYLINDRÉE ENGINE SIZE HUBRAUM	ANNÉE YEAR JAHR	VERNET
MAZDA				
121 / Festiva				
1.1	B1-15	1139	01/88>10/90	5075.82
	B1-15 / B1-21	1139	11/90>10/93	5075.88
	B1-16	1139	01/88>10/90	6292.88
1.2	DHA	1242	03/96>	6844.82
1.3	B3-A5 / B3-B1	1324	01/88>	5075.88
	B3-A5 / B3-B1	1324	01/88>10/90	5075.82
	B3-A6	1324	01/88>10/90	6292.88
	B3-C9	1324	11/90>02/96	5075.88
	B3-D1 / D2 / D3	1324	11/90>02/96	5075.88
	J4C / JJA	1299	03/96>	6244.92
1.8	VC	1769	10/75>12/79	5075.82
	VC	1769	10/75>12/79	6292.88
1.8 D	RTK	1753	03/96>	6526.88
2.0	MA	1970	03/77>12/79	5075.82
	MA	1970	03/77>12/79	6292.88
323				
1.0	PC	985	10/70>12/76	1416.82
	PC	985	12/76>04/78	5075.82
	PC	985	04/78>05/81	5075.88
1.1	E1	1071	08/80>08/87	5075.88
1.3	B3-84	1324	09/87>12/89	5075.88
	B3-84 / 85 / 86 / 87	1324	06/89>	5075.82
	B3-C9	1324	06/94>07/95	5075.82
	B3-C9	1324	06/94>09/96	6292.88
	E3-91 / E3-93	1296	08/80>12/87	5075.88
	TC	1272	12/76>04/78	5075.82
	TC	1272	04/78>05/81	5075.88
1.3 16V	B3-BJ / B3-C9 / -ME	1324	06/94>	6292.88
1.4	UC	1415	05/78>05/81	5075.88
1.5	B5	1498	09/87>12/89	5075.88
	B5-05 / B5-05C	1498	01/86>08/93	5075.82
	E5 / E5-H5 / E5-J9	1490	08/80>12/87	5075.88
	E5-K4	1490	01/86>08/86	6292.88
	Z5	1489	06/94>07/95	5076.82
	Z5	1489	08/95>06/98	5076.88
	Z5	1498	06/94>07/95	6292.88
	ZL	1498	08/98>09/00	5076.88
1.6	B6 / B6-5M / B61	1598	07/89>05/94	5075.82
	B6-82 / 88 / 89	1598	06/86>06/87	6292.88
	B6-DA	1598	02/97>06/98	5076.82
	B6-DA	1598	02/97>06/98	5076.88
1.6 4x4	B6 / B6T / ZM-3	1598	07/85>10/03	5075.88
1.7 D	PN / PN-27 / PN-54	1720	09/86>	1419.82
1.7 TD	4EE1	1686	11/94>09/96	6252.85
1.8	BP-ZE	1840	08/94>09/96	6292.88
	BP-ZE	1840	10/94>07/95	5075.88
	BP-ZE	1840	07/95>09/96	5076.82
	BP-ZE	1840	08/95>06/98	5076.88
	MAZDA01	1840	08/89>	5075.82
	1.8 16V	FP-18	1840	08/98>09/00
1.8 Turbo 4WD	BP / BPT / BP-TH	1840	08/89>	5075.82
2.0	FS-7	1991	10/00>10/03	6702.82
2.0 D	RF-1G	1998	03/97>06/98	6702.82
2.0 Di	RF-ID	1998	08/98>09/00	6702.82

PHOTOS PICTURES ZEICHNUNGEN	
 1416	 1419
 5075	 5076
 6244	 6252
 6292	 6526
 6702	 6844



LISTE D'APPLICATIONS

APPLICATION LIST/ANWENDUNGSLISTE

VEHICULE MODEL FAHRZEUGTYP	MOTEUR ENGINE MOTOR	CYLINDRÉE ENGINE SIZE HUBRAUM	ANNÉE YEAR JAHR	VERNET
...323				
2.0 DiTD	RFT	1998	08/98>10/03	6702.82
2.0 V6	KF	1995	10/94>09/96	6702.82
616				
1.6	NA	1586	09/73>08/75	5075.82
	NA	1586	09/73>08/75	6292.88
626				
1.6	F6-83	1587	10/87>01/92	5075.88
	NA	1586	10/74>09/78	1416.82
	NA	1586	10/78>10/83	5075.82
	NA	1586	10/78>	6292.88
1.8	F8-K8 / F8-K9	1789	10/87>01/92	5075.88
	VC	1769	10/78>10/82	5075.82
	VC	1769	10/78>10/82	6292.88
1.8 16V	FP-01 / FP16	1840	08/91>	6702.82
2.0	FE / FE-EGI	1998	11/82>12/87	5075.88
	FE-90 / FJ / FK	1998	10/87>02/92	5075.88
	FE-Y8	1998	03/92>10/97	5075.88
	MA	1970	10/78>10/83	5075.82
	MA	1970	10/78>	6292.88
2.0 16V	FE-KD	1998	03/92>10/97	6292.88
	FS-115 / FS-136	1991	06/97>05/02	6702.82
	FS-31 / FS-83 / FS-84	1991	09/91>	6702.82
2.0 16V 4WD	FE-FL / FE-FN	1998	10/87>01/92	6292.88
	FE-FN / FE-GA / GB	1998	10/88>02/92	5075.88
2.0 D	RF	1998	03/84>	5971.88
	RF-D1	1998	10/87>	5980.88
	RF-G5	1998	03/92>05/95	6292.88
	RF-G5 / RF-H7	1998	03/92>05/95	5980.88
2.0 DiTD 16V	RFT-DI-90 / 100 / 110	1998	07/98>05/00	6702.82
2.2	F2-G2 / G3 / G4	2184	10/88>02/92	6292.88
2.2 4WD	F2-G6 / G7	2184	08/89>10/97	6292.88
	F2-L1 / M2 / Y4	2184	09/90>10/97	6292.88
2.2 D	F2-M2	2184	03/92>	6292.88
2.5	KL-22	2497	09/91>05/97	6702.82
2.5 4WD	KL-21	2497	09/91>	6702.82
929				
1.8	VC	1769	04/73>08/81	5075.82
	VC	1769	04/73>08/81	6292.88
2.0	FE	1998	10/84>12/87	5075.88
	FE / FE-EGI	1998	10/84>08/86	5075.82
	MA	1970	07/78>08/86	5075.82
	MA	1970	07/78>08/81	6292.88
	MA	1970	10/81>08/86	1416.82
2.2	F2	2184	09/86>12/92	5075.88
2.2 D	S2D	2184	08/80>08/81	5075.82
	S2D	2184	08/80>08/81	6292.88
2.6	12A / LA42S-P	2616	03/79>08/81	6319.82
3.0	JE	2984	10/87>	5075.88
B Pick-up				
1.6	F6-91	1587	11/89>	5075.88
1.8	VC	1769	10/75>12/79	6292.88
2.0	FE-CL	1998	11/89>	5075.88
	MA	1970	10/75>12/79	6292.88
2.2	F2-L8	2184	08/91>	5075.88



1416



5075



5971



5980



6292



6319





6702



LISTE D'APPLICATIONS

APPLICATION LIST/ANWENDUNGSLISTE

VEHICULE MODEL FAHRZEUGTYP	MOTEUR ENGINE MOTOR	CYLINDRÉE ENGINE SIZE HUBRAUM	ANNÉE YEAR JAHR	VERNET	PHOTOS PICTURES ZEICHUNGEN
...B Pick-up					
2.2 D	R2-G3 / R2-G4	2184	11/89>01/99	5980.88	
2.6	G6-MPV	2606	08/91>01/99	6292.88	
2.6 4WD	G6-12	2555	11/89>	6292.88	
Demio					
1.3	B3-2E / B3-EL / B3-EN	1324	05/98>03/03	5075.88	
E					
1.3	TC	1272	03/81>12/83	5075.88	
1.4	UC	1415	03/81>12/87	5075.88	
1.6	NA	1586	03/81>03/84	5075.88	
2.0	FE-BN / CK / EP	1998	12/87>04/97	5075.88	
2.2 D 4WD	R2 / R2-TV	2184	03/81>04/91	5980.88	
Mazda 2					
1.2	DHC	1242	03/03>	6844.82	
1.4	ZH14	1388	03/03>	6844.82	
1.4 MZ-CD	MZ14CD	1399	03/03>	6874.83	
1.6	DURA16	1596	03/03>	6844.82	
Mazda 3					
1.4	MZR14	1349	06/03>	6702.82	
	ZH14	1388	03/04>	6844.82	
1.6	DURA16	1596	07/04>	6844.82	
	MZR16	1598	11/03>	6702.82	
1.6 MZ-CD / DE	MZ16CD / FAP	1560	07/04>	6875.83	
Mazda 5 NEW					
2.0	MZR-CD	1999	09/05>	6702.82	
Mazda 6					
2.0 DiTD	RF-136	1998	06/02>	6702.82	
2.0 MZR-CD	MZR-CD120	1998	06/02>	6702.82	
2.3	L3	2261	10/04>	6702.82	
MPV					
2.0	FS-D	1991	06/99>07/02	6702.82	
2.0 DiTD	RF-136	1998	03/02>	6702.82	
2.5 TD	WL-01	2499	12/95>10/99	6702.82	
3.0	JE-96	2954	06/96>10/99	6702.78	
3.0 V6	JE-96	2954	06/96>10/99	6702.82	
MX3					
1.6	B6-9J	1598	08/91>	5075.88	
	B6-9J / B6-9K	1598	03/91>01/94	6292.88	
1.6 16V	B6-16V	1598	01/94>	6292.88	
1.8 V6	K8-19	1845	08/91>	5075.88	
	K8-19	1845	03/91>	6702.82	
MX5 "Miata"					
1.6	B6-4J	1598	03/98>08/00	5076.88	
	B6-9J / B6-ZE	1598	04/90>02/98	6292.88	
1.6 16V	B6-4J	1598	09/00>	5075.88	
1.8	BP-F1	1840	09/93>02/98	6292.88	
	BP-ZE	1840	03/98>08/00	5076.88	
1.8 16V	BP-5C	1840	09/00>	5075.88	
2.0	FS-19	1991	09/05>	6702.82	
MX6					
2.0	FS-19	1991	07/91>08/97	6702.82	
2.5 4WD	KL-19 / KL-20	2497	07/91>08/97	6702.82	
Premacy					
1.8	FP / FP-18 / FP-E1	1840	06/99>07/01	6702.82	
2.0	FS-7E / FS-7G	1991	07/01>	6702.82	



5075



5076



5980



6292



6702



6844



6874



6875



LISTE D'APPLICATIONS

APPLICATION LIST/ANWENDUNGSLISTE

VEHICULE MODEL FAHRZEUGTYP	MOTEUR ENGINE MOTOR	CYLINDRÉE ENGINE SIZE HUBRAUM	ANNÉE YEAR JAHR	VERNET
...Premacy				
2.0 DiTD	RF-4F / RFT	1998	06/99>	6702.82
RX5				
2.6	12A / 13B	2616	10/75>12/79	6319.82
	CD22C / C-T	2616	10/75>12/79	6319.82
	CD23C / C-T	2616	10/75>12/79	6319.82
RX7				
2.6	12A / 13B	2616	03/78>12/91	6319.82
	13BREW	2616	10/91>12/96	6319.82
	FC1322 / 1332 / 1832	2616	09/85>12/91	6319.82
	SA22C2 / FB1312	2616	03/78>12/86	6319.82
2.6 Turbo	FD1332	2616	10/91>	6319.82
RX8 NEW				
1.3	13B-MSP	1308	02/03>	6948.82
Tribute				
2.0	YF	1989	01/00>	5750.92
Xedos 6 / Xedos 9				
2.0	K8-ZE20	1995	08/92>	5075.88
2.0 V6	K8-ZE20	1995	10/91>	6702.82
2.3	KJ-ZEM	2225	10/93>	6702.82
2.5	K8-ZE25	2497	10/93>	5075.88
2.5 4WD	K8-ZE25	2497	10/93>	6702.82

MAZDA



Transporter

2.0	1998	01/84>	5075.82
2.2 D	2184	01/85>	5971.88

MERCEDES

Série 123

2.0 (123) - 200	115.938 / .939	1988	01/76>07/80	1476.87
2.0 (123) - 200 / 200T	102.920 / .939	1997	01/76>12/85	1476.87
2.0 (123) / 2.0 D - 200D	615.940	1998	01/76>12/85	1535.80
2.2 D - 220D	615.941	2197	01/76>09/79	1535.80
2.3 (123) - 230 / 230C / 230CE / 230E / 230T / 230TE	102.980 / 115.954	2299	01/76>07/85	1476.87
2.3 (123)	115.954	2307	03/77>02/81	1476.87
2.4 D (123) - 240 D / 240 DL	616.912	2404	01/76>12/85	1535.80
2.4 TD - 240TD / 240T TD	616.912	2404	01/76>09/85	1535.80
2.5 (123) - 250 / 250L / 250T	123.920 / .921	2525	01/76>12/85	1476.87
2.7 - 280 / 280TE	123.920 / .921	2746	01/76>09/85	1476.87
2.7 - 280 / 280C / 280CE / 280E / 280EL / 280TE	110.923 / .984 / .988	2746	01/76>09/85	1476.87
2.7 (123)	11.984 / .988 / .923	2749	03/77>07/85	1476.87
3.0 TD (123) - 300 TD / 300 D TD / 300T TD	617.952	2998	08/79>12/1985	1535.80
3.0 D (123) - 300 D / 300 DL / 300T D	617.912	3005	01/76>12/85	1535.80

Série 124

2.0 (124) - 200 / 200CE / 200E / 200T / 200TE	102.922 / .963	1997	12/84>12/92	1476.87
2.0 D (124) - 200D / 200T D	601.912	1997	12/84>06/93	5699.85
2.0 (124)	111.940	1997	09/89>06/93	6285.87
2.0 - 200 / 200CE / 200E / 200T / 200TE	111.940 / .960	1998	09/89>06/93	6285.87
2.2 (124) - 220CE / 200E / 220TE	111.960	2199	10/92>06/93	6285.87



1476



1535



5075



5699



5750



5971



6285



6319



6702









6948

NEW



LISTE D'APPLICATIONS

APPLICATION LIST/ANWENDUNGSLISTE

VEHICULE MODEL FAHRZEUGTYP	MOTEUR ENGINE MOTOR	CYLINDRÉE ENGINE SIZE HUBRAUM	ANNÉE YEAR JAHR	VERNET	PHOTOS PICTURES ZEICHNUNGEN
...Série 124					
2.3 (124) - 230CE / 230E / 230TE	102.982	2299	12/84>12/92	1476.87	 1476
2.5 TD (124) - 250TD / 250T TD	602.962	2497	09/88>06/93	5699.80	 5699
2.5 D (124) - 250D / 250DL / 250T D	602.912	2497	12/84>06/93	5699.85	
2.6 (124) - 260E	103.940 / .943	2599	01/85>09/92	1476.87	
2.8 - 280E / 280EL / 280TE	104.942	2799	10/92>06/93	1476.87	
3.0 - 300CE / 300E / 300TE	103.980 / .983 / .985	2962	03/85>06/93	1476.87	
3.0 24V (124) - 300CE / 300E / 300TE	104.980	2962	07/89>06/93	1476.87	
3.0 TD (124) - 300TD / 300T TD	603.960 / .963	2996	03/86>06/93	5699.80	 5963
3.0 D (124) - 300D / 300T D	603.912 / .913	2996	12/84>06/93	5699.85	 6247
3.2 (124) - 320CE / 320E / 320TE	104.992	3199	10/92>06/93	1476.87	
4.2 (124) - 400E	119.975	4196	10/92>06/93	6543.80	
4.2 - 400E	119.975	4196	10/92>06/93	6849.80	
5.0 (124) - 500E	119.974	4973	06/90>	6543.80	
5.0 - 500E	119.974	4973	06/90>06/93	6849.80	
190					
1.8 (W201) - E	102.910 / .919	1797	03/90>03/93	1476.87	
2.0 (W201) - E	102.921 / .938 102.921 / .924 / .961 / .938	1997	12/82>08/89	5963.92	 6285
	102.962	1997	09/85>08/93	1476.87	 6514
2.0 D(W201)	601.911	1997	12/83>08/93	5699.85	
2.3 (W201) - E 16S	102.983 / .985	2299	08/84>07/93	1476.87	
2.5 (W201) - E 16S	102.990 / .991	2498	09/88>03/93	1476.87	
2.5 D (W201)	602.691 / .911 602.961	2497	01/85>07/93	5699.85	 6515
	602.961	2497	07/86>07/93	5699.80	 6543
2.6 (W201) - E	103.942	2599	01/87>07/93	1476.87	
V8 3.5 / 4.5 / 5.0	All Motors		09/73>08/81	6544.75	
Class A					
1.4 (W168) - A140	166.940	1397	05/97>01/05	6514.87	
1.6 (W168) - A160	166.960	1598	05/97>03/01	6514.87	
1.7 CDI (W168) - A160 / A170	668.940 / .941	1689	05/98>03/01	6515.87	
1.9 (W168) - A190	166.990	1898	04/99>03/01	6514.87	
2.1 (W168) - A210	166.995	2084	01/02>	6514.87	
Class A II / Class B NEW					
1.5 (W169 / W245) - 150	266.920	1498	07/04>	6991.00	
1.7 (W169 / W245) - 170	266.940	1699	07/04>	6991.00	
1.9 CDI (W169) - 160 CDI	640.942	1991	07/04>	6992.00	
2.0 (W169 / W245) - 200 / 200 Turbo	266.960 / 266.980	2034	07/04>	6991.00	
2.0 CDI / 2.0 D (W169 / W245) - 180 CDI	640.940	1991	07/04>	6992.00	
2.0 CDI / 2.0 D (W169 / W245) - 200 CDI	640.941	1991	07/04>	6992.00	
Class C					
1.8 (203) - C180 / C200 / C230	271.940/271.946/271.948	1796	06/02>	6962.90	
1.8 CGI (203) - C200 CGI	271.942	1796	06/02>	6962.90	
1.8 (202) - C 180 / C 180T	111.920 / .921 111.920 / .921	1799	03/93>02/01	6247.87	
		1799	03/93>02/01	6285.87	
1.8 CGi (203) - C200 CGI / C220 CGI	271.942		01/04>	6962.90	
2.0 D (202) - C 200D / C200T D	601.913 / .915 / 604.915	1997	03/93>	5699.85	
2.2 CDI (202)	601-913	1997	03/93>02/00	5699.85	
2.0 (202) - C 200 / C 200K / C 200T	111.941 / .945	1998	01/94>	6247.87	
2.0 (202) - C 180	111.952	1998	04/00>	6285.87	
2.0 (202) - C 200 / C 200T	111.941 / .944 / .945 / .956	1998	01/94>	6285.87	
2.0 (203) - C180 / C200	111.195/111.955	1998	04/00>	6954.87	
2.1 (203) - C 220 CDI	611.962	2148	04/00>	6884.92	



1476



5699



5963



6247



6285



6514



6515



6543



6544



6849



6884



6954

NEW



6962

NEW



6991

NEW



6992

NEW



LISTE D'APPLICATIONS

APPLICATION LIST/ANWENDUNGSLISTE

VEHICULE MODEL FAHRZEUGTYP	MOTEUR ENGINE MOTOR	CYLINDRÉE ENGINE SIZE HUBRAUM	ANNÉE YEAR JAHR	VERNET
...Class C				
2.7 (203) - C 270 CDI	611.962	2148	08/00>12/03	6884.92
2.1 CDI (203)	611.962	2148	01/03>	6884.92
2.2 CDI (202)	611-960/-960A	2151	07/98>02/01	6920.87
2.2 D (202) - C 220D / C 220T D	604.910	2155	08/93>	5699.85
2.2 (202) - C 220	111.961	2199	03/93>	6247.87
	111.961	2199	03/93>	6285.87
2.3 (202) - C 230 / C 230T	111.974	2295	08/95>	6247.87
2.3 (202) - C 230 / C 230K	111.975	2295	09/95>	6285.87
2.3 (203) - C200	111.981	2295	09/00>12/03	6954.87
2.4 (202) - C 240 / C 240T V6	112.910	2398	06/97>	6513.87
2.5 TD (202) - C 250TD / C 250T TD	605.960	2497	09/95>	5699.80
2.5 D (202) - C 250 D	605.910	2497	05/93>	5699.85
2.7 CDI (203)	912-962	2585	01/03>	6846.92
	612-962	2585	08/00>07/05	6884.92
2.6 (203) - C 240 V6	112.912 / .915 / .916	2597	04/00>	6513.87
2.6 (203) - C 260 V6	112.912	2597	03/01>	6513.87
2.6 (203)	112.912 / .916	2597	04/00>09/02	6513.87
2.7 (203) - C 270 CDI	612.962	2685	03/01>	6846.87
2.8 (202) - C 280	104.941	2799	05/93>	1476.87
2.8 (202) - C 280 / C 280T	112.920	2799	05/93>	6513.87
3.2 (203) - C 320 V6	112.946 / .953	3199	04/00>	6513.87
3.2 (203) - C32AMG	112.961	3199	09/00>	6974.87
3.5 (107)	116982/984	3499	10/71>02/80	6544.75
3.6 (202) - C 36 AMG	C36AMG	3606	09/94>	1476.87
3.6 (202)	C36AMG	3606	09/94>02/00	6920.87
4.3 (202) - C 43 AMG / V8	113.944	4266	10/97>	6513.87
5.5 (203)	113-988	5439	01/04>	6513.87
Class CL NEW				
5.0 (215) - 500	113.960	4966	08/99>	6513.87
5.4 (215) - 55 AMG	113.986	5439	09/99>	6513.87
Class CLS NEW				
5.0 (219) - 500	113.967	4966	07/04>	6513.87
Class E				
1.8 (211) - E200	271.941	1796	09/02>	6962.90
2.0 D (124) - E 200D	601.912	1997	07/93>09/95	5699.85
2.0 D (210) - E 200D	604.917	1998	04/95>06/99	5699.85
2.0 (210) - E200 / E 200 T	111.942	1998	04/95>	6247.87
2.0 (124) - E 200 / E 200T	111.940	1998	07/93>	6285.87
2.0 (210) - E200 / E 200 L	111.947 / .957	1998	04/95>	6285.87
2.0 (210)	111-947	1998	06/99>03/02	6513.87
2.1 CDI (210) - E 200 CDI / E 220 CDI	611.961	2148	03/96>	6846.87
	611.961	2148	03/96>	6846.92
2.1 CDI (211) - E 200 16V / E 220 / E 220 16V	646.951/-961	2148	03/02>	6847.92

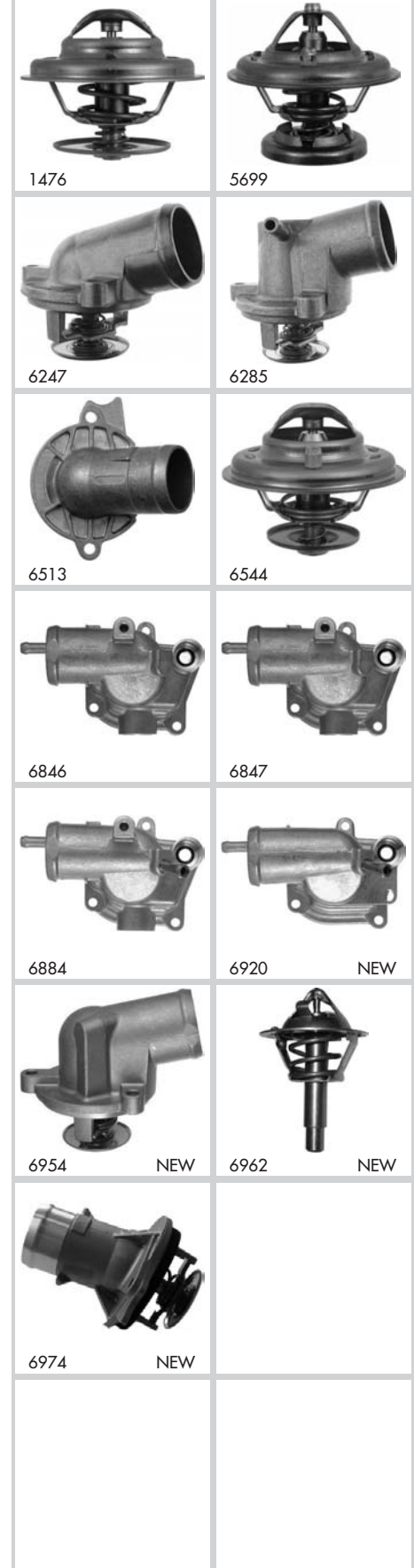



LISTE D'APPLICATIONS









APPLICATION LIST/ANWENDUNGSLISTE

VEHICULE MODEL FAHRZEUGTYP	MOTEUR ENGINE MOTOR	CYLINDRÉE ENGINE SIZE HUBRAUM	ANNÉE YEAR JAHR	VERNET	PHOTOS PICTURES ZEICHNUNGEN
...Class E					
2.1 CDI (210) - E 200 CDI / E 220 CDI	611.961	2148	03/96>	6848.87	 1476  5699
	611.961	2148	03/96>	6884.87	
	611.961	2148	03/96>	6884.92	
2.2 D (210) - E 220D	604.912	2155	04/95>06/99	5699.85	 6247  6285
2.2 (124) - E 220 / E 220T	111.960	2199	07/93>	6285.87	
2.3 (210) - E 230 / E 230T	111.970	2295	04/95>	6247.87	 6513  6543
	111.970	2295	04/95>	6285.87	
2.4 (210) - E 240 / E 240T	112.911	2398	04/95>	6513.87	 6846  6847
2.5 TD (124) - E 250 TD / E 250T TD	602.962	2497	07/93>02/96	5699.80	
2.5 TD (210) - E 250 TD	605.962	2497	04/95>06/99	5699.80	 6848  6849
2.5 D (124) - E 250D / E 250D L / E 250T D	605.911	2497	07/93>02/96	5699.85	
2.5 D (210) - E 250 D / E 250 DL / E 250 TD	605.912	2497	04/95>	5699.85	 6884  6953 NEW
2.5 TD (210) - E 250 TD	605.962	2497	03/96>06/99	5699.85	
3.0 TD (210) - E 300 TD / E 300T TD	602.962	2497	04/95>	5699.85	 6953 NEW
2.6 (210) - E 240 / E 240 T / E 280	112.914	2597	06/99>	6513.87	
2.6 (211) - E 240 V6 18V	112.913/-917	2597	03/02>	6513.87	 6953 NEW
2.7 CDI (210) - E 270 CDI	612.961	2685	06/99>	6846.87	
2.7 CDI (211) - E 270 20V	612.961	2685	06/99>	6846.92	 6953 NEW
	647.961	2685	03/02>05/05	6847.92	
2.8 (124) - E 280 / E 280L / E 280T	104.942	2799	07/93>02/96	1476.87	 6953 NEW
2.8 (210) - E 280	104.945	2799	04/95>06/99	1476.87	
2.8 (210) - E 280	104.945	2799	04/95>06/99	6247.87	 6953 NEW
	104.945	2799	04/95>06/99	6247.87	
2.8 (210) - E 280 / E 280 L / E 280T	112.921	2799	04/95>	6513.87	 6953 NEW
2.9 TD (210) - E 290 TD / E 290 TDL / E 290T TD	602.982	2874	04/95>	5699.85	
3.0 (124) - E 300 / E 300T	103.985	2962	07/93>02/96	1476.87	 6953 NEW
3.0 TD (124) - E 300TD / E 300T TD	603.960 / .963	2996	07/93>02/96	5699.80	
3.0 TD (210) - E 300 TD	606.962	2996	04/95>06/99	5699.80	 6953 NEW
3.0 D (124) - E 300D / E 300T D	606.910	2996	07/93>02/96	5699.85	
3.0 D (210) - E 300 D	606.912	2996	04/95>06/99	5699.85	 6953 NEW
3.2 (124) - E 320 / E 320T	104.992	3199	07/93>	1476.87	
3.2 (210) - E 320	104.995	3199	04/95>06/99	1476.87	 6953 NEW
3.2 (210) - E320 / E 320 T	112.941	3199	04/95>	6513.87	
3.2 CDI (211) - E 320 V6 18V	112.949	3199	03/02>	6513.87	 6953 NEW
3.2 CDI (211) - E 320 24V	648.961	3222	03/02>	6847.92	
3.2 CDI (210) - E 320 CDI	613.961	3224	06/99>	6846.92	 6953 NEW
3.6 (124) - E360 / E 36 AMG	C36AMG	3606	05/94>	1476.87	
4.0 CDI (211) - E400	628.961	3996	03/04>	6953.92	 6953 NEW
4.2 (124) - E 420	119.975	4196	07/93>	6543.80	
4.2 (124) - E 420	119.975	4196	07/93>09/95	6849.80	 6953 NEW
4.2 (210) - E 420	119.985	4196	04/95>06/99	6849.80	
4.3 (210) - E 430 / E 430 T	113.940	4266	04/95>	6513.87	 6953 NEW
5.0 (211) - E 500 V8 24V	113.967/-969	4966	03/02>	6513.87	
5.0 (124) - E 500	119.974	4973	07/93>	6543.80	 6953 NEW
	119.974	4973	07/93>09/95	6849.80	
5.0 (210) - E 50	119.AMG	4973	03/96>06/99	6849.80	 6953 NEW
5.0 (124)	449.974	4973	07/93>09/95	6849.80	
5.4 (210) - E 55 / AMG / E 55T AMG	113.980	5439	03/96>	6513.87	 6953 NEW



LISTE D'APPLICATIONS

APPLICATION LIST/ANWENDUNGSLISTE

VEHICULE MODEL FAHRZEUGTYP	MOTEUR ENGINE MOTOR	CYLINDRÉE ENGINE SIZE HUBRAUM	ANNÉE YEAR JAHR	VERNET	PHOTOS PICTURES ZEICHNUNGEN
Class G					
2.0 (M460)	102.965	1997	09/89>	1476.87	 1476
2.0 (M460) - 200 G / GE	102.964	1997	05/86>07/89	5963.92	 1535
2.0 (M463) - 200 GE	102.965	1997	09/89>	5963.92	
2.3 (M460)	102.989	2299	06/96>06/93	1476.87	
2.3 (M463) - 230 GE	102.989	2299	09/89>	5963.92	
2.3 (M460) - 230 GE	115.973	2307	03/79>08/85	1476.87	
2.4 D (M460) - 240 GD	616.936	2399	03/79>11/89	1535.80	
2.5 D (M460) - 250 GD	602.930	2497	08/87>11/89	5699.85	 5699
2.5 D (M463) - 250 GD	602.931	2497	09/89>	5699.85	 5963
2.7 (M460) - 280 GE	110.994	2746	11/79>11/89	1476.87	
2.9 D (M463) - 290 GD	602.942	2874	01/92>	5699.85	
3.0 (M463) - 300 GE 2400	103.987	2962	09/89>	1476.87	
3.0 TD (M463) - G 300 TD	606.964	2996	09/96>	5699.80	
3.0 TD (M463) - G 300 TD 2400 / 300 GD	603.931	2996	09/89>	5699.85	 6285
3.0 D (M460) - 300 GD	617.931	2998	03/79>11/89	1535.80	 6513
3.2 (M463) - G 320 / A / E	104.996	3199	10/93>	1476.87	
3.5 TD (M463) - G 350 TD / 350 GD	603.972	3449	03/92>08/96	5699.80	
3.0 TD (M463) - G 300 TD 2400 / 300 GD	117.965	4973	01/92>07/93	6543.80	
5.0 (M463) - G 500 E / 500 GE	117.965	4993	01/92>07/93	6543.80	
Class M					
2.3 (M163) - ML 230	111.977	2295	10/97>	6285.87	 6543
2.7 CDi (M163) - ML 270CDi	612.963	2668	07/99>	6850.87	 6846
3.2 (M163) - ML 320	112.942	3199	05/97>	6513.87	
4.3 (M163) - ML 430	113.942	4266	03/98>	6513.87	
5.0 (M163) - ML 500	113.965	4966	09/00>	6513.87	
5.4 (M163) - ML 55 AMG	119.AMG54	5439	09/99>	6513.87	
Class ML NEW					
2.3 (163) - 230	111.977	2295	10/97>	6285.87	
2.7 CDi (163) - 270 CDi	612.963	2668	07/99>	6850.87	
3.2 (163) - 320	112.942	3199	05/97>08/02	6513.87	
3.7 (163) - 350	112.970	3724	09/00>	6513.87	
4.0 CDi (163) - 400 CDi	628.963	3996	09/00>	6953.92	
4.3 (163) - 430	113.942	4266	03/98>	6513.87	
5.0 (163) - 500	113.965	4966	09/00>	6513.87	
5.4 (163) - 55 AMG	113.981	5439	09/99>	6513.87	
Class S					
2.6 (126) - 260 SE / 300 SD	103.941	2599	08/80>12/91	1476.87	
2.7 (116) - 280 S	110.922/ .932	2746	09/72>07/80	1476.87	
2.7 (116) - 280 SE, SEL	110.985/ .993	2746	08/72>07/80	1476.87	
2.7 (126) - 280 S, SE, SEL	110.924 / .987	2746	09/79>09/85	1476.87	
2.8 (140) - S 280 / S 280 SE / 300	104.944	2799	10/92>08/98	1476.87	
2.8 (220) - S 280	112.922	2799	03/99>	6513.87	
3.0 (126) - 300 SE, SEL	103.981	2962	09/85>07/91	1476.87	
3.0 TD (140) - S 300 TD	606.961	2996	08/96>08/98	5699.80	
3.2 (140) - 300 / S 320 / S 320L / S 320 SE	104.990 / .994	3199	03/91>08/98	1476.87	
3.2 (220) - S 320 / S 320 L	112.944	3199	09/98>	6513.87	
3.2 (220)	648-960	3222	09/02>	6847.92	
3.2 CDI (220) - S 320 CDI / S 320 CDIL	613.960	3224	01/00>03/00	6846.87	
	613.960	3224	04/00>09/02	6846.92	
					 6953 NEW



LISTE D'APPLICATIONS

APPLICATION LIST/ANWENDUNGSLISTE

VEHICULE MODEL FAHRZEUGTYP	MOTEUR ENGINE MOTOR	CYLINDRÉE ENGINE SIZE HUBRAUM	ANNÉE YEAR JAHR	VERNET	PHOTOS PICTURES ZEICHNUNGEN
...Class S					
3.5 TD (140) - 300 TD / S 350 TD	603.971	3449	03/92>08/98	5699.80	 1476
3.5 (116) - 350 SE, SEL	116.985	3499	09/72>03/80	6544.75	 5699
3.7 (220) - S 350	112.972 / .975	3724	09/02>	6513.87	
3.8 (126) - 380 SE, SEL	116.961	3818	01/80>09/85	6544.75	
4.0 CDI (220) - S400 CDI	628.960	3996	04/00>	6953.92	
4.2 (126) - 420 SE / SEL	116.965	4196	09/85>12/91	6543.80	
4.2 (140) - 400 / CL 420 / S 420 / S 420 L	119.971	4196	03/91>07/99	6543.80	 6247
4.2 (126) - 420 SEC	116.965	4196	09/85>12/91	6543.80	 6285
4.2 (140) - SEC / SL 420	119.971	4196	03/94>	6543.80	
4.2 (140) - 400 / CL 420 / S 420 / S 420 L	119.971	4196	03/91>07/99	6849.80	
4.3 (220) - S 430 / S 430 L	113.941	4266	09/98>02/00	6513.87	
4.3 (220)	113.948	4266	09/02>	6513.87	 6513
4.5 (116) - 450 SE, SEL	117.983	4520	11/72>04/80	6544.75	 6543
5.0 (220) - S 500 / S 500 L	113.960 / .966	4966	09/98>09/04	6513.87	
5.0 (215) - CL 500	113.960	4966	08/99>	6513.87	
5.0 (126) - 500 SE / SEL	117.961 / .963	4973	09/85>06/91	6543.80	
5.0 (140) - 500 / S 500 / S 500 L	119.970	4973	03/91>07/99	6543.80	 6544
5.0 (140) - SEC / SL 500	119.980	4973	01/92>07/99	6543.80	 6849
5.0 (140) - 500 / CL 500 / S 500 / S 500 L	119.970	4973	01/92>07/99	6849.80	
5.0 (140) / 5.0 (C140) - SEC / SL 500	119.980	4973	07/93>07/99	6849.80	
5.0 (126) - 500 SEC	117.963	4993	09/81>07/89	6543.80	
5.0 (126) - 500 SE, SEL	117.961	4993	09/85>06/91	6544.75	
5.4 (220) - S 550 / S 55A MG / S 55 AMGL	113.986	5439	01/00>	6513.87	 6953
5.5 (126) - 560 SE / SEL	117.968	5547	09/85>12/91	6543.80	 6962
5.5 (126) - 560 SEC	117.968	5547	09/85>12/91	6543.80	NEW NEW
Coupé					
2.0 (124) - 200 CE	102.963	1997	03/87>06/92	1476.87	
2.0 (124) - 200 CE 16V	111.940	1998	10/92>06/93	6285.87	
2.2 (124) - 220 CE	111.960	2199	10/92>06/93	6285.87	
2.3 (123) - 230 C	102.980 / .982	2299	06/80>07/92	1476.87	
	115.954	2307	03/77>04/80	1476.87	
2.7 (123) - 280 C	110.923 / .984	2746	03/77>03/80	1476.87	
2.7 (123) - 280 CE	110.988	2749	08/80>07/85	1476.87	
3.0 (124) - 300 CE	103.983 / .980	2962	05/87>06/93	1476.87	
3.2 (124) - 320 CE	104.992	3199	10/92>06/93	1476.87	
Coupé CLK					
1.8 GCl (208) - CLK200	271.942	1796	03/02>	6962.90	
1.8 (208) - 200	271.940	1796	03/02>	6962.90	
2.0 (208) - 200	111.945	1998	06/97>	6247.87	
2.0 (208) - 200 / 200 K / 200 Kompressor	111.944 / .945 / .956	1998	06/97>	6285.87	
2.0 (208) - 200	111.945	1998	06/98>	6513.87	
2.3 (208) - 230 K / 230 Kompressor	111.975 / .982	2295	06/97>	6285.87	
2.6 (209) - 240 V6 18V	112.912	2597	03/02>	6513.87	



LISTE D'APPLICATIONS

APPLICATION LIST/ANWENDUNGSLISTE

VEHICULE MODEL FAHRZEUGTYP	MOTEUR ENGINE MOTOR	CYLINDRÉE ENGINE SIZE HUBRAUM	ANNÉE YEAR JAHR	VERNET
...Coupé CLK				
2.7 (209) - 270 CDI	612967	2685	03/02>	6884.92
3.2 (208) - 320	112.940	3199	06/97>	6513.87
3.2 (209) - 320 V6 18V	112.955	3199	03/02>	6513.87
4.3 (208) - 430	113.943	4266	06/98>	6513.87
5.0 (209) - 500 V8 24V	113.968	4966	03/02>	6513.87
5.4 (208) - 55 AMG	113.984	5439	06/99>	6513.87
5.4 (209) - 55 AMG V8 24V	113.987	5439	03/02>	6513.87
Coupé SL				
2.7 (107) - 280 SLC	110.982 / .986	2746	07/74>08/81	1476.87
3.5 (107) - 350 SLC	116.982 / .984	3499	10/71>02/80	6544.75
3.7 (230) - SL350	112.973	3724	03/03>	6513.87
3.8 (107) - 380 SLC	116.960	3818	03/81>08/81	6544.75
5.0 (230) - SL500	113.963	4966	08/01>	6513.87
5.0 (107) - 450 SLC / 500 SLC	117.960	4973	04/78>07/81	6544.75
5.4 (230) - SL55 AMG	113.992	5439	08/01>	6513.87
Coupé SLK				
1.8 (R170) - 200K	271.944	1796	01/04>	6962.90
2.0 (R170) - 200 / 200K	111.943 / .946	1998	08/96>03/00	6285.87
2.0 (R170) - 200K / 200 Kompressor	111.958	1998	04/00>12/03	6285.87
2.3 (R170) - 230K / 230 Kompressor	111.973 / .983	2295	08/96>12/03	6285.87
3.2 (R170) - 320/32AMG	112.947	3199	01/00>12/03	6974.87
SL Roadster				
2.7 (R107) - 280 SL	110.982/986 / .992	2746	07/74>07/85	1476.87
2.8 (R129) - 280	104.943	2799	08/93>07/01	1476.87
3.0 (R129) - 300 / SL 24V	104.981	2960	03/89>07/93	1476.87
3.0 (R107) - 300 SL	103.982	2962	09/85>08/89	1476.87
3.0 (R129) - 300 / SL	103.984	2962	03/89>07/93	1476.87
3.2 (R129) - 320 / SL	104.991	3199	08/93>07/01	1476.87
3.5 (R107) - 350 SL	116.982 / .984	3499	04/71>02/80	6544.75
3.8 (R107) - 380 SL	116.960	3818	03/80>08/85	6544.75
4.2 (R107) - 420 SL	116.964	4196	09/85>08/89	6543.80
5.0 (R107) - 500 SL	117.964	4973	09/85>08/89	6543.80
5.0 (R129) - 500	119.960 / .972 / .982	4973	03/89>	6543.80
5.0 (R107) - 500 SL	117.960	4973	04/80>08/81	6544.75
5.0 (R129) - 500	119.972 / .982	4973	03/89>07/01	6849.80
5.5 (R107) - 550 SL / 560 SL	117.967	5547	09/85>08/89	6543.80
MERCEDES				
				
MB				
2.4D 100D	616.963	2399	09/89>01/96	5699.80
Minibus				
2.4D	616.963	2399	09/89>01/96	5699.80
Sprinter				
2.2 - 208CDI 30 / 30P / 35 / 35P	611DE22LA	2151	11/99>	6847.87
2.2 - 211CDI 30 / 30P / 35 / 35P	611DE22LA	2151	11/99>	6847.87
2.2 - 213CDI 30 / 30P / 35 / 35P	611DE22LA	2151	11/99>	6847.87
2.3 - 208 E	111.979	2295	02/95>	6285.87

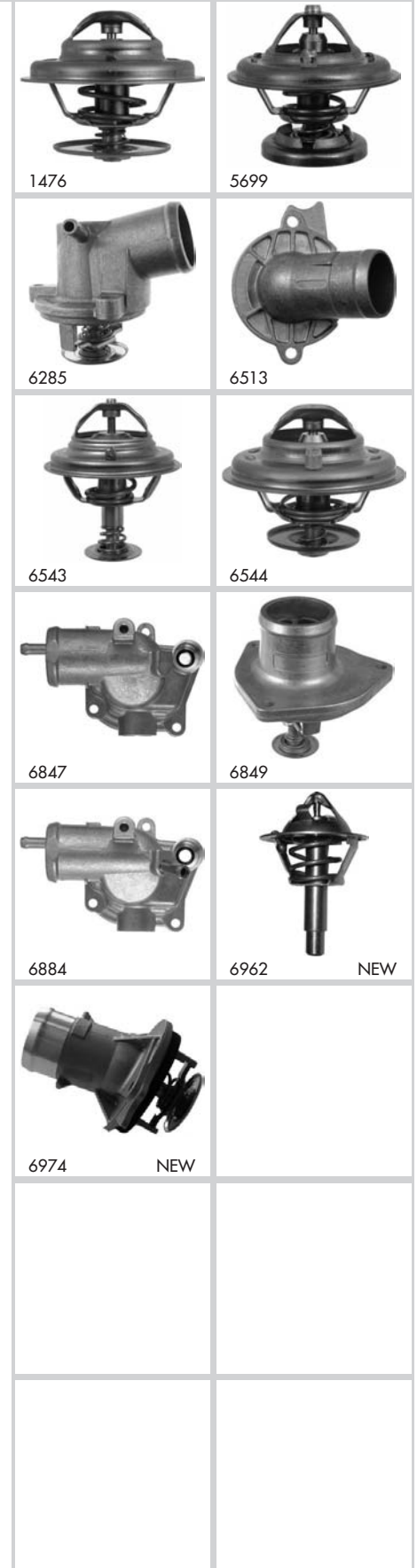









LISTE D'APPLICATIONS

APPLICATION LIST/ANWENDUNGSLISTE

VEHICULE MODEL FAHRZEUGTYP	MOTEUR ENGINE MOTOR	CYLINDRÉE ENGINE SIZE HUBRAUM	ANNÉE YEAR JAHR	VERNET	PHOTOS PICTURES ZEICHNUNGEN
...Sprinter					
2.3 - 214 30 / 35	111.979	2295	02/95>	6285.87	 1476
2.3 - 314 30 / 35 / 40	111.979	2295	02/95>	6285.87	 1513
2.3 - 414 35 / 40	111.979	2295	02/95>	6285.87	
2.3 D - 208D 30 / 35	601.943	2299	02/95>	5699.85	
2.3 D - 308D 30 / 35 / 40	601.943	2299	02/95>	5699.85	
2.3 D - 408D 35 / 40	601.943	2299	02/95>	5699.85	
2.7 D - 616CDI 35 / 40	612.981	2686	06/01>	6847.87	
2.9 D - 210D	602.980	2874	02/95>	5699.85	
2.9 D - 212D 30 / 35	602.980	2874	02/95>	5699.85	 1535
2.9 D - 312D 30 / 35 / 40	602.980	2874	02/95>	5699.85	 5699
2.9 D - 412D 35 / 40	602.980	2874	02/95>	5699.85	
Transporter					
2.3 - 210	102.942	2299	03/82>	5963.92	 5963
2.3 - 208 / 210 / 308 / 310 / 410	102.945	2299	03/82>	1476.87	 6285
2.3 - 208 / 210 / 308 / 310	115.955 / .972	2307	04/77>03/82	1513.83	
2.3 - 208 / 210 / 308 / 310 / 410	102.942	2299	03/82>	5963.92	
2.3 D - 208D / 210D / 308D / 408D	601.940	2299	09/88>	5699.85	
2.3 D - 210 D	616.913	2404	06/81>	1535.80	
2.4 D - 207D / 307D	616.917 / .934	2404	05/77>02/82	1535.80	 6513
2.4 D - 207D / 307D / 407D	616.913 / .917 / .934	2404	05/77>	1535.80	 6514
2.4 D - 207D / 307D	616.937 / .939	2404	04/77>	1535.80	
2.9 D - 210D / 310D / 410D	602.940	2874	09/88>	5699.85	
3.0 D - 209D / 309D / 409D	617.913	2998	03/82>	1535.80	 6515
Class V					
2.0 - V 200	111.948	1998	10/96>12/02	6285.87	 6847
2.3 - V 230	111.978	2295	10/96>12/02	6285.87	
2.3 TD - V 230 TD	601.970	2299	10/96>12/02	5699.80	
2.8 - V 280	104.900	2799	10/96>12/02	1476.87	
Vaneo					
1.6	166.82 / .961	1598	10/01>	6514.87	
1.7 CDI	668.914	1689	10/01>	6515.87	
1.9	166.961 / .991	1898	10/01>	6514.87	
Viano					
2.0 CDI	646.982	2148	01/03>	6847.87	
2.2 CDI	646.982	2148	01/03>	6847.87	
3.0	112.951	3199	01/03>	6513.87	
3.2	112.951	3199	01/03>	6513.87	
Vito					
2.0 - 113	111.948	1998	01/96>09/03	6285.87	
2.1 CDI - 109 / 111 / 115	666.982 / .983	2148	01/03>	6847.87	
2.3 D - 108 / 114	601.942	2299	01/96>09/03	5699.80	
2.3 TD - 110D / 114 TD	601.970	2299	01/96>09/03	5699.80	
3.2 - 119 / 122	112.951	3199	01/03>	6513.87	











VEHICULE MODEL FAHRZEUGTYP	MOTEUR ENGINE MOTOR	CYLINDRÉE ENGINE SIZE HUBRAUM	ANNÉE YEAR JAHR	VERNET	PHOTOS PICTURES ZEICHUNGEN
MINI					
MINI					
1.4 d One	1ND	1364	05/03>	6587.82	 1416
1.6 16V - Cooper / Cooper S / One	W10B16A	1598	09/01>	6843.91	 5075
MITSUBISHI					
Carisma					
1.6	4G92-21 / 21L / 21S	1597	05/95>07/98	5434.82	 5434
	4G92-21 / 21L / 21S	1597	05/95>02/99	5434.88	
	4G92-21 / 21L / 21S	1597	08/98>02/99	6295.82	
	4G92-23	1597	05/95>07/98	5434.82	
	4G92-23	1597	05/95>02/99	5434.88	
	4G92-23	1597	08/98>02/99	6295.82	
1.8	4G92-28Q / 28R / 2ML	1597	03/99>	5434.88	 6318
	4G93-G36 / G82	1834	03/99>	6295.85	
1.8 16V	4G93-G83	1834	03/99>	6295.82	 6583
	4G93-21	1834	05/95>07/98	5434.82	
	4G93-21	1834	05/96>02/99	5434.88	
	4G93-21 / 23	1834	08/98>02/99	6295.82	
	4G93-23 / 41	1834	05/96>07/98	5434.82	
	4G93-23 / 41	1834	05/96>02/99	5434.88	
1.8 GDI 16V	4G93-G10 / G30	1834	05/97>02/99	6295.85	 6587
1.9 DI-D	F9Q1 / F9Q2	1870	03/99>	6318.89	
1.9 TD	F8Q	1870	05/96>	6318.89	
Challenger					 6843
2.5 TD	4D56T-4P	2477	10/98>	5434.82	
3.0	6G72-8-GC	2972	10/98>	6583.88	
Colt					
1.2	4G16	1198	01/84>06/88	5075.88	
1.3	4G13	1244	03/84>10/87	1416.88	
	4G13 / 2J	1299	08/90>12/96	5075.82	
	4G13 / -2J / -ESI	1299	04/88>12/96	5075.88	
	4G13-38	1299	11/95>	5434.76	
	4G13-38	1299	11/95>	6295.82	
	4G13-380	1299	12/97>	6295.82	
	G13B	1299	06/86>06/88	5075.88	
1.4	4G12	1410	04/79>03/84	1416.88	
1.5	4G15	1468	11/77>02/84	1416.82	
	4G15	1468	11/95>	5434.76	
	4G15 / B / -MPI / MPIC	1468	07/85>05/92	5075.88	
	4G15 / -MPI / -MPIC	1468	05/89>05/92	5075.82	
	MIT03-150	1468	06/05>	6295.82	
1.6 16V	4G61-MPI / MPIC	1596	04/88>05/90	5075.82	
	4G61-MPI / MPIC	1596	04/88>05/90	5075.88	
1.6 Turbo	4G32T	1597	11/77>02/84	1416.88	
	4G32T	1597	01/84>06/88	5075.88	
	4G92	1597	12/91>06/92	6295.76	
	4G92 / -31 / -38	1597	07/92>	6295.82	



LISTE D'APPLICATIONS

APPLICATION LIST/ANWENDUNGSLISTE

VEHICULE MODEL FAHRZEUGTYP	MOTEUR ENGINE MOTOR	CYLINDRÉE ENGINE SIZE HUBRAUM	ANNÉE YEAR JAHR	VERNET	PHOTOS PICTURES ZEICHNUNGEN		
...Colt							
1.8	4G67 / 4G67-C	1836	11/89>05/92	5075.82	 1416  5075		
	4G67 / 4G67-C	1836	11/89>05/92	5075.88			
	4G93-1	1834	12/91>06/92	5434.76			
	4G93-1	1834	07/92>12/96	6295.82			
1.8 D	4D65	1795	01/84>06/88	6577.82	 5434  5792		
	4D65 / 4D65-C	1795	04/88>05/92	5075.82			
Cordia							
1.6	4G32	1597	06/82>10/86	1416.88	 6276  6295		
Galant							
1.6	4G32	1597	05/76>05/90	1416.88	 6577  6583		
	4G32	1597	05/84>10/92	5075.88			
	4G32	1597	11/87>10/92	5075.82			
1.8	4G37	1755	07/88>10/92	5075.82			
	4G37 / 7F / 7J	1755	12/87>10/92	5075.88			
	4G93-OM3	1834	11/92>05/96	5434.76			
	4G93-OM3	1834	11/92>05/96	6295.82			
1.8 TD	4D65	1795	05/86>07/93	5792.83			
	4D65-1D / 1T	1795	11/89>10/92	5075.82			
	4D65T / 4D65-1D / 1T	1795	05/84>05/90	6577.82			
2.0	4G63	1997	06/90>10/92	5075.82			
	4G63 / 3L / 3P	1997	12/87>10/92	5075.88			
	4G63-68 / -6M	1997	11/92>10/96	6295.76			
	4G63-68 / -6M	1997	11/92>05/96	6295.82			
	4G63-6G	1997	10/96>02/00	6295.82			
	4G63-6M / -6T	1997	10/96>02/00	6295.82			
	4G63-C / 4G63T	1997	05/84>11/87	5075.88			
	6A12	1997	11/92>05/96	6295.82			
	2.0 16V	4G63-5 / 5B / 5F	1997	12/87>10/92		5075.82	
		4G63-5 / 5B / 5F	1997	12/87>10/92		5075.88	
2.0 TD	4D68-4E	1998	10/96>02/00	6295.82			
	4D68T-1	1998	11/92>10/96	6295.76			
	4D68T-1	1998	11/92>10/96	6295.82			
2.0 Turbo	4G63T	1997	05/86>02/88	5792.83			
2.4	G64B	2351	07/85>11/87	5075.88			
2.4 GTI	4G64-41	2351	12/98>09/02	6295.85			
2.5	6A13-4	2497	10-96>03/00	6295.82			
	6G73	2497	11/92>05/96	6583.82			
Grandis NEW							
2.0 DiD	NA8W	1999	01/04>	6276.87			
2.4	4G69	2378	01/04>	6295.82			
L200							
1.6	4G32	1597	11/86>05/94	5075.88			
	4G32	1597	03/90>03/95	5075.82			
2.0	4G63-6H	1997	01/96>	6295.82			
	4G63-C	1997	11/86>05/95	5075.82			
2.0 2WD	4G63-C	1997	11/86>05/95	5075.88			
2.4	4G64	2351	06/90>11/97	5075.88			
	4G64-2G	2351	01/96>	6295.82			
2.5 D	4D56	2477	11/92>	5792.76			
	4D56	2477	01/86>	5792.83			
2.5 TD	4D56T+ / -5	2477	01/96>07/01	5434.82			
	4D56T-4P-115	2477	07/01>	5792.83			
2.6	G54B	2555	11/89>05/95	5075.88			
3.0	6G72	2972	06/90>05/91	5075.88			







LISTE D'APPLICATIONS

APPLICATION LIST/ANWENDUNGSLISTE

Thermostats

Mitsubishi

VEHICULE MODEL FAHRZEUGTYP	MOTEUR ENGINE MOTOR	CYLINDRÉE ENGINE SIZE HUBRAUM	ANNÉE YEAR JAHR	VERNET	PHOTOS PICTURES ZEICHNUNGEN
L300					
1.4	4G33	1410	03/90>06/90	5075.82	
1.6	4G32	1597	11/86>05/94	5075.88	
	4G32	1597	03/90>05/94	5075.82	
2.0	4G63	1997	06/94>06/95	5434.76	
	4G63	1997	06/94>	6295.82	
	4G63 / G63B	1997	11/88>06/95	5075.82	
2.0 4WD	4G63 / G63B	1997	11/86>06/95	5075.88	
2.4	4G64 / G64B18	2351	11/86>05/96	5075.88	
2.5 D / TD	4D56 / 4D56T	2477	11/86>	5792.83	
2.5 TD	4D56T	2477	12/87>07/95	5792.76	
L400					
2.0 16V	4G63-AF / 6F	1997	12/94>	6295.82	
2.4	4G64-2	2351	12/94>	6295.82	
2.5	4D56T-2D	2477	12/94>07/95	5792.76	
	4D56T-2D	2477	08/95>	5792.83	
Lancer					
1.2	4G16	1198	01/84>05/92	5075.88	
1.3	4G13	1299	01/84>06/88	6577.82	
	4G13 / 2J	1299	04/88>	5075.82	
	4G13 / -2J / -ESI / -MPI	1299	10/87>12/96	5075.88	
	4G13-38	1299	11/95>	5434.76	
	4G13-38	1299	11/95>	6295.82	
	4G16-6	1299	06/03>	6295.88	
1.4	4G12	1410	02/75>10/82	1416.88	
1.5	4G15 / 4G15-MPI	1468	07/85>07/95	5075.82	
	4G15 / G15B	1468	01/84>11/91	5075.88	
	4G15-5	1468	12/91>10/96	5075.82	
	4G15-5	1468	11/95>	5434.76	
	4G15-ECI / MPI	1468	04/88>05/92	5075.88	
1.6	4G18-6	1584	06/03>	6295.88	
	4G92	1597	09/79>02/83	1416.88	
	4G92-01 / 0G	1597	07/85>03/92	6577.82	
	4G92-38	1597	12/97>	5075.88	
1.6 16V	4G61-MPI / MPIC	1596	04/88>05/90	5075.82	
1.6 4WD	4G92 / 01 / 0G / 0H	1597	06/92>	6295.82	
	4G92 / 01 / 0H	1597	05/92>06/92	6295.76	
1.8	4G37 / -7G / -MPI	1755	11/86>05/92	5075.88	
	G37B	1755	11/86>05/90	5075.88	
1.8 16V	4G67 / 4G67-C	1836	11/89>05/92	5075.82	
	4G67 / 4G67-C	1836	11/89>05/92	5075.88	
	4G93-1	1834	07/92>12/96	6295.82	
	4G93-1	1834	05/92>06/92	5434.76	
1.8 D	4D65	1795	01/84>03/92	6577.82	
	4D65 / 4D65-C	1795	04/88>05/92	5075.82	
2.0	4G63	1997	11/77>03/84	1416.88	
	4G63-7	1997	06/03>	6295.82	
	4G63-7TC	1997	01/98>01/99	5434.76	
2.0 D	4D68 / 0A / OE / OF	1998	05/92>07/95	6295.76	
	4D68-0A / OE	1998	05/94>12/96	6295.82	
Montero Sport					
2.5	4D56T-4P	2477	08/98>	5434.82	
3.0	6G72-8-GG	2972	08/98>	6583.88	
Outlander					
2.0	4G63-7T3	1997	06/03>	6295.82	



1416



5075



5434



5792



6295



6577



6583



LISTE D'APPLICATIONS











APPLICATION LIST/ANWENDUNGSLISTE

VEHICULE MODEL FAHRZEUGTYP	MOTEUR ENGINE MOTOR	CYLINDRÉE ENGINE SIZE HUBRAUM	ANNÉE YEAR JAHR	VERNET	PHOTOS PICTURES ZEICHUNGEN
...Outlander					
2.4	4G69-2	2378	09/03>	6295.82	
Pajero					
1.8	4G93-D	1834	09/01>	6295.82	
1.8 GDI	4G93-H	1834	08/99>	6295.82	
2.0 GDI	4G94-H	1999	07/00>	6295.82	
2.3 TD	4D55T	2346	01/83>04/86	5792.76	
2.4	4G64	2351	12/90>05/94	5075.88	
2.5 D	4D56	2477	04/91>05/99	5792.83	
2.5 D / TD 4WD	4D56 / 4D56T	2477	05/86>07/93	5792.76	
2.5 TD	4D56T-4P	2477	08/98>07/01	5434.82	
2.5 TD 4WD	4D56T-1 / 2D	2477	08/95>11/95	6295.82	
2.6	G54B	2555	05/86>06/91	5075.88	
2.6 4WD LWB	4G54-1G / -1HL	2555	01/83>04/95	5075.88	
2.8 D	4M40-0AZ	2834	06/94>05/99	6295.76	
2.8 TD 4WD	4M40-0A / -2A	2835	11/93>	6295.76	
3.0	6G72-1	2972	12/90>05/92	5075.82	
	6G72-8-GG / 6G72-8H	2972	06/97>	6583.88	
	6G72-8H	2972	06/94>05/97	6583.82	
3.0 4WD V6	6G72 / 6G72-1	2972	11/88>05/94	5075.88	
3.2 DI-D	4M410A	3200	02/00>	6295.76	
3.5	6G74	3497	06/97>	6583.88	
	6G74 / -B	3497	11/93>	6583.82	
Sapporo					
1.6	4G32	1597	05/76>09/84	1416.82	
	4G32	1597	10/84>02/88	5075.82	
2.0	4G63	1997	05/76>09/84	1416.82	
Shoqun					
1.8	4G93-D	1834	09/01>	6295.82	
1.8 GDI	4G93-H	1834	08/99>	6295.82	
2.0 GDi	4G94-H	1999	07/00>	6295.82	
2.3 TD	4D55T	2346	01/83>04/86	5792.76	
2.5 D	4D56	2477	04/91>05/99	5792.83	
2.5 TD	4D566-05 / -09 / -14	2477	05/86>06/91	5792.76	
	4D56T-1	2477	08/95>11/95	6295.82	
	4D56T-1	2477	12/95>	5434.82	
2.6 4WD	4G54-1G	2555	01/83>06/91	5075.88	
2.8 D / TD	4M40-0A / -0AZ / -2A	2834	11/93>	6295.76	
3.0	6G72-8H	2972	06/94>05/97	6583.82	
	6G72-8H	2972	06/97>	6583.88	
3.0 V6	6G72-1 / -1F	2972	11/88>05/94	5075.88	
3.2 DI-D	4M410A	3200	02/00>	6295.76	
3.5	6G74	3497	06/97>	6583.88	
3.5 GDI	6G74 / -B	3497	11/93>	6583.82	
Sigma					
3.0	6G724	2972	10/90>05/94	6583.82	
3.0 V6	6G721	2972	12/90>	5075.88	
Space Gear					
2.0 16V	4G63-6F / 6M	1997	12/94>	6295.82	
2.4 16V 4WD	4G64-2	2351	12/94>	6295.82	
2.5 TD	4D56T-2E	2477	12/94>05/95	5792.76	
	4D56T-2E	2477	08/95>11/95	6295.82	
	4D56T-2E	2477	12/95>	5434.82	
	4D56T-4	2477	12/95>	5434.82	



LISTE D'APPLICATIONS









APPLICATION LIST/ANWENDUNGSLISTE

VEHICULE MODEL FAHRZEUGTYP	MOTEUR ENGINE MOTOR	CYLINDRÉE ENGINE SIZE HUBRAUM	ANNÉE YEAR JAHR	VERNET	PHOTOS PICTURES ZEICHNUNGEN
Space Runner					
1.8	4G93	1834	02/92>	6295.82	 3357
	4G93 / -0M3	1834	06/91>	5434.76	
2.0	4G63-MPI	1997	05/99>	6295.82	 5079
2.0 TD	4D68T	1998	06/92>	6295.76	
2.4 GDi	4G64-414	2351	05/99>	6295.82	 5971
Space Star					
1.3	4G13-16	1299	06/98>	6295.88	 6295
1.6	4G18	1597	04/01>	6295.88	
1.8 GDI	4G93 / 4G93-H	1834	06/00>	6295.82	 6314
	4G93-H	1834	10/98>05/00	6295.85	
1.9 DI-D	F9Q1 / F9Q2	1870	06/00>	6318.89	 6577
Space Wagon					
1.8	4G37	1755	10/83>04/91	5075.88	 6314
	4G93	1834	02/92>05/92	6295.82	
	4G93 / 4G93-0M3	1834	05/91>05/92	5434.76	
1.8 TD	4D65T	1795	07/85>04/91	6577.82	 6318
	4D65T	1795	05/91>05/92	5075.82	
2.0	4G63-34 / -3J / G63B0	1997	02/85>04/91	5075.88	 6577
	4G63-6	1997	06/92>11/00	6295.82	
	4G63-MPI	1997	06/00>	6295.82	
2.0 TD	4D68T	1998	06/92>11/00	6295.82	 6577
	4D68T	1998	06/92>11/00	6295.76	
2.4	4G64	2351	06/92>05/96	6295.82	 6577
2.4 GDi	4G64	2351	07/98>04/02	5434.88	
	4G64-412 / -414	2351	07/98>08/99	6295.85	
4G64-412 / -414 / -481	2351	07/98>	6295.82		
Starion NEW					
2.0	4G63-0R / 4G63-0W	1997	02/82>05/88	5075.88	
2.6	G54B-1J	2555	06/86>03/90	5075.88	
NISSAN					
100 NX					
1.6	GA16DE	1597	10/92>10/94	3357.82	
	GA16DS	1597	10/90>10/92	5079.76	
2.0	SR20DEB	1998	10/90>10/92	6314.76	
	SR20DEB	1998	10/92>10/94	6314.82	
200 SX					
1.8 Turbo 16V	CA18DT / DTAP	1809	09/88>06/94	5971.82	
2.0 Turbo 16V	SR20DET	1998	04/94>	6295.82	
	SR20DET	1998	04/94>	6314.76	
280 ZX					
2.8	L28	2753	06/78>09/78	5971.82	
	L28	2753	09/78>07/83	5971.88	



LISTE D'APPLICATIONS

APPLICATION LIST/ANWENDUNGSLISTE

VEHICULE MODEL FAHRZEUGTYP	MOTEUR ENGINE MOTOR	CYLINDRÉE ENGINE SIZE HUBRAUM	ANNÉE YEAR JAHR	VERNET	PHOTOS PICTURES ZEICHNUNGEN
300 ZX					
3.0	VG30DETT	2960	01/90>09/95	6851.76	
	VG30E / ET / T / TDP	2960	02/84>01/89	6851.76	
350 Z					
3.5 V6 24V	VQ35DE	3498	07/03>	6860.76	
Almera					
1.4 16V	GA14DE	1392	07/95>01/00	3357.82	
	GA14DE	1392	01/98>01/00	5079.82	
1.5 16V	QG15DE	1497	02/00>	5079.82	
1.6 16V	GA16DE	1597	07/95>01/00	3357.82	
	GA16DE	1597	01/98>01/00	5079.82	
1.8 16V	QG18DE	1769	02/00>	5079.82	
2.0 16V	SR20DEB	1998	04/96>01/00	6314.76	
2.0 D	CD20	1974	07/95>01/00	6295.82	
	CD20	1974	07/95>01/98	6295.88	
2.2 TDi	YD22-110	2184	02/00>01/03	6583.82	
2.2 VDi	YD22-110	2184	03/01>01/03	6583.82	
Almera II					
1.5 16V	QG15DE	1498	02/03>	5079.82	
1.5 DCi	K9K.7	1461	02/03>	6666.89	
1.8 16V	QG18DE	1769	02/03>	5079.82	
2.2 DCi	YD22DDTI / 112	2184	02/03>	6583.82	
Almera Tino					
1.8 16V	QG18DE	1769	08/00>	5079.82	
2.0 16V	SR20DE	1998	08/00>01/03	5079.82	
2.2 DCi	YD22DDTI / 114	2184	02/03>	6583.82	
2.2 VDi	YD22DDTI-114	2184	08/00>01/03	5079.82	
Bluebird					
1.6	CA16S	1598	10/83>12/90	5971.82	
	CA16S	1598	12/85>12/90	5971.88	
	L16	1595	04/80>03/84	5971.88	
1.8	CA18DE / ET / S / T	1809	10/83>12/90	5971.88	
	CA18ET / CA18N / S	1809	10/83>07/87	5971.82	
	CA18ET / CA18S	1809	10/83>07/87	1378.77	
	L18S	1770	04/80>03/84	5971.88	
2.0	CA20E / CA20S	1973	12/85>12/90	5971.88	
	CA20S	1973	10/83>12/90	1378.77	
	CA20S	1973	10/83>12/90	5971.82	
2.0 D	LD20 / LD20T	1952	04/80>	1419.82	
Cedric					
2.0	CA20S	1973	10/83>06/88	5971.82	
2.0 200C	L20	1998	09/74>06/79	1378.77	
	L20	1998	09/74>06/79	5971.82	
2.2 D 220C	SD22	2164	09/74>06/79	1378.77	
	SD22	2164	09/74>06/79	5971.82	
2.3 D	SD23	2289	10/83>06/88	5792.76	
2.4 240C	L24	2393	05/79>09/83	5971.82	
2.6 260C	L26	2565	09/74>06/77	1378.77	
	L26	2565	09/74>06/77	5971.82	
2.8 280C	L28	2753	06/77>05/79	1378.77	
	L28	2753	06/77>09/83	5971.82	
	L28	2753	05/79>09/83	5971.88	
2.8 D 280D	LD28	2793	05/79>06/88	1419.82	
3.0	VG30E / VG30S	2960	10/83>06/88	6851.76	
					











LISTE D'APPLICATIONS

APPLICATION LIST/ANWENDUNGSLISTE

Thermostats



Nissan

VEHICULE MODEL FAHRZEUGTYP	MOTEUR ENGINE MOTOR	CYLINDRÉE ENGINE SIZE HUBRAUM	ANNÉE YEAR JAHR	VERNET	PHOTOS PICTURES ZEICHUNGEN
Cherry					
1.0	A10	988	10/78>07/83	5971.88	 1290
	E10	988	04/82>12/86	1378.77	
	E10	988	04/82>12/86	5971.82	
	E10	988	04/82>12/86	5971.88	
1.0 100A	A10	988	04/71>07/83	1378.77	 1419
	A10	988	04/71>04/76	1378.83	
	A10	988	04/71>07/83	5971.82	
1.2	A12	1171	10/78>07/83	5971.88	 3328
1.2 120A	A12	1171	01/74>07/83	1378.77	
	A12	1171	01/72>04/76	1378.83	
A12	1171	01/74>07/83	5971.82		
1.3	E13	1270	04/82>12/86	1378.77	 5792
	E13	1270	04/82>12/86	5971.82	
	E13	1270	04/82>12/86	5971.88	
1.4	A14	1397	08/90>07/83	1290.82	 5971
	A14	1397	08/80>07/83	1378.77	
	A14	1397	08/80>07/83	5971.88	
1.5	E15	1488	04/82>12/86	1378.77	 6313
	E15	1488	04/82>12/86	5971.88	
1.5 / Turbo	E15 / E15T	1488	04/82>12/86	5971.82	 6314
1.6	E16	1597	06/85>02/87	5971.88	
1.7 D	CD17	1681	10/82>12/86	6314.82	 6851
King Cab					
2.4 4WD	KA24E-1	2389	02/98>	6314.76	 6860
2.5 TD / TDi	TD25 / TD25TI	2494	02/98>	1419.82	
	TD25 / TD25TI	2494	02/98>	5792.76	
Laurel					
2.0	L20	1973		5971.88	
2.4	L24	2388		5971.88	
2.8 D	LD28	2800		1419.82	
Maxima					
2.0 QX	VQ20DE	1995	10/94>	6860.82	
3.0	VG30E	2960	12/88>09/94	6851.76	
	VG30E	2960	12/88>09/94	6851.82	
3.0 QX	VQ30DE	2998	10/94>	6860.82	
Micra					
1.0	CG10DE	998	01/03>	1290.88	
	CG10DE	998	08/92>06/00	6313.82	
	CG10DE	998	08/92>12/02	6313.88	
	MA10 / S	988	11/82>11/92	3328.88	
1.2	CG12DE	1240	01/03>	1290.88	
	MA12	1235	07/86>11/92	3328.88	
1.3	CG13DE	1275	08/92>06/00	6313.82	
	CG13DE	1275	08/92>06/00	6313.88	
1.4	CGA3	1348	07/00>12/02	6313.88	
	CGA3DE	1386	01/03>	1290.88	



LISTE D'APPLICATIONS

APPLICATION LIST/ANWENDUNGSLISTE

VEHICULE MODEL FAHRZEUGTYP	MOTEUR ENGINE MOTOR	CYLINDRÉE ENGINE SIZE HUBRAUM	ANNÉE YEAR JAHR	VERNET	PHOTOS PICTURES ZEICHNUNGEN
...Micra					
1.5 D	VJZ / VJX / TD15	1527	04/98>12/02	1542.89	 1290
1.5 DCi	K9K.7	1461	01/03>	6666.89	 1378
Micra II					
1.0	CR10DE	998	01/03>	1290.88	 1538
1.2	CR12DE	1240	01/03>	1290.88	 1542
1.4	CR14DE	1386	09/05>	1290.88	 5971
1.5 DCi	K9K.7	1461	01/03>	6666.89	 6295
1.6	HR160E		09/05>	6949.82	 6319
Murano NEW					
3.5 V6	VQ35DE	3499	09/05>	6982.00	 6583
Note NEW					
1.4	CR14DE	1399	03/06>	1290.88	 6666
1.5 DCi	K9K	1499	03/06>	6703.83	 6703 NEW
1.6	HR160E	1599	03/06>	6949.82	 6851
Pathfinder					
2.4 4WD	Z24	2389	08/86>04/92	5971.88	 6860
2.5 DCi	YD25DDTI		09/05>	6583.82	 6949 NEW
3.3 4WD V6	VG33E	3275	10/97>	6851.82	 6982 NEW
4.0 V6	VQ40DE		09/05>	6860.82	
Patrol					
2.8	L28	2753	11/84>02/89	5971.82	
	L28	2753	07/80>02/89	5971.88	
2.8 D / TD	A428-II / T	2820	03/89>03/96	1538.82	
2.8 D / TD GR	RD28 / T / TI	2826	09/88>07/04	6851.82	
3.0	RB30S	2962	03/89>03/96	6851.76	
3.0 TDi	ZD30DDTI / E4	2953	02/00>	6295.82	
3.3 D / TD	SD33 / SD33T	3246	07/80>02/89	6319.82	
4.2 GR	TB42E	4169	09/88>09/97	6851.82	
Pick-up					
1.5	J15	1483	09/79>11/81	1378.77	
1.6	J16	1567	09/79>08/85	5971.82	
1.8	L18	1770	09/79>08/85	5971.82	
	L18	1770	07/80>08/85	5971.88	
2.0	Z20	1952	09/85>05/94	5971.88	
2.2	Z22	2118	04/83>08/85	1378.77	
	Z22	2118	04/83>08/85	5971.88	



LISTE D'APPLICATIONS

APPLICATION LIST/ANWENDUNGSLISTE











VEHICULE MODEL FAHRZEUGTYP	MOTEUR ENGINE MOTOR	CYLINDRÉE ENGINE SIZE HUBRAUM	ANNÉE YEAR JAHR	VERNET
...Pick-up				
2.2 D	SD22	2164	09/79>03/83	1419.82
	SD22	2164	09/79>12/82	6319.88
2.3 D	SD23	2289	02/83>08/85	1419.82
	SD23	2289	02/83>10/87	6319.88
2.4	KA24E	2389	04/92>02/98	6314.76
	Z24 / Z24E	2389	09/85>04/92	5971.88
2.5 D	SD25	2488	04/83>08/85	1419.82
	SD25	2488	04/83>10/87	6319.88
	TD25	2494	10/87>02/98	6319.88
3.0	Z30	2998	09/85>02/98	5971.82
Prairie				
1.5	E15S	1488	09/82>09/88	5971.82
	E15S	1488	09/82>09/88	5971.88
1.8	CA18 / CA18S	1809	09/82>09/88	5971.82
	CA18 / CA18S	1809	09/82>09/88	5971.88
2.0	CA20E / CA20S	1973	01/86>03/92	5971.88
	CA20S	1973	01/86>09/88	5971.82
2.4	KA24E	2389	04/92>07/94	6314.76
	KA24E	2389	04/92>07/94	6314.82
Primera				
1.6	GA16DE	1596	03/02>	5079.82
	GA16DEB / DEF / DS	1597	02/90>02/02	5079.82
	GA16DEC	1597	04/93>05/96	3357.82
	GA16DS	1597	07/90>04/93	5079.76
1.8	QG18DE	1769	06/99>	5079.82
1.9 DCi	F9Q	1870	01/03>	6454.89
2.0	QR20DE	1998	07/90>	6314.82
		1998	02/90>02/02	6314.82
2.0 D	CD20	1974	07/90>05/96	6295.88
2.0 TD	CD20T	1974	06/96>02/02	6295.82
2.2 DCi	YD22DDT	2184	02/02>	6583.82
Primera II				
1.6	QG16DE	1597	03/02>	5079.82
1.8	QG18DE	1769	03/02>	5079.82
1.9 DCi	F9Q.7.60	1870	02/02>	6454.83
	F9Q.7.60	1870	02/02>	6454.89
2.0	QR20DE	1998	03/02>	6314.82
2.2 DCi	Y22DTI	2184	02/02>	6583.82
Pulsar				
1.0	E10	988	04/82>07/86	5971.82
1.3	E13	1270	04/82>07/86	5971.82
1.5 / Turbo	E15 / E15T	1488	04/82>07/86	5971.82
1.7 D	CD17	1681	10/82>07/86	6314.82
Serena				
1.6	GA16DEE	1597	07/92>	5079.82
2.0	SR20DEA	1998	07/92>	6314.76
2.0 D	LD20	1952	07/92>09/94	6319.88
2.3 D	LD23	2283	09/94>	6319.88
Silvia				
1.8	CA18ET / L18E	1809	02/78>08/88	5971.88
	L18E	1770	02/78>09/83	5971.82
2.0	CA20E	1973	10/83>08/88	5971.82
	FJ20E	1990	12/81>08/88	5971.82
	FJ20E	1990	10/83>08/88	5971.88





LISTE D'APPLICATIONS

APPLICATION LIST/ANWENDUNGSLISTE

VEHICULE MODEL FAHRZEUGTYP	MOTEUR ENGINE MOTOR	CYLINDRÉE ENGINE SIZE HUBRAUM	ANNÉE YEAR JAHR	VERNET	PHOTOS PICTURES ZEICHUNGEN
Stanza					
1.6	CA16S	1598	08/81>12/85	5971.88	 1378
1.7 D	CD17	1681	01/84>12/85	6314.82	 3357
1.8	CA18S	1809	08/81>12/85	5971.88	
Sunny					
1.0	E10S	988	06/86>10/88	1378.77	
	E10S	988	06/86>10/88	5971.82	
	E10S	988	06/86>10/88	5971.88	
1.2	A12	1171	05/73>08/78	5971.88	
1.3	E13S	1270	06/86>07/90	1378.77	
	E13S	1270	06/86>07/90	5971.82	
	E13S	1270	06/86>07/90	5971.88	
1.4	GA14DE / DS	1392	10/92>05/95	3357.82	 5079
	GA14DS / S	1392	10/88>10/92	5079.76	 5792
1.5	E15S	1488	06/86>10/88	1378.77	
	E15S	1488	06/86>10/88	5971.82	
	E15S	1488	06/86>10/88	5971.88	
1.6	CA16D / E16I / E16S	1598	06/86>07/90	5971.82	
	CA16D / E16I / E16S	1598	06/86>10/88	5971.88	
	CA16D / E16S	1598	06/86>10/88	1378.77	 5971
	GA16DE / DEE / DS	1597	10/90>12/96	3357.82	 6295
	GA16S / DS / I	1597	10/88>12/96	5079.76	
1.7 D	CD17	1681	07/95>04/96	6295.88	
	CD17	1681	06/86>10/90	6314.76	 6297
	CD17	1681	06/86>07/95	6314.82	 6314
1.8 16V	CA18D	1809	10/88>07/90	1378.77	
	CA18D	1809	10/88>07/90	5971.82	
	CA18D	1809	10/88>07/90	5971.88	
2.0	SR20DEB	1998	10/92>05/95	6314.82	
	SR20DEB / DET	1998	10/90>05/95	6314.76	
2.0 D	CD20	1974	10/90>10/92	6295.76	
	CD20	1974	10/90>12/96	6295.82	 6319
	CD20	1974	10/90>04/96	6295.88	 6851
Terrano					
2.4	KA24E-1	2389	03/93>	6314.76	
	KA24E-1	2389	05/96>	6314.82	
	Z24I	2389	08/87>02/93	5971.88	
2.7 Di / TDi	TD27Ti	2664	05/96>	6319.88	
2.7 TD	TD27T	2663	03/93>	6319.88	
2.7 TD 4WD	TD27 / TD27T	2663	08/87>01/98	6319.82	
3.0	VG30	2960	01/90>02/93	6851.76	
3.0 Di	ZD30 / TI	2953	02/02>	6295.82	
X-Trail					
2.0 4x4 16V	QR20DE	1998	06/01>	6314.82	
2.2 Di / DCi 4x4	YD22ETI / 114	2184	06/01>	6297.82	
2.2 VDi 4x4 16V	YD22DDTi	2184	01/04>	6297.82	
2.5 4x4 16V	QR25DE	2488	01/04>	6314.82	
NISSAN 					
Cabstar					
2.0	Z20	1952	07/82>05/94	5971.88	
2.3 D	TD23	2289	05/87>05/94	6319.82	
2.5 D	SD25	2488	07/85>10/86	5792.76	
	SD25	2488	07/85>10/86	6319.82	



LISTE D'APPLICATIONS

APPLICATION LIST/ANWENDUNGSLISTE



















VEHICULE MODEL FAHRZEUGTYP	MOTEUR ENGINE MOTOR	CYLINDRÉE ENGINE SIZE HUBRAUM	ANNÉE YEAR JAHR	VERNET
Interstar				
1.9 DCi / Combi	F9Q.7.72	1870	09/02>11/03	6454.83
2.2 DCi	G9T.7.22	2188	09/00>11/03	6970.83
2.5 CDI	G9U.7.20	2463	09/02>11/03	6970.83
Kubistar				
1.2 E	D4F / D7F	1149	09/03>	6126.89
1.5 DCi	K9K / K9K.7	1461	09/03>	6666.89
Primastar				
1.9 DCi	F9Q.7.60	1870	09/02>	6454.83
	F9Q.7.60	1870	09/02>	6454.89
Trade				
2.0 D	LD20-II	1952	04/93>	6963.81
2.8 D	A428-II	2820	12/86>06/94	1538.82
3.0 D	BD30	2953	04/93>	1538.82
	BD30-II	2953	06/94>12/94	6319.82
	BD30-II / BD30-TI	2953	01/95>	5079.82
Vanette				
1.5	A15	1487	01/86>11/94	5971.88
	A15 / A15S	1487	03/82>03/93	5971.82
1.6 Cargo	GA16DEE	1597	07/92>	5079.82
2.0	Z20S	1952	09/86>03/93	1378.77
	Z20S	1952	09/86>03/93	5971.88
2.0 D	LD20	1952	09/86>03/93	1419.77
	LD20	1952	11/82>03/93	1419.82
	LD20 / LD20-II	1952	09/86>11/94	6963.81
2.0 D Cargo	LD20	1952	07/92>08/94	6319.88
2.3 D Cargo	LD23	2283	09/94>	6319.88
2.4	Z24I	2389	09/86>03/93	5971.88
Urvan				
2.3 D	TD23	2289	02/87>12/88	6319.82
2.4	Z24I	2389	05/89>11/95	5971.88
2.5 D	TD25-80	2494	12/88>05/97	6319.82
	TD25-80	2494	12/88>05/97	6319.88
OPEL				
Agila				
1.0	Z10XE	973	03/00>07/03	6951.92
	Z10XEP	998	08/03>	6951.92
1.2	Z12XE	1199	03/00>08/04	6951.92





LISTE D'APPLICATIONS

APPLICATION LIST/ANWENDUNGSLISTE

VEHICULE MODEL FAHRZEUGTYP	MOTEUR ENGINE MOTOR	CYLINDRÉE ENGINE SIZE HUBRAUM	ANNÉE YEAR JAHR	VERNET	PHOTOS PICTURES ZEICHNUNGEN
...Agila					
1.3 CDTi	Z13DT	1248	08/03>	6835.88	 1335
Arena					
1.9 D	F8Q.6.00 / .6.06	1870	01/98>08/01	6320.89	 1378
	F8Q.6.06	1870	01/98>	6045.89	
2.5 D	S8U.7.58 / .7.80 / .7.82	2445	01/98>08/01	5898.76	
Ascona B					
1.2	12N / 12S	1196	08/75>07/79	4898.92	 1439
1.3	13N / 13S	1297	03/79>07/81	4898.92	 4898
1.6	16N / 16S	1584	08/75>	1378.88	
	16N / 16S	1584	08/75>07/81	4898.92	
1.9	19N	1897	08/75>	1378.88	 5898
	19N	1897	08/75>07/81	4898.92	 5979
2.0	20E	1979	01/80>07/81	6248.87	
	20S	1979	08/78>	1378.88	
	20S	1979	08/78>07/81	4898.92	
2.0 D	20D	1998	08/78>07/81	1439.92	
Ascona C					
1.3	13N / 13S	1297	08/81>08/88	4898.92	 5980
1.6	16SH / 16N	1598	08/81>08/88	1335.92	 6045
	16SH / 16N	1598	08/81>08/88	6287.92	
	C16NZ / E16NZ / 16SV	1598	08/86>08/88	4898.92	
1.6 D	1600D	1598	08/81>08/88	1335.92	 6171
1.8	18E / C18NE	1796	08/81>08/87	1335.92	 6237
	E18NV / S18NV	1796	08/86>08/88	6287.92	
2.0	20NE / 20SEH / C20NE	1998	08/85>08/88	5979.92	
2.0 D	20D	1998	08/75>07/81	1439.92	
Astra F					
1.4	14NV / 14SE / X14NZ	1389	09/91>01/98	4898.92	 6248
	C14NV / C14NZ / C14SE	1389	09/91>02/01	4898.92	 6286
1.4 16V	X14XE	1389	07/95>02/01	6171.92	
1.6	16LZ2	1598	09/91>01/98	6501.82	
	C16NZ / C16SE	1598	09/91>02/01	4898.92	 6287
	X16SZ / X16SZR	1598	09/91>02/01	4898.92	 6320
	X16XEL	1598	06/94>02/01	6171.92	
1.7 D	17D / 17DR	1699	09/91>01/98	1335.92	
1.7 TD	17TD	1686	09/91>	5980.88	
	17TD / X17DTL	1686	09/91>01/98	1335.92	
1.8	C18NZ	1796	09/91>08/94	6286.92	 6501
	C18XE / C18XEL	1799	08/94>02/01	6237.92	 6835



LISTE D'APPLICATIONS

















APPLICATION LIST/ANWENDUNGSLISTE

VEHICULE MODEL FAHRZEUGTYP	MOTEUR ENGINE MOTOR	CYLINDRÉE ENGINE SIZE HUBRAUM	ANNÉE YEAR JAHR	VERNET	PHOTOS PICTURES ZEICHUNGEN
...Astra F					
1.8 16V	C18XE / C18XEL	1799	07/93>	6222.92	 1335
	X18XE	1799	08/94>	6222.92	 4898
	X18XE	1799	07/95>02/01	6237.92	 6171
2.0	C20NE	1998	09/91>02/01	6286.92	 6222
	C20NE	1998	09/91>02/01	6501.82	 6237
	C20NE	1998	09/91>02/01	6501.92	 6251
2.0 16V	C20XE	1998	07/94>01/98	6287.82	 6286
	X20XEV	1998	07/94>01/98	6237.92	 6287
Astra G					
1.2 16V	X12XE	1199	02/98>02/04	6251.92	 6501
1.4	X14NZ	1389	09/98>	4898.92	 6517
	Z14XE	1389	02/98>02/04	6856.92	 6518
1.4 16V	X14XE	1389	02/98>02/04	6519.92	 6519
1.6	X16SZR / Z16SE	1598	02/98>	4898.92	 6856
	X16XEL	1598	09/98	6171.92	 6858
	Z16XE / Z16YNG	1598	02/98>12/05	6856.92	
1.6 16V	C16SEL / X16XEL	1598	02/98>02/04	6519.92	
1.7 DTi / CDTi	Y17DT / Z17DTL	1686	02/00>02/04	6858.89	
1.7 TD	X17DTL	1686	02/98>08/00	1335.92	
1.8 / 16V	X18XE1 / Z18XE / Z18XEL	1796	02/98>	6517.92	
2.0 Di / DTi	X20DTL / Y20DTL	1995	02/98>	6518.92	



LISTE D'APPLICATIONS

APPLICATION LIST/ANWENDUNGSLISTE

VEHICULE MODEL FAHRZEUGTYP	MOTEUR ENGINE MOTOR	CYLINDRÉE ENGINE SIZE HUBRAUM	ANNÉE YEAR JAHR	VERNET	PHOTOS PICTURES ZEICHNUNGEN
...Astra G					
2.0 DTi	Y20DTH	1995	08/99>02/04	6853.92	
	Y20DTH	1995	08/99>	6854.92	
2.0 Turbo / Turbo 16V	X20XER / X20EV	1998	02/98>09/02	6237.92	
	Z20LER / Z20LET	1998	02/00>06/05	6237.92	
2.2 16V	Z22SE	2198	10/99>12/05	6883.82	
2.2 DTi 16V	Y22DTH / Y22DTR	2171	03/01>12/05	6853.92	
Astra H					
1.4	Z14XEP	1364	03/04>	6251.92	
1.7 CDTi	Z17DTH / Z17DTL	1686	03/04>	6858.89	
1.8	Z18XE	1796	03/04>	6517.92	
1.9 CDTi	Z19DTH / Z19DTL	1910	07/04>06/05	6978.88	
2.0	Z20LEL / Z20LER	1998	03/04>	6237.92	
Calibra					
2.0	C20NE	1998	09/89>07/97	5979.92	
2.0 16V	C20LET / C20XE	1998	09/89>07/97	6287.82	
	C20LET / C20XE	1998	09/89>07/97	6287.92	
	X20XEV	1998	06/94>	6222.92	
2.5 V6	X20XEV	1998	06/94>07/97	6237.92	
	C25XE / X25XE	2498	05/93>	6249.92	
Corsa A					
1.0	10N / 10S	993	10/82>10/93	4898.92	
1.2	12NC / E12GV	1195	01/85>10/89	4898.92	
	12NV / 12ST / C12NZ	1195	10/82>10/93	4898.92	
1.3	13SB / C13N	1297	10/82>09/90	4898.92	
1.4	14NV / C14NZ / C14SE	1389	09/89>10/93	4898.92	
1.5 D	4EC1	1488	09/87>10/93	1290.88	
1.5 TD	T4EC1	1488	03/88>10/93	5980.88	
1.6	C16NZ / C16SE / E16SE	1598	03/88>10/93	4898.92	
Corsa B					
1.0 12V	X10XE	973	03/97>08/00	6251.92	
1.2	12NZ / C12NZ / X12SZ	1195	03/93>08/00	4898.92	
	X12XE	1199	03/98>08/00	6251.92	
1.4	C14NZ / C14SE / X14SZ	1389	03/93>08/00	4898.92	



LISTE D'APPLICATIONS

APPLICATION LIST/ANWENDUNGSLISTE















VEHICULE MODEL FAHRZEUGTYP	MOTEUR ENGINE MOTOR	CYLINDRÉE ENGINE SIZE HUBRAUM	ANNÉE YEAR JAHR	VERNET
...Corsa B				
1.4 16V	X14XE	1389	07/95>08/00	6171.92
1.5 D (N° Moteur 00544012)	15D	1488	03/93>	5980.88
1.5 D (N° Moteur 00544013)	15D	1488	03/93>08/00	6252.85
1.5 TD (N° Moteur 00544012)	15TD	1488	03/93>	5980.88
1.5 TD (N° Moteur 00544013)	15TD	1488	03/93>08/00	6252.85
1.6 16V	C16XE	1598	03/93>08/00	6171.92
1.7 D	17DA / X17D	1699	03/93>08/00	6252.85
Corsa C				
1.0 12V	Z10XE / Z10XEP	998	09/00>	6251.92
1.2 16V	Z12XE / Z12XEP	1229	09/00>	6251.92
1.3 CDTi	Z13DT	1248	09/03>	6835.88
	Z13DT	1248	09/03>	6858.89
1.4 16V	Z14XE / Z14XEP	1389	09/00>	6856.92
1.7 CDTi	Z17DTH	1686	09/03>	6858.89
1.7 Di 16V / DTi 16V	Y17DT / Y17DTL	1686	09/00>08/03	6858.89
1.8 16V	Z18XE	1796	09/00>	6517.92
Frontera				
2.0 4x4	C20NE / X20SE	1998	03/91>09/98	5979.92
2.2 4x4 16V	X22SE / Y22SE	2198	10/98>	6222.92
	X22XE	2198	04/95>09/98	6222.92
2.3 TD 4x4	23DTR	2260	03/91>04/95	1439.92
2.4 4x4	C24NE	2410	03/91>04/95	1439.92
2.5 TDS	25TDS	2499	06/96>09/98	5963.80
2.8 TDi 4x4	4JB1-TC	2771	05/95>07/96	6252.82
Kadett C				
1.0	10N / 10S	993	08/73>07/79	4898.92
1.2	12N / 12S	1196	08/73>07/79	4898.92
1.6	16S	1584	10/77>07/79	1378.88
1.9	19E	1897	08/75>12/77	1439.80
2.0	20E	1979	10/77>07/79	1439.80
Kadett D				
1.0	10N / 10S	993	08/79>07/82	4898.92
1.2	12N / 12S	1196	08/79>07/84	4898.92
1.3	13N / 13S	1297	08/79>08/84	4898.92





LISTE D'APPLICATIONS















APPLICATION LIST/ANWENDUNGSLISTE

VEHICULE MODEL FAHRZEUGTYP	MOTEUR ENGINE MOTOR	CYLINDRÉE ENGINE SIZE HUBRAUM	ANNÉE YEAR JAHR	VERNET	PHOTOS PICTURES ZEICHNUNGEN
...Kadett D					
1.6	16SH	1598	09/81>08/84	1335.92	
1.6 D	D16	1598	04/82>08/84	1335.92	
1.8	18E	1796	05/83>08/84	1335.92	
Kadett E					
1.2	12S / 12SC	1196	08/84>12/91	4898.92	
1.3	13N / 13S / C13N	1297	08/84>12/91	4898.92	
1.4	14NV / C14NZ / E14LV	1389	09/89>12/91	4898.92	
1.5 D / TD	TC4EC1	1488	09/88>12/91	5980.88	
1.6	16S / 16SV / E16NZ	1598	08/84>12/91	1335.92	
	C16LZ / C16NZ / E16NZ	1598	09/86>09/91	4898.92	
1.6 D	16D	1598	08/84>10/89	1335.92	
1.7 D	17DV	1699	01/89>12/91	1335.92	
1.8	18E / 18SE	1796	08/84>12/91	1335.92	
	C18NE / C18NZ / S18NV	1796	09/86>12/91	1335.92	
2.0	20NE / 20SEH / 20XE	1998	09/86>12/91	6287.92	
	C20NE / C20XE	1998	09/86>12/91	6287.92	
Manta B					
1.2	12N / 12S	1196	08/75>07/79	4898.92	
1.3	13N / 13S	1297	03/79>07/86	4898.92	
1.6	16N / 16S	1584	08/75>	1378.88	
	16N / 16S	1584	08/75>07/81	4898.92	
1.8	18S	1796	03/82>07/86	1335.92	
1.9	19N	1897	08/75>07/81	4898.92	
	19N / 16S	1897	08/75>	1378.88	
2.0	20E	1979	12/77>08/88	6248.87	
	20S	1979	12/77>	1378.88	
	20S	1979	12/77>07/84	4898.92	
Meriva					
1.3 CDTi	Z13DT	1248	08/03>	6835.88	
1.4	Z14XEP	1364	09/04>	6251.92	
1.6	Z16SE	1598	05/03>08/04	4898.92	
	Z16XE	1598	05/03>	6856.92	
1.7 CDTi / DTi	Y17DT / Z17DTH	1686	05/03>	6858.89	
1.8	Z18XE	1796	05/03>	6517.92	
Monterey					
3.1 TD	C4JG	3059	09/91>03/93	6252.82	
	C4JG	3059	04/93>06/98	5971.82	
Monza					
2.0	20E	1979	12/82>07/84	6248.87	
2.2	22E	2197	08/84>08/86	1439.92	
2.5	25E	2490	06/81>08/86	1439.92	
2.8	28H	2784	06/78>05/81	1378.88	
2.8 (A/C)	28H	2784	06/78>05/81	6248.87	
3.0	30E / C30NE	2968	06/81>08/86	1439.92	
Omega A					
1.8	18NV / 18SV / S18NV	1796	10/86>07/91	5979.92	
	18SEH / E18NVR	1796	10/86>02/94	5979.92	
2.0	20SE / C20NE	1998	10/86>02/94	5979.92	
2.3 D	23YD	2260	10/86>02/94	1439.92	
2.3 TD	23DTR / 23YDT	2260	10/86>02/94	1439.92	
2.4	C24NE	2410	10/88>07/91	1439.80	
	C24NE	2410	10/88>07/91	1439.92	
2.6	C26NE	2594	08/90>02/94	1439.92	



LISTE D'APPLICATIONS





APPLICATION LIST/ANWENDUNGSLISTE

VEHICULE MODEL FAHRZEUGTYP	MOTEUR ENGINE MOTOR	CYLINDRÉE ENGINE SIZE HUBRAUM	ANNÉE YEAR JAHR	VERNET	PHOTOS PICTURES ZEICHNUNGEN
...Omega A					
3.0	30NE	2968	02/87>07/91	1439.80	
	30NE	2968	02/87>07/91	1439.92	
	C30LE / C30NE / C30SE	2968	02/87>02/94	1439.92	
Omega B					
2.0	20SE / X20SE	1998	02/94>07/03	5979.92	
2.0 16V	X20XEV	1998	02/94>07/03	6237.92	
2.0 DTi	X20DTH	1995	09/97>09/00	6516.92	
2.2	Z22XE	2198	08/99>07/03	6237.92	
2.5 TD	U25TD / X25TD	2497	02/94>07/03	5973.80	
2.5 V6	X25XE	2498	02/94>	6249.92	
3.0 V6	X30XE	2962	02/94>	6249.92	
Rekord D					
1.7	17L / 17N / 17S	1698	01/72>08/77	1378.88	
	17L / 17N / 17S	1698	01/72>08/77	5962.92	
1.9	19N / 19S / 19SH	1897	01/72>08/77	1378.88	
	19N / 19S / 19SH	1897	01/72>08/77	5962.92	
2.0	20S	1979	09/75>08/77	1378.88	
	20S	1979	09/75>08/77	5962.92	
2.0 D	20D	1998	08/74>08/77	1439.92	
2.1 D	21D	2068	09/72>	1439.80	
	21D	2068	09/72>08/77	1439.92	
Rekord E					
1.8	18N / 18S / C18NV	1796	10/82>09/86	1335.92	
1.9	19N	1897	08/77>09/82	6248.87	
2.0	20E	1979	08/77>09/86	1439.92	
	20E / 20S	1979	08/77>09/86	6248.87	
2.1 D	21D	2068	08/77>07/78	1439.92	
2.2	22E	2197	08/84>09/86	1439.92	
2.3 D	23D	2260	08/78>09/86	1439.92	
2.3 TD	23TD	2260	08/84>09/86	1439.92	
Senator A					
2.0	20E	1979	12/82>07/84	6248.87	
2.2	22E	2197	08/84>02/87	1439.92	
2.3 TD	23TD	2260	08/84>02/87	1439.92	
2.5	25E	2490	06/81>02/87	1439.92	
2.8	28H	2784	06/78>10/81	1378.88	
	28H	2784	06/78>10/81	6248.87	
3.0	30E / C30NE	2968	06/78>02/87	1439.92	
Senator B					
2.5	25N	2490	02/87>08/90	1439.80	
2.6	C26NE	2594	08/90>06/93	1439.80	
3.0	30NE	2968	02/87>06/93	1439.80	
	C30LE / C30NE / C30SE	2968	02/87>06/93	1439.80	
Signum					
1.8 16V	Z18XE	1796	06/03>	6517.92	
1.9 CDTi	Z19-100 / Z19DTH / Z19DTL	1910	10/05>	6978.88	
	Z19DTH / Z19DTL	1910	04/04>	6978.88	
2.0	Z20NET	1998	06/03>	6883.82	
2.0 DTi 16V	Y20DTH	1995	06/03>09/05	6857.92	
2.0 Turbo 16V	Z20NET	1998	06/03>	6883.82	
2.2 DIG	Z22YH	2198	06/03>	6883.82	
2.2 DTi 16V	Y22DTR	2171	06/03>09/05	6857.92	
3.0 CDTi V6 24V	Y30DT	2958	06/03>	6297.82	



LISTE D'APPLICATIONS

APPLICATION LIST/ANWENDUNGSLISTE

VEHICULE MODEL FAHRZEUGTYP	MOTEUR ENGINE MOTOR	CYLINDRÉE ENGINE SIZE HUBRAUM	ANNÉE YEAR JAHR	VERNET	PHOTOS PICTURES ZEICHNUNGEN
...Signum					
3.2 V6 24V	Z32SE	3175	06/03>09/05	6249.92	 1335
Sintra					
2.2	X22XE	2198	03/96>12/99	6237.92	 4898
3.0 V6	X30XE	2962	03/96>12/99	6249.92	
Speedster NEW					
2.0	Z20LET	1998	03/03>09/05	6237.92	 5979
2.2	Z22SE	2198	08/00>09/05	6883.82	 5980
Tigra					
1.3 CDTi	Z13DT	1248	07/04>	6835.88	
1.4	C14SE	1389	08/97>01/01	4898.92	
1.4 16V	X14XE	1389	10/94>01/01	6171.92	 6171
1.6 16V	C16SEL / X16XE	1598	10/94>01/01	6171.92	 6237
1.8	Z18XE	1796	07/04>	6517.92	
Vectra A					
1.4	14NV	1389	09/88>07/92	4898.92	
1.6	16LZ2 / 16SV / C16NZ	1598	09/88>09/95	4898.92	 6249
	C16NZ2 / E16NZ / X16SZ	1598	09/88>09/95	4898.92	 6252
1.7 D	17D / 17DR	1699	09/88>09/95	1335.92	
1.7 TD	17TD	1686	07/91>09/95	5980.88	
1.8	18SV / C18NZ / E18NVR	1796	09/88>09/95	5979.92	
2.0	20NE / 20SEH	1998	09/88>07/93	5979.92	 6287
	C20NE	1998	09/88>09/95	5979.92	 6516
2.0 16V	20XE / C20LET / C20XE	1998	03/90>09/95	6287.92	
	X20XEV	1998	09/93>09/95	6237.92	
2.0 DTi 16V	Y20DTH	1995	04/02>	6857.92	 6517
2.5 V6	C25XE / X25XE	2498	05/93>	6249.92	 6835
Vectra B					
1.6	16LZ2	1598	10/95>01/99	5979.82	
	16SV / C16NZ / E16NZ	1598	09/98>09/95	4898.92	
	X16SZR	1598	10/95>01/99	4898.92	
1.6 16V	X16XEL	1598	10/95>01/99	6171.92	
	Z16XE	1598	02/99>06/03	6856.92	 6856
1.7 TD	X17DT	1686	10/95>01/99	6252.85	 6857
1.8	Z18XE	1796	02/09>06/03	6883.82	
1.8 16V	X18XE	1799	10/95>01/99	6237.92	
	Z18XE	1799	02/99>	6517.92	
2.0	20NE / 20NEJ / 20SEH	1796	09/88>01/99	5979.82	
	20NEJ	1998	10/95>01/99	5979.92	
2.0 16V	X20XEV	1998	10/95>01/99	6237.92	
2.0 Di 16V	X20DTL	1995	10/96>01/99	6516.92	 6883



LISTE D'APPLICATIONS

APPLICATION LIST/ANWENDUNGSLISTE

VEHICULE MODEL FAHRZEUGTYP	MOTEUR ENGINE MOTOR	CYLINDRÉE ENGINE SIZE HUBRAUM	ANNÉE YEAR JAHR	VERNET
...Vectra B				
2.0 DTi 16V	Y20DTH / X20DTH	1995	09/97>06/03	6855.92
2.2 16V	Z22SE	2198	02/99>06/03	6883.82
2.2 DTi 16V	Y22DTR	2171	09/00>06/03	6855.92
2.5	X25XE	2498	05/98>01/99	6883.82
2.5 V6	C25XE / X25XE	2498	10/95>01/99	6249.92
2.6 V6 24V	Y26SE	2597	09/00>03/06	6249.92
Vectra C				
1.6	Z16XE	1598	04/02>09/05	6856.92
1.8 16V / GTS / GPL	Z18XE / Z18XEL / Z18GPL	1796	04/02>09/05	6517.92
1.9 CDTi	Z19DTH	1910	04/04>09/05	6978.88
2.0 DTi	Y20DTH	1995	04/02>03/05	6857.92
2.0 Turbo 16V	Z20NET	1998	03/03>09/05	6883.82
2.2 16V	Z22SE / Z22YH	2198	04/02>09/05	6883.82
2.2 DTi 16V / GTS	Y22DTR	2171	04/02>09/05	6857.92
3.0 CDTi	Y30DT	2958	06/03>09/05	6249.92
3.2 V6 24V	Z32SE	3175	06/02>09/05	6249.92
Vectra D				
1.6	Z16XE	1598	10/05>	6856.92
1.8	Z18XE	1796	10/05>	6858.89
1.9 CDTi	Z19-100 / Z19DTH / Z19DTL	1910	10/05>	6978.88
2.0	Z20NET	1998	10/05>	6883.82
2.2	Z22YH	2198	10/05>	6883.82
3.0 CDTi	OPEL02	2958	10/05>	6297.82
Zafira				
1.6	Z16YNG	1598	07/03>06/05	6856.92
1.6 16V	X16XEL	1598	01/99>06/03	6519.92
	Z16XE	1598	01/99>06/05	6856.92
1.8 16V	X18XE1 / Z18XE	1796	01/99>	6517.92
1.9 CDTi	Z19-100 / Z19DTH / Z19DTL	1910	07/05>	6978.88
2.0 DT 16V	X20DTL	1995	01/99>	6518.92
2.0 DTi 16V	Y20DTH	1995	01/01>12/02	6854.92
	Y20DTH / Y20DTL	1995	01/99>	6518.92
	Y20DTH / Y20DTL	1995	01/01>06/03	6853.92
2.0 T 16V	Z20LET / Z20LER	1998	09/01>	6237.92
2.2 16V	Z22SE / Z22YH	2198	01/99>	6883.82
2.2 DTi 16V	Y22DTR	2171	07/03>06/05	6853.92
OPEL 				
Campo				
2.2 D	C233	2238	08/91>06/96	6252.82
2.3	4ZDI	2254	10/88>06/96	5971.82
2.5 TD / DTi	4JA-101 / 4JA1	2499	07/96>	6252.82
3.1 TD	C4JG	3059	04/93>06/96	5971.82
3.1 TD / TDS	4JG2 / C4JG	3059	10/88>	6252.82



5971



6237



6249



6252



6297



6517



6518



6519



6853



6854



6855



6856



6857



6858



6883

















6978

NEW



LISTE D'APPLICATIONS

APPLICATION LIST/ANWENDUNGSLISTE

VEHICULE MODEL FAHRZEUGTYP	MOTEUR ENGINE MOTOR	CYLINDRÉE ENGINE SIZE HUBRAUM	ANNÉE YEAR JAHR	VERNET	PHOTOS PICTURES ZEICHUNGEN
Combo					
1.2	12NZ / C12NZ / X12SZ	1195	03/93>09/01	4898.92	 4898
1.3	13N / 13S / C13N	1297	07/85>03/93	4898.92	 5980
1.3 CDTi	Z13DT	1248	07/04>	6835.88	 6045
1.4	14NV / E14LV	1389	09/89>03/93	4898.92	 6047
	C14NZ / C14SE / X14SZ	1389	09/89>09/01	4898.92	
	X14XE	1389	08/99>09/01	6171.92	
1.4	Z14XEP	1364	07/04>	6251.92	 6171
	Z14XEP	1364	07/04>	6856.92	 6251
1.6	C16LZ / E16NZ / Z16SE	1598	08/86>06/04	4898.92	
1.6 D	16D	1598	07/85>06/90	5980.88	
1.7 CDTi / Di / DTi	Y17DT / Y17DTL / Z17DTH	1686	10/01>	6858.89	 6252
1.7 D	17D	1699	08/90>03/93	5980.88	 6454
	17DA / X17D	1699	03/93>09/01	6252.85	
Movano					
1.9 Di	F9Q.7.70	1870	10/98>07/02	6045.89	 6581
	F9Q.7.70	1870	08/00>	6923.83	 6835
	F9Q.7.72	1870	08/00>07/02	6454.89	
2.2 CDTi / DTi	G9T	2188	09/00>	6970.83	 6856
2.5 CDTi	G9U	2463	10/01>	6970.83	 6858
2.5 D	S8U.7.72	2445	10/98>10/01	6581.82	
2.8 DTi	S9W.7.00 / S9W.7.02	2800	10/98>10/01	6581.82	 6923
Vivaro					
1.9 Di / DTi	F9Q.7.60 / F9Q.7.62	1870	05/01>	6454.89	 6970
2.0 16V	F4R.7.20	1998	05/01>	6047.89	
2.5 DTi	G9U.7.20 / G9U.7.30	2463	05/03>	6970.83	



LISTE D'APPLICATIONS

APPLICATION LIST/ANWENDUNGSLISTE

VEHICULE MODEL FAHRZEUGTYP	MOTEUR ENGINE MOTOR	CYLINDRÉE ENGINE SIZE HUBRAUM	ANNÉE YEAR JAHR	VERNET	PHOTOS PICTURES ZEICHNUNGEN
----------------------------------	---------------------------	-------------------------------------	-----------------------	--------	-----------------------------------

PEUGEOT



104					
1.0	XV3 / 5 / 8	954	07/72>06/87	1427.82	
	XV3 / 5 / 8	954	07/72>06/87	5108.83	
	XV3 / 5 / 8	954	07/72>06/87	6148.89	
1.1	XW3 / 7	1124	07/75>05/88	1427.82	
	XW3 / 7	1124	07/75>05/88	5108.83	
	XW3 / 7	1124	07/75>05/88	6148.89	
1.2	XZ5	1219	07/79>06/84	1427.82	
	XZ5	1219	07/79>06/84	5108.83	
	XZ5	1219	07/79>06/84	6148.89	
1.3	TU2	1294	06/93>03/96	6148.89	
1.4	XY6B / XY8 / XYR	1360	08/78>07/85	1427.82	
	XY6B / XY8 / XYR	1360	08/78>07/85	5108.83	
	XY6B / XY8 / XYR	1360	08/78>07/85	6148.89	
106					
1.0	TU9	954	09/91>07/03	6148.89	
1.1	TU1	1124	09/91>07/03	6148.89	
	TU1	1124	09/00>07/03	6191.89	
1.3	TU2	1294	06/93>03/96	6148.89	
1.4	TU3	1360	03/96>07/03	6148.89	
	TU3	1360	01/98>07/03	6191.89	
	TU3	1360	05/98>11/98	6106.89	
1.4 D	TUD3	1360	06/92>03/96	1542.89	
1.5 D	TUD5	1527	03/96>07/03	1542.89	
1.6	TU5	1587	03/93>07/03	6148.89	
107 / 1007 NEW					
1.0	384F(CFA)	998	06/05>	6950.82	
1.4	TU3JP	1360	04/05>	6488.89	
1.4 HDi	DV4TD	1399	04/05>	6874.83	
1.6	TU5JP4	1587	04/05>	6488.89	
204					
1.1	XK / XK4	1130	07/65>09/70	2150.75	
	XK4 / XK5	1130	10/70>06/77	1415.75	
1.2 D	XLD	1225	09/67>06/77	1415.75	
	XLD	1225	09/67>06/77	2150.75	
1.4 D	XLD4	1357	03/73>06/77	1538.82	
205					
1.0	TU9	954	08/87>09/98	6148.89	
	XV8	954	02/83>07/88	5108.83	
1.1	E1 / F1	1118	07/84>06/93	1418.83	
	TU1	1124	08/87>09/98	6148.89	
	XW7	1124	02/83>07/88	5108.83	
1.3	G1 / G1A	1294	07/84>06/93	1418.83	
	TU2	1294	08/87>06/93	6148.89	
1.4	TU3	1360	08/87>12/94	6148.89	
	XY6B / XY7 / XY8	1360	02/83>12/94	5108.83	
	Y2 / K	1442	07/84>07/87	1418.83	
1.6	J2	1592	07/84>06/93	1418.83	
	XU5	1580	02/83>09/98	5108.83	
	XU5	1580	08/87>09/98	5108.89	
	XU5	1580	08/87>09/98	6148.89	
1.7 D	XUD7	1769	08/83>07/90	4947.81	
	XUD7	1769	07/89>05/92	5231.83	
	XUD7	1769	05/92>09/98	5130.83	
1.7 TD	XUD7T	1769	10/90>09/98	5231.83	





LISTE D'APPLICATIONS



APPLICATION LIST/ANWENDUNGSLISTE

VEHICULE MODEL FAHRZEUGTYP	MOTEUR ENGINE MOTOR	CYLINDRÉE ENGINE SIZE HUBRAUM	ANNÉE YEAR JAHR	VERNET	PHOTOS PICTURES ZEICHNUNGEN
...205					
1.9	XU9	1905	02/83>09/98	5108.83	
	XU9	1905	08/89>09/98	5108.89	
	XU9	1905	08/87>09/98	6148.89	
1.9 D	XUD9	1905	08/89>05/92	5231.83	1415
	XUD9	1905	05/92>09/98	5130.83	1538
206 / 207					
1.1	TU1	1124	09/98>	6488.89	
	TU1	1124	09/05>	6808.103	
1.4	TU3 / ET3J4	1360	09/98>	6488.89	1542
1.4 HDi	DV4TD / L4	1398	03/02>	6874.83	2150
1.6	TU5	1587	09/98>	6488.89	
1.6 HDi	DV6TED4	1560	04/04>	6875.83	
1.8 D	DW8	1761	09/98>	5130.83	2620
1.9 D	DW8	1868	09/98>	5130.83	4945
2.0 16V	EW10	1997	09/99>	6332.89	
2.0 HDi	DW10	1997	09/99>	5130.83	
304					
1.1	XK5	1127	09/76>09/79	1415.75	4947
1.3	XL3	1288	07/69>09/70	2150.75	
	XL3 / XL5	1288	09/70>09/79	1415.75	
	XL5	1290	09/79>03/80	2620.82	5130
1.4 D	XL4D	1357	09/76>09/79	1538.82	5231
1.6 D	XIDL	1548	09/79>03/80	1542.82	
305					
1.1	XK5	1127	11/77>02/88	2620.82	
1.3	XL5	1290	11/77>06/90	2620.82	6148
1.5	XR5	1472	11/77>06/90	2620.82	
1.5 D	X1D	1548	11/77>07/82	1542.82	6332
1.6	XU5	1580	08/82>06/90	5108.83	
	XU5	1580	08/82>06/90	6148.89	
1.7 D	XUD7	1769	08/82>06/90	4945.89	6488
	XUD7	1769	08/82>06/90	4947.81	6808 NEW
1.9	XU9	1905	08/82>06/90	5108.83	
	XU9	1905	08/82>06/90	6148.89	
1.9 D	XUD9	1905	08/82>06/90	4945.89	6874
	XUD9	1905	08/82>06/90	4947.81	6875
306					
1.1	TU1	1124	02/93>02/97	6148.89	



LISTE D'APPLICATIONS



APPLICATION LIST/ANWENDUNGSLISTE

VEHICULE MODEL FAHRZEUGTYP	MOTEUR ENGINE MOTOR	CYLINDRÉE ENGINE SIZE HUBRAUM	ANNÉE YEAR JAHR	VERNET	PHOTOS PICTURES ZEICHNUNGEN	
...306						
1.4	TU3	1360	02/93>03/02	6148.89	 1418	
	TU3	1360	05/99>03/02	6191.89		 1529
1.6	TU5	1587	02/93>05/99	6148.89	 4885	
	TU5	1587	05/99>09/02	6191.89		 4949
	TU5	1587	01/00>09/02	6488.89		
1.8	XU7	1761	02/93>07/96	5108.89	 5108	
	XU7	1761	06/93>09/02	5108.83		 5130
1.8 16V	XU7	1761	03/97>09/02	4885.83	 5229	
1.8 D	XUD7	1769	06/93>02/02	5130.83		 5231
1.9 D	DW8	1868	11/98>03/02	5130.83	 6148	
1.9 D / SD	XUD9	1905	06/93>03/02	5130.83		 6191
1.9 TD	XUD9T	1905	06/93>02/97	5130.83	 6332	
2.0	XUD9T	1905	03/97>03/02	4885.83		 6488
	XU10	1998	06/93>07/96	5108.89	 6756	
	XU10	1998	09/93>02/97	5108.83		 6874
	XU10	1998	09/93>02/97	4885.89		
XU10	1998	03/96>09/02	4885.83			
2.0 HDi	DW10	1997	03/99>03/02	5130.83		
307						
1.4	TU3	1360	09/01>	6488.89		
1.4 HDi	DV4TED4	1398	04/02>	6874.83		
1.6 16V	TU5	1587	03/01>	6488.89		
1.6 HDi	DV6TED4	1560	04/04>	6875.83		
2.0 16V	EW10	1997	03/01>	6332.89		
2.0 HDi	DW10	1997	03/01>	5130.83		
	DW10	1997	09/05>	6756.84		
309						
1.1	E1	1118	09/85>07/92	1529.89		
	TU1	1124	08/89>08/93	6148.89		
1.3	G1A / G1B / G2 / G2S	1294	09/85>07/92	1529.89		
	G1A / G2	1294	08/86>07/89	1418.83		
1.4	TU3	1360	08/88>08/94	6148.89		
1.5	Y2 / K	1442	08/86>07/90	1529.89		
	Y2 / K	1442	08/90>07/92	1418.83		
1.6	J2	1592	08/86>07/90	1529.89		
	J2	1592	08/90>07/92	1418.83		
	XU5	1580	08/85>08/93	6148.89		
	XU5	1580	08/89>08/93	5108.89		
1.7 D	XUD7	1769	08/86>05/92	5231.83		
	XUD7	1769	05/92>08/94	5130.83		
1.7 TD	XUD7T	1769	08/89>08/93	4949.89		
	XUD7T	1769	08/89>08/93	5229.83		
1.9	XU9	1905	09/85>08/93	6148.89		
	XU9	1905	08/89>08/93	5108.89		



LISTE D'APPLICATIONS

APPLICATION LIST/ANWENDUNGSLISTE

VEHICULE MODEL FAHRZEUGTYP	MOTEUR ENGINE MOTOR	CYLINDRÉE ENGINE SIZE HUBRAUM	ANNÉE YEAR JAHR	VERNET	PHOTOS PICTURES ZEICHNUNGEN
...309					
1.9 16S	XU9	1905	08/89>08/93	1538.88	
1.9 D	XUD9	1905	08/86>08/93	5231.83	
	XUD9	1905	05/92>08/93	5130.83	
404					
1.5	XB2 / 5	1468	06/62>07/70	1414.75	
1.6	KF2 / XC / 5 / 6 / 7	1618	04/60>05/79	1414.75	
1.8	XMU6S	1796	01/70>10/70	1414.75	
1.8 D	XD85	1816	06/62>06/63	1413.72	
1.9 D	XD88	1948	07/63>06/77	1413.72	
2.0 D	XDP88	1984	09/72>05/79	1413.72	
405					
1.4	TU3	1360	06/87>10/96	6148.89	
1.6	XU5	1580	06/87>06/92	6148.89	
	XU5	1580	06/89>10/96	5108.89	
	XU5	1580	07/92>10/96	5108.83	
1.7 D	XUD7	1769	06/90>05/92	5231.83	
	XUD7	1769	06/92>06/92	5130.83	
1.7 TD	XUD7T	1769	06/87>05/92	5231.83	
	XUD7T	1769	06/88>05/89	1413.72	
	XUD7T	1769	06/92>06/92	5130.83	
	XUD7T	1769	07/93>10/95	6875.83	
1.8	XU7	1761	07/92>10/96	5108.83	
	XU7	1761	07/92>10/96	5108.89	
1.9	XU9	1905	06/87>06/92	1538.88	
	XU9	1905	06/87>06/92	6148.89	
	XU9	1905	06/88>10/96	5108.89	
	XU9	1905	07/92>10/96	5108.83	
1.9 D	XUD9	1905	06/87>05/92	5231.83	
1.9 D / TD	XUD9	1905	06/92>10/96	5130.83	
2.0	XU10	1998	07/92>10/95	4885.89	
	XU10	1998	07/92>10/96	5108.83	
	XU10	1998	07/92>10/96	5108.89	
2.0 Turbo 16	XU10	1998	02/92>10/95	1468.82	
406					
1.6	XU5	1580	10/95>03/99	5108.89	
	XU5	1580	07/96>03/04	5108.83	
1.8	EW7	1749	10/00>04/04	6332.89	
	XU7	1761	10/95>04/04	5108.83	
	XU7	1761	10/95>07/96	5108.89	
1.8 16V	XU7	1761	10/95>04/04	4885.83	
1.9 TD	XUD9T	1905	11/95>03/99	5130.83	
2.0 16V	EW10	1998	04/99>10/04	6332.89	
	XU10	1998	10/95>04/04	4885.83	
2.0 HDi	DW10	1997	10/98>04/04	5130.83	
2.0 Turbo	XU10	1998	07/96>03/99	5108.83	
2.2 16V	EW12	2230	05/00>10/04	6332.89	
2.2 HDi	DW12	2179	10/00>10/04	5130.83	
3.0 V6 24V	ES9J4	2946	10/96>10/04	CT1743.82	
407					
1.6 HDi	DV6TED4	1560	04/04>	6875.83	
1.8 16V	EW7	1749	04/04>	6332.89	
2.0	EW10	1997	04/04>	6332.89	
2.0 HDi	DW10	1997	04/04>	5130.83	
2.2 16V	EW12	2230	04/04>	6332.89	



LISTE D'APPLICATIONS

APPLICATION LIST/ANWENDUNGSLISTE

VEHICULE MODEL FAHRZEUGTYP	MOTEUR ENGINE MOTOR	CYLINDRÉE ENGINE SIZE HUBRAUM	ANNÉE YEAR JAHR	VERNET
...407				
3.0 V6 24V	ES9	2946	04/04>	CT1743.82
504				
1.6	XC7	1618	08/79>07/85	1414.75
	XC7	1618	08/79>07/85	2620.75
1.8	KF5 / 6	1796	06/68>07/70	1414.75
	XM / XM7	1796	06/68>09/93	1414.75
	XM7	1796	08/70>09/93	2620.75
1.9 D	XD88	1948	08/70>07/83	1503.78
	XD88	1948	08/83>07/85	1503.72
2.0	XN1 / XN2 / XNA	1971	09/69>12/00	1414.75
	XN1 / XN2 / XNA	1971	09/69>12/00	2620.75
2.1 D	XD4 / XD90	2112	06/69>07/85	1503.78
	XD4 / XD90	2112	08/83>07/85	1503.72
2.3 D	XD2	2304	08/71>07/83	1503.78
	XD2	2304	08/83>07/96	1503.72
2.5 D	XD3	2498	08/85>09/93	1503.72
2.7 V6	ZMI / ZMJ	2664	09/74>07/84	1183.83
505				
1.6	XC7	1618	08/83>07/84	2620.75
1.8	XM7	1796	05/79>12/90	2620.82
2.0	XN1	1971	05/79>12/90	2620.82
	XN6	1971	08/82>07/88	2620.75
	ZEJ	1995	05/79>12/90	1183.83
2.2	ZDJK / JL	2165	08/81>12/90	1183.83
2.2 / T	N9T / NT9E	2155	08/82>12/90	1418.83
2.3 D	XD2	2304	08/79>07/81	1503.72
	XD2	2304	07/81>07/85	1503.78
2.3 TD	XD2S	2304	08/80>	1503.80
	XD2S	2304	08/80>07/85	4947.81
2.5 D / TD	XD3	2498	08/79>12/90	4947.81
2.8 V6	ZN3J / ZNJK	2849	08/85>12/90	1183.83
604				
2.0	XN6	1971	07/82>12/84	2620.82
2.3 TD	XD2S	2304	02/79>12/85	1503.80
2.5 TD	XD3T	2498	09/83>12/86	4947.81
2.7 V6	ZM / ZMJ	2664	03/76>12/85	1183.83
2.8 V6	ZNJ	2849	09/83>12/86	1183.83
605				
2.0	XU10	1998	10/89>05/99	5108.89
	XU10	1998	01/93>05/99	5108.83
2.0 16V	XU10	1998	07/94>05/99	4885.83
2.1 D	XUD11	2138	09/90>12/90	4640.85
2.5 TD	DK5ATE	2446	07/94>05/99	5313.85
	DK5ATE	2446	07/94>05/99	5413.84





LISTE D'APPLICATIONS

APPLICATION LIST/ANWENDUNGSLISTE

VEHICULE MODEL FAHRZEUGTYP	MOTEUR ENGINE MOTOR	CYLINDRÉE ENGINE SIZE HUBRAUM	ANNÉE YEAR JAHR	VERNET
...605				
3.0 V6	ZPJ / ZPJ4	2975	10/89>05/99	4780.78
3.0 V6 24V	ES9J4	2946	06/97>05/99	CT1743.82
607				
2.0 16V	EW10	1997	05/00>09/04	6332.89
2.0 HDi	DW10	1997	05/00>	5130.83
2.2 16V	EW12	2230	05/00>	6332.89
2.2 HDi 16V	DW12	2179	05/00>	5130.83
3.0 V6 24V	ES9	2946	05/00>	CT1743.82
806				
1.8	XU7	1761	06/95>07/96	5108.89
	XU7	1761	07/96>05/02	5108.83
1.9 TD	XUD9	1905	08/94>05/02	5130.83
2.0	EW10	1997	07/00>05/02	6488.89
	EW10	1997	06/02>	6332.89
	XU10	1998	07/94>07/96	5108.89
	XU10	1998	07/94>05/02	5108.83
2.0 16V	XU10	1998	10/98>05/02	4885.83
2.0 HDi	DW10	1997	08/99>	5130.83
2.1 TD	XUD11	2088	06/96>05/02	5130.83
2.2	EW12	2230	06/02>09/05	6332.89
2.2 HDi	DW12	2179	06/02>	5130.83
3.0	ES9J	2946	06/02>09/05	CT1743.82
807				
2.0 16V	EW10	1997	06/02>	6332.89
2.0 HDi 16V	DW10	1997	06/02>	5130.83
2.2 16V	EW12	2230	06/02>	6332.89
2.2 HDi 16V	DW12	2179	06/02>02/04	5130.83
3.0	ES9	2946	06/02>	CT1743.82
PEUGEOT				
				
Boxer				
1.9 D	XUD9	1905	02/94>12/01	5130.83
1.9 TD	XUD9T / XUD9U	1905	02/94>12/01	4885.83
2.0	XU10	1998	02/94>	5108.83
2.0 HDi	DW10	1997	09/01>	5130.83
2.2 HDi	DW12	2179	01/02>	5130.83
2.5 D	DJ5	2446	02/94>12/01	5309.84
	DJ5	2446	02/94>12/01	5313.85
2.5 TD / TDi	DJ5T	2446	02/94>12/01	5309.84
	DJ5T	2446	02/94>12/01	5313.85
	DJ5T	2446	02/94>12/01	5413.84
2.8 D / TD	8140-63 / 8140-43	2798	06/99>12/01	6581.82
2.8 HDi	8140-43S / F28T	2798	09/00>	6581.82
Expert				
1.6	160A	1581	09/95>12/03	6541.87
1.8	XU7	1761	07/96>12/03	5108.83
1.9 D	DW8	1868	05/98>	5130.83
1.9 D / TD	XUD9	1905	09/95>12/03	5130.83
2.0	EW10	1997	09/00>	6488.89
2.0 HDi	DW10	1997	09/00>	5130.83
J5				
1.8	XM7T	1796	11/81>08/90	2620.75
	XM7T	1796	11/81>02/94	2620.82
1.9 D	XUD9	1905	07/87>02/94	4945.89

PHOTOS PICTURES ZEICHNUNGEN	
	
2620	4780
	
4885	4945
	
5108	5130
	
5309	5313
	
5413	6332
	
6488	6541
	
6581	CT1743



LISTE D'APPLICATIONS

APPLICATION LIST/ANWENDUNGSLISTE

VEHICULE MODEL FAHRZEUGTYP	MOTEUR ENGINE MOTOR	CYLINDRÉE ENGINE SIZE HUBRAUM	ANNÉE YEAR JAHR	VERNET
...J5				
1.9 TD	M705	1929	09/90>02/94	5687.80
2.0	XN1T	1971	11/81>08/90	2620.75
	XN1T	1971	11/81>02/94	2620.82
2.5 D / TD	CRD93	2500	11/81>02/94	0963.86
J7				
1.5	XB5P	1468	06/65>07/70	1414.75
1.6	XC5P / XC7P	1618	09/65>08/79	1414.75
1.8	XM7P	1796	07/70>01/80	1414.75
1.8 D	XDP85	1816	06/65>09/67	1413.72
2.0 D	XDP88	1984	09/65>07/78	1413.72
2.1 D	XDP90	2112	09/67>01/80	1413.72
2.3 D	XD2P94	2304	07/77>01/80	1413.72
J9				
1.6	XC7P	1618	01/80>09/91	1414.75
2.0	XN1P	1971	01/80>09/91	1414.75
2.1 D	XDP90	2112	01/80>07/90	1413.72
2.3 D	XD2P	2304	01/80>07/82	1413.72
2.5 D	XD3P	2498	08/82>09/91	3327.81
P4				
2.3 D	XN8	2298	01/86>	2620.82
2.5 D / TD	XD3	2498	01/86>	4947.81
Partner				
1.1	TU1	1124	06/96>11/02	6148.89
	TU1	1124	01/01>11/02	6191.89
	TU1	1124	11/02>	6488.89
1.4	TU3	1360	06/96>11/02	6148.89
	TU3	1360	05/98>11/98	6106.89
	TU3	1360	11/98>11/02	6191.89
	TU3	1360	11/02>	6488.89
1.6	TU5	1587	09/00>11/02	6191.89
	TU5	1587	11/02>	6488.89
1.6 HDi	DV6	1560	09/05>	6875.83
1.8	XU7	1761	05/97>11/02	5108.83
1.8 D	XUD7	1769	06/96>11/02	5130.83
1.9 D	DW8	1868	10/98>	5130.83
	XUD9	1905	06/96>11/02	5130.83
2.0 HDi	DW10	1997	05/00>	5130.83
Ranch				
1.4	TU3	1360	06/96>05/99	6148.89
	TU3	1360	05/99>	6191.89
1.8	XU7	1761	07/97>11/02	5108.83
1.8 D	XUD7	1769	06/96>11/02	5130.83
1.9 D	DW8	1868	11/98>11/02	5130.83
	XUD9	1905	06/96>	5130.83
2.0 HDi	DW10	1997	01/01>	5130.83
PORSCHE				
924				
2.0		1984	09/77>	1400.83
2.5		2479	09/85>	1439.80





LISTE D'APPLICATIONS

APPLICATION LIST/ANWENDUNGSLISTE















VEHICULE MODEL FAHRZEUGTYP	MOTEUR ENGINE MOTOR	CYLINDRÉE ENGINE SIZE HUBBRAUM	ANNÉE YEAR JAHR	VERNET
928				
4.5		4474	09/77>	1435.80
4.7		4664	09/79>	1435.80
4.9		4957	09/85>	1435.80
5.0		4990	01/89>	1435.80
5.4		5474	01/91>	1435.80
944				
2.5		2479	01/85>	1439.80
3.0		2990	09/88>	1439.80
968				
3.0		2990	09/91>	1439.80
Boxster				
2.5	M96.20	2480	08/96>08/99	6862.83
2.7	M96.22	2687	08/99>10/04	6862.83
3.2	M96.21	3179	08/99>10/04	6862.83
Cayenne NEW				
4.5 / 4.5 S	M48.00 / M48.50	4511	03/03>	6990.83
PROTON				
300				
1.3	4G13	1299	08/96>	5075.88
1.5	4G15	1468	08/96>	5075.88
1.6	4G92	1597	08/96>	6295.82
400				
1.3	4G13	1299	12/95>	5075.88
1.5	4G15P	1468	11/93>	5075.88
1.6	4G92P	1597	11/93>	6295.82
1.8	4G93 / -S	1834	05/96>	6295.82
2.0 D	4D68-0E6	1998	12/95>	6295.82
2.0 TD	4D68-3A0	1998	02/97>	6295.76
RENAULT				
R4				
0.7	680	747	07/61>06/71	4495.83
	680	747	07/61>06/63	4495.86
0.8	800 / B1B	845	07/62>06/86	4495.83
	839	782	07/71>06/82	4495.83
1.0	C1C	956	07/86>10/92	4495.86
1.1	688 / C1E	1108	07/75>10/92	4495.86
	688 / C1E	1108	09/75>10/92	4495.89
	C1E	1108	09/82>10/92	4493.86
R5				
0.8	839	782	01/72>06/81	4493.86
	839	782	01/72>06/81	4495.75
	839	782	01/72>06/81	4495.83
0.9	800	845	07/72>06/85	4493.86
	800	845	07/72>06/84	4495.75
	800	845	07/72>06/85	4495.83
1.0	689	956	01/72>06/85	4493.86
	689	956	01/72>06/85	4495.75
	689	956	01/72>06/85	4495.89
1.1	688	1108	07/79>06/85	4493.86
	688 / C1E	1108	07/79>06/85	4495.75
	688 / C1E	1108	07/79>06/85	4495.89
	C1E	1108	07/79>06/85	4168.89

PHOTOS PICTURES ZEICHUNGEN	
 1435	 1439
 4168	 4493
 4495	 5075
 6295	 6862
 6990	 NEW



LISTE D'APPLICATIONS

APPLICATION LIST/ANWENDUNGSLISTE

VEHICULE MODEL FAHRZEUGTYP	MOTEUR ENGINE MOTOR	CYLINDRÉE ENGINE SIZE HUBRAUM	ANNÉE YEAR JAHR	VERNET	PHOTOS PICTURES ZEICHNUNGEN
R18					
1.4	847	1397	02/79>10/86	4493.89	 1417
	847	1397	02/79>10/86	4495.75	
	847	1397	09/77>10/86	4495.86	
1.6	841 / 843 / A2M / A6M	1647	04/78>10/86	4495.86	 1503
	843 / A2M / A6M	1647	07/79>10/86	4495.75	
1.6 Turbo	A5L	1565	09/80>09/85	4495.86	 1533
	A7L	1565	07/83>10/86	4493.86	
2.0	J6R	1995	09/81>10/86	1533.88	 1547
	J8S	2068	09/80>10/86	4947.81	
2.1 D	852 / J8S	2068	09/80>10/86	4947.81	 1533
	J8S	2068	09/80>10/86	1547.88	
2.1 TD	J8S	2068	03/84>10/86	4947.81	 1547
	J7T	2165	07/83>10/86	1533.88	
Fuego					
1.4	847	1397	09/79>10/85	4493.89	 4168
	847	1397	09/79>10/85	4495.75	
	847	1397	09/79>10/85	4495.86	
1.6	843	1647	07/81>06/83	4168.89	 4493
	A2M / A6M	1647	09/79>10/85	4493.86	
	A2M / A6M	1647	09/79>10/85	4493.89	
	A6M	1647	09/79>10/85	4495.75	
1.6 Turbo	A5L	1565	09/83>10/85	4493.86	 4495
	A7L	1565	07/81>10/85	4168.89	
2.0	829 / J6R	1995	09/80>10/85	1533.88	 4947
2.1 TD	J8S	2068	09/82>10/84	1547.88	
2.2	J7T	2165	07/83>10/85	1533.88	 4947
R19 / Chamade					
1.2	C1G	1237	07/88>10/95	4493.86	 5083
	C1G	1237	07/88>10/95	4493.89	
	C1G	1237	07/88>10/95	4495.83	
	E7F	1171	05/92>10/95	5284.91	
1.4	C1J / C2J / C3J	1397	07/88>10/95	4493.86	 5284
	C1J / C2J / C3J	1397	07/88>10/95	4493.89	
	C1J / C2J / C3J	1397	07/88>10/95	4495.83	
	E6J / E7J	1390	07/88>11/95	5284.91	
1.7	F2N / 724	1721	06/89>11/95	4168.78	 6045
	F2N / F3N	1721	07/88>11/95	6045.89	
1.8	F3N	1721	05/92>11/95	6045.89	
	F3P / F7P	1763	07/88>11/95	6045.89	
1.9 D	F8Q	1870	07/88>11/95	1417.82	
1.9 D / TD	F8Q	1870	07/88>10/95	6045.89	
1.9 TD	F8Q	1870	09/90>10/95	5083.83	
R20					
1.6	843	1647	12/75>12/81	1503.84	
2.0	829	1995	07/77>10/84	1533.88	
2.1	852	2068	10/79>10/84	4947.81	
2.1 TD	J8S	2068	09/82>10/84	4947.81	
2.2	851	2165	07/80>10/84	1533.88	
R21 / Nevada / Savanna					
1.4	C2J	1397	06/88>03/93	4493.86	
	C2J / C2L	1397	06/88>03/93	4493.89	
	C2J / C2L	1397	06/88>10/94	4495.83	
	C2L	1397	06/88>11/92	4495.75	
	C2L	1397	06/90>03/92	4168.89	
1.7	F2N / F3N	1721	03/86>08/95	6045.89	



LISTE D'APPLICATIONS

APPLICATION LIST/ANWENDUNGSLISTE

Thermostats

Renault









VEHICULE MODEL FAHRZEUGTYP	MOTEUR ENGINE MOTOR	CYLINDRÉE ENGINE SIZE HUBRAUM	ANNÉE YEAR JAHR	VERNET
...R21 / Nevada / Savanna				
1.9 D	F8Q	1870	05/89>	1417.82
	F8Q	1870	05/89>10/94	6045.89
2.0	F2R	1965	06/86>03/93	6045.89
2.0 / Turbo	J6R / J6T / J7R	1995	03/86>08/95	4324.89
2.0 Turbo	J7R	1995	06/87>	4493.86
2.1 D / TD	J8S	2068	06/86>08/95	4947.81
2.2	J7T	2165	06/86>08/95	4324.89
2.2 D	J8S	2068	06/86>04/89	4947.81
R25				
2.0	J6R / J7R	1995	09/83>	1533.88
	J6R / J7R	1995	09/83>10/92	4324.89
2.1 D / TD	J8S	2068	09/83>10/92	4947.81
2.2	J7T	2165	09/83>10/92	1533.88
2.5 V6 Turbo	Z7U	2458	09/85>10/92	1183.86
2.6 V6	Z7V	2664	09/83>05/89	1183.86
2.8 V6	Z7W	2849	09/85>10/92	1183.86
R30				
2.1 TD	J8S	2068	10/81>10/84	4947.81
2.7	112 / 140 / 144	2664	03/75>10/84	1533.88
Alliance				
1.4	C3J	1397	06/82>06/87	4493.86
1.7	F3N	1721	08/84>06/87	4168.89
Alpine				
2.5 V6 Turbo	Z7U	2458	09/84>	3335.88
2.7	112	2664	07/76>10/84	1533.88
2.8 V6	Z6W	2849	09/84>07/89	3335.88
Avantime				
2.0 16V Turbo	F4R	1998	11/01>03/03	6047.89
3.0 V6 24V	L7X	2946	09/01>03/03	CT1743.82
Clio / Symbol				
1.0	C1C	956	06/90>	4495.83
	C1C	956	06/90>	4493.86
	D7D	999	04/01>	6126.89
1.1	C1E	1108	06/90>02/96	4495.83
	C1E	1108	06/90>02/96	4493.86
	C1E	1108	06/90>02/96	4493.89
1.2	C3G	1239	07/94>02/96	4493.89
	D4F / D7F	1149	03/98>	6126.89
	D7F	1149	03/96>06/98	5493.89
	E5F / E7F	1171	06/90>02/98	5284.91





LISTE D'APPLICATIONS

APPLICATION LIST/ANWENDUNGSLISTE

VEHICULE MODEL FAHRZEUGTYP	MOTEUR ENGINE MOTOR	CYLINDRÉE ENGINE SIZE HUBRAUM	ANNÉE YEAR JAHR	VERNET	PHOTOS PICTURES ZEICHNUNGEN
...Clio / Symbol					
1.4	E6J / E7J	1390	09/90>02/98	5284.91	 1183
	K4J / K7J	1390	03/98>	6047.89	 1533
	K7J	1390	05/00>03/01	6045.89	
	K7J	1390	12/99>05/00	6320.89	
1.5 DCi	K9K	1461	01/01>	6666.89	
1.6 / 16V	K4M / K7M	1598	03/98>	6047.89	
1.7	F2N	1721	06/90>02/96	6045.89	 1547
1.8	F3P / F7P	1794	09/90>02/98	6045.89	 4324
1.9	F9Q	1870	06/90>	6045.89	
1.9 D	F8Q	1870	06/90>	6045.89	
	F8Q	1870	03/98>03/01	6320.89	
	F8Q	1870	04/01>	6454.89	
	F8Q	1870	07/99>03/01	6923.89	
1.9 DTi	F9Q	1870	04/01>	6045.89	
	F9Q	1870	11/99>03/01	6320.89	
	F9Q	1870	11/99>03/01	6923.89	 4947
	F9Q	1870	04/01>	6454.89	 5284
2.0	F7R	1998	05/93>02/96	6045.89	
2.0 16V	F4R	1998	01/00>	6047.89	
3.0 V6 24V	L7X	2946	01/00>	CT1743.82	
Lutécia					
1.4	E7J	1390	03/96>02/98	5284.91	
1.8	F3P	1794	10/94>02/98	6045.89	
Thalia					
1.4	K4J / K7J	1390	01/01>	6047.89	
1.5 dCi	K9K	1461	01/01>	6666.89	
1.6	K4M	1598	01/01>	6047.89	 6047
Espace					
1.9 DCi	F9Q	1870	09/02>	6454.89	 6454
1.9 DTi	F9Q	1870	07/00>10/02	6045.89	
	F9Q	1870	10/99>06/00	6320.89	 6666
2.0	F3R	1998	09/96>06/00	6045.89	
	J6R / J7R	1995	09/84>01/91	1533.88	
	J7R	1995	01/91>08/96	4324.89	
2.0 16V	F4R	1998	12/98>	6047.89	
2.0 DCi	G9T	2188	07/00>	6964.89	
2.1 TD	J8S	2068	09/84>01/91	1547.88	
	J8S	2068	01/91>08/96	4947.81	 6860
2.2	J7T	2165	09/86>01/91	1533.88	
	J7T	2165	01/91>08/96	4324.89	 6923 NEW
2.2 DT	G8T	2188	09/96>06/00	5446.83	
2.8 V6	Z7W	2849	04/91>08/96	1183.86	
3.0 DCi	P9X	2958	09/02>	6860.82	 6964
3.0 V6	L7X	2946	07/98>10/02	CT1743.82	 CT1743



LISTE D'APPLICATIONS

















APPLICATION LIST/ANWENDUNGSLISTE

VEHICULE MODEL FAHRZEUGTYP	MOTEUR ENGINE MOTOR	CYLINDRÉE ENGINE SIZE HUBRAUM	ANNÉE YEAR JAHR	VERNET	PHOTOS PICTURES ZEICHUNGEN
...Espace					
3.5 V6	V4Y	3498	09/02>	6861.82	 1400
Laguna / Nevada / Estate					
1.6 16V	K4M	1598	05/98>	6047.89	 5353
1.8	F3P	1794	01/94>12/00	6045.89	 5446
1.8 16V	F4P	1783	05/98>	6047.89	 6045
1.9 DCi	F9Q	1870	01/01>	6454.89	 6047
1.9 DCi / DTi	F9Q	1870	05/98>06/01	6045.89	 6126
1.9 DTi	F9Q	1965	05/98>	6320.89	 6320
2.0	F3R	1998	01/94>12/00	6045.89	 6393 NEW
2.0 16V	F4R / F5R	1998	10/99>	6047.89	 6454
	N7Q	1948	05/95>12/00	1400.90	 6628
2.2 D	G8T	2188	03/94>11/95	5353.83	 6666
2.2 D / TD	G8T	2188	07/95>12/00	5446.83	 6703 NEW
2.2 DCi	G9T.7.20	2188	01/01>	6964.89	 6861
3.0 V6	L7X	2946	05/97>	CT1743.82	 6923 NEW
Mégane / Classic / Coupé / Scenic					
1.4 16V	E7J / K4J	1390	11/95>	6047.89	 6964
1.5 DCi	K9K	1461	09/02>	6393.89	 NEW
	K9K	1461	09/02>	6666.89	
	K9K	1461	09/02>	6703.89	
1.6	K7M	1598	11/95>02/99	6045.89	
1.6 / 16V	K4M / K7M	1598	11/95>	6047.89	
1.8 16V	F4P	1783	09/99>	6047.89	
1.9 D / DT / DTi	F8Q / F9Q	1870	11/95>04/03	6045.89	
	F8Q / F9Q	1870	02/98>	6320.89	
1.9 D / DTi	F8Q / F9Q	1870	11/95>08/02	6923.89	
1.9 DCi	F9Q	1870	01/00>12/00	6045.89	
	F9Q	1870	09/99>	6454.89	
	F9Q	1870	09/02>	6628.89	
	F9Q	1870	09/99>08/02	6923.89	
1.9 DTi	F9Q	1870	07/96>03/01	6047.89	
	F9Q	1870	11/00>	6454.89	
2.0	F3R	1998	11/95>02/98	6045.89	
	F3R	1998	02/98>02/99	6320.89	
	F3R / F4R	1998	11/95>	6047.89	
2.0 16V	F4R	1998	12/00>04/03	6454.89	
	F7R	1998	11/95>09/02	6045.89	
2.0 D 16V	F5R	1998	02/99>12/01	6047.89	
Modus NEW					
1.2	D4F	1149	09/04>	6126.89	 CT1743



LISTE D'APPLICATIONS

APPLICATION LIST/ANWENDUNGSLISTE

VEHICULE MODEL FAHRZEUGTYP	MOTEUR ENGINE MOTOR	CYLINDRÉE ENGINE SIZE HUBRAUM	ANNÉE YEAR JAHR	VERNET	PHOTOS PICTURES ZEICHNUNGEN
...Modus					
1.4	K4J.7.70	1390	09/04>	6971.89	 1400
1.5 dCi	K9K	1461	09/04>	6703.89	 4493
	K9K	1461	09/04>	6393.89	
1.6	K4M	1598	09/04>	6971.89	
Safrane					
2.0 16V	N7Q	1948	09/96>11/00	1400.90	 4495
2.2 TD	G8T	2188	09/96>11/00	5446.83	 5446
2.5 20V	N7U	2435	09/96>11/00	1400.90	
2.5 DT	S8U	2445	04/93>09/96	5700.82	 5493
3.0	L7X.7.13	2946	12/98>11/00	CT1743.82	 5700
Spider					
2.0 16V	F7R	1998	01/96>10/99	6045.89	 6045
Twingo					
1.2	C3G	1239	03/93>01/97	4493.89	 6047
	D4F / D7F	1149	06/98>	6126.89	
	D7F	1149	07/96>06/98	5493.89	
Vel Satis					
2.0	F4R	1998	01/02>01/05	6047.89	 6126
2.2 DCi	G9T	2188	01/02>01/05	6964.89	 6393 NEW
3.0 DCi	P9X.7.01	2958	01/02>01/05	6860.82	
3.5	V4Y.7.01	3498	01/02>01/05	6860.82	 6703 NEW
RENAULT 					
Estafette					
1.3	810	1289	09/68>12/80	4495.83	 6860
	810	1289	09/68>12/80	4495.86	
Extra MK					
1.0	C1C	956	09/85>08/91	4493.89	 6964 NEW
1.1	C1E	1108	09/85>08/91	4493.89	
1.2	C1G / C3G	1239	09/91>08/97	4493.89	
					 6971 NEW
					 CT1743



LISTE D'APPLICATIONS

APPLICATION LIST/ANWENDUNGSLISTE

VEHICULE MODEL FAHRZEUGTYP	MOTEUR ENGINE MOTOR	CYLINDRÉE ENGINE SIZE HUBRAUM	ANNÉE YEAR JAHR	VERNET	PHOTOS PICTURES ZEICHNUNGEN
...Extra MK					
1.4	C1J	1397	09/85>08/91	4493.89	 1417
	E6J / E7J	1390	09/91>08/97	5284.91	 1533
1.6 D	F8M	1595	09/85>08/94	6045.89	 4168
1.9 D	F8Q	1870	09/91>08/97	6045.89	 4493
Express					
1.0	C1C	956	09/85>08/91	4493.89	 4168
1.1	C1E	1108	09/85>08/91	4168.89	 4493
	C1E	1108	09/85>08/97	4493.86	
	C1E	1108	09/85>08/94	4493.89	
1.2	C1G	1237	09/91>08/94	4493.86	 4947
	C1G / C3G	1237	09/91>08/97	4493.89	 5284
1.4	C1J	1397	06/87>08/91	4493.86	
	C1J / C2J / C3J	1397	09/85>08/94	4493.89	
	E6J / E7J	1390	09/91>08/97	5284.91	
1.6 D	F8M	1595	09/95>	1417.82	 5493
	F8M	1595	09/85>08/94	6045.89	 6045
1.9 D	F8Q	1870	09/92>	1417.82	
	F8Q	1870	09/91>08/97	6045.89	
Kangoo					
1.2	D4F / D7F	1149	09/98>	6126.89	 6047
	D7F	1149	09/97>	5493.89	 6126
1.4	E7J / K7J	1390	09/97>	6047.89	
1.5 DCi	K9K	1461	03/03>	6666.89	 6320
1.6	K4M / K7M	1598	12/99>	6047.89	 6454
1.9 D	F8Q	1870	09/97>02/03	6045.89	
	F8Q	1870	03/03>	6454.89	
1.9 DCi / DTi	F9Q	1870	01/02>	6454.89	
1.9 DTi	F9Q	1870	12/99>02/03	6320.89	 6666
	F9Q	1870	01/98>02/03	6923.89	 6923 NEW
Master					
1.9 DCi	F9Q	1870	02/01>	6454.89	
1.9 DTi	F9Q	1870	02/01>	6045.83	
2.0	J5R	1995	08/80>09/94	1533.88	
2.1 D	J8S	2068	08/80>09/94	4947.81	
2.2	J7T	2165	10/94>09/97	1533.88	



LISTE D'APPLICATIONS

APPLICATION LIST/ANWENDUNGSLISTE

VEHICULE MODEL FAHRZEUGTYP	MOTEUR ENGINE MOTOR	CYLINDRÉE ENGINE SIZE HUBRAUM	ANNÉE YEAR JAHR	VERNET	PHOTOS PICTURES ZEICHUNGEN
...Master					
2.2 DCi	G9T.7.50	2188	10/03>	6970.83	 1533
2.4 D	S8U	2445	08/80>02/89	5898.79	 1547
2.5 D	S8U	2445	03/89>09/03	5898.79	
2.5 D / TD	S8U / S9U	2499	03/89>09/97	5898.76	
2.5 DCi	G9U.7.20 / G9U.7.30	2463	10/03>	6970.83	
2.8 DTi	S9W	2800	01/98>09/03	5898.79	
Rapid					
1.0	C1C	956	09/85>08/91	4493.86	 4493
	C1C	956	09/85>08/91	4495.83	 4495
1.1	C1E	1108	09/85>08/91	4493.86	 4947
	C1E	1108	09/85>08/91	4495.83	 5898
1.4	C1J	1397	09/85>08/91	4493.86	
	C1J	1397	09/85>08/91	4495.83	
	C3J	1397	01/88>08/91	4493.89	
1.6 D	F8M	1595	09/85>08/91	6045.89	 6045
1.9 D	F8Q	1870	09/91>03/98	6045.89	 6047
Rodeo					
0.8	800	845	09/70>10/81	4495.83	
Trafic					
1.4	847	1397	07/80>02/89	4493.89	 6454
	847	1397	07/80>02/89	4495.86	 6970
	847 / C1J	1397	07/80>06/91	4495.75	NEW
1.6	841 / A1M	1647	07/80>02/89	4493.86	
	841 / A1M	1647	07/80>02/89	4495.75	
1.7	FIN	1721	07/80>09/94	6045.89	
1.9 D	F8Q	1870	09/97>03/01	6045.89	
1.9 DCi	F9Q	1870	04/01>	6454.83	
	F9Q	1870	04/01>	6454.89	
2.0	F4R	1998	04/01>	6047.89	
	J5R	1995	07/80>09/94	1533.88	
2.1 D	852 / J8S	2068	07/80>09/94	1547.88	
	852 / J8S	2068	07/80>08/97	4947.81	
2.2	J7T	2165	03/89>08/97	1533.88	
2.4 D	S8U	2445	10/94>08/97	5898.76	
	S8U	2445	07/83>02/89	5898.79	
2.5 D	S8U	2445	09/97>03/01	5898.76	
	S8U	2445	07/83>08/97	5898.79	



LISTE D'APPLICATIONS

APPLICATION LIST/ANWENDUNGSLISTE

VEHICULE MODEL FAHRZEUGTYP	MOTEUR ENGINE MOTOR	CYLINDRÉE ENGINE SIZE HUBRAUM	ANNÉE YEAR JAHR	VERNET
ROVER				
Ambassador				
All models			01/82>12/84	1419.82
			12/84>	1290.82
Austin Allegro				
1.1	11H	1098	05/73>12/82	1378.83
1.3	12H	1275	05/73>12/82	1378.83
1.5	15H	1485	05/73>12/82	1419.82
1.7	17H	1749	05/73>12/82	1419.82
Coupe / Cabriolet				
1.6	16K4F	1589	03/96>	5955.88
1.8	18K4K	1796	03/96>	5955.88
MG F / TF / ZR / ZS / ZT				
1.4	14K4F	1396	06/01>	5955.88
1.6	16K4F	1589	02/00>	5955.88
1.8 16V	18K4F / K	1796	03/95>	5955.88
2.0 CDTi	M47R2	1951	12/02>	6952.88
2.0 TD	20L2N	1994/1996	05/02>	6880.00
Maestro				
1.3	12H959	1275	03/83>01/86	5504.88
	12HA / HC	1275	03/83>06/90	5504.88
1.6	16H / HA / HB / HC	1598	03/83>04/92	5504.88
	16H956	1598	03/83>10/84	5504.88
	ROVE10	1598	03/83>10/88	5504.88
2.0	20HA / HB / HC	1994	03/83>11/91	5504.88
2.0 D Van	BA	1994	10/87>01/95	1419.82
Marina				
1.3	12H	1275	01/71>12/80	1290.82
1.7	17H	1749	01/78>12/80	1419.82
1.8	ICV2L	1769	01/71>12/80	1290.82
Metro				
1.0	99H	998	10/80>09/90	5504.88
1.1	11K2A / B / D	1129	05/90>01/95	5955.88
1.3	12H / HC / HD	1275	02/81>09/90	5504.88
1.4	14K2A / B / D	1396	05/90>01/95	5955.88
1.4 D	10FTO	1360	05/92>01/95	1542.89
Mini				
0.9 - 850	85H	848	10/80>09/82	5504.88
1.0 - 1000	99H	998	04/70>08/90	5504.88
1.1 - 1100	10H	1098	10/80>09/82	5504.88
1.3 - 1300	12A2A / B / D / E	1275	09/90>10/99	5504.88
Montego				
1.3	12HA37	1275	05/84>10/92	5504.88
1.6	16HA35	1598	05/84>12/94	5504.88
2.0	20HA / B / D	1994	05/84>12/94	5504.88
2.0 TD	BB	1994	10/88>12/94	1378.83
Princess				
1.7	17H	1749	01/75>12/81	1419.82
1.8	ICV2L	1769	01/75>12/81	1378.83
2.0	20HA	1994	01/75>12/81	1419.82
2.2	22H	2194	01/75>12/81	1378.83
SD1				
2.0 - 2000	20V973	1994	01/82>10/86	5504.88
2.3 - 2300	PE146	2350	10/80>12/81	5504.88
2.6 - 2600	PE166	2597	09/82>01/87	5504.88
3.5 - 3500	PE186	3497	01/76>10/86	1290.88



1290



1378



1419



1542



5504



5955



6880







6952

NEW



LISTE D'APPLICATIONS

APPLICATION LIST/ANWENDUNGSLISTE

VEHICULE MODEL FAHRZEUGTYP	MOTEUR ENGINE MOTOR	CYLINDRÉE ENGINE SIZE HUBRAUM	ANNÉE YEAR JAHR	VERNET	PHOTOS PICTURES ZEICHNUNGEN
Série 100					
1.1 - 111	11K2A / B	1129	09/90>	5962.82	
	11K2A / B / D	1129	09/90>	5955.88	
	11K2A / B / D	1129	09/90>	5962.88	
1.4 - 114	14K2A	1396	09/90>	5962.82	
	14K2A / D	1396	09/90>12/92	5955.88	
	14K2A / D	1396	09/90>	5962.88	
1.4 - 114 16V	14K4C / D / F	1396	09/90>	5962.88	
	14K4C / D / F	1396	09/90>12/92	5955.88	
1.4 D - 114	10FTO	1360	05/92>	1542.89	
1.5 D - 115	VJZ	1527	01/95>	1542.89	
Série 200					
1.1 - 211	11K2F	1113	01/98>11/99	5955.88	
1.3 - 213	EV	1342	06/84>09/90	5952.82	
1.4 - 214	14K2A	1396	10/89>	5962.82	
	14K2A / D	1396	10/89>03/96	5962.88	
	14K2F	1396	11/95>	5955.88	
1.4 - 214 16V	14K4C / D	1396	10/89>	5962.82	
	14K4C / D / F	1396	10/89>03/96	5962.88	
	14K4F	1396	11/95>	5955.88	
1.6 - 216	H16A / B	1598	03/85>03/90	5504.88	
1.6 - 216 16V	16K4F	1589	11/95>	5955.88	
	D16A7 / 8 / 9	1590	10/89>03/96	6599.78	
	D16Z2	1590	10/89>03/96	6599.78	
1.8 - 218	ICV2L	1769	03/85>	5231.83	
	IOCU4N	1905	03/96>	5231.83	
1.8 - 218 16V	18K4K	1796	03/96>	5955.88	
2.0 - 220	20M4F	1994	11/91>03/96	5504.88	
2.0 TD - 220	20T2N / R	1994	11/95>	5504.88	
Série 400					
1.4 - 414 16V	14K4C / D	1396	03/90>03/91	5962.82	
	14K4C / D	1396	03/91>09/91	5962.88	
	14K4C / D / F	1396	04/91>03/00	5955.88	
1.6 - 416 16V	16K4F	1589	05/95>03/00	5955.88	
	D16A7 / 8 / 9	1590	03/90>04/95	6599.78	
	D16Y3E	1590	05/95>03/00	6267.78	
	D16Z2	1590	04/90>04/95	6599.78	
1.7 TD - 417	ICV2L	1769	04/91>04/95	5231.83	
	IOCV2L	1769	11/93>04/95	5231.83	
1.9D - 419	IOCU4N	1905	11/93>04/95	5231.83	
2.0	20T4H	1994	11/95>03/00	5504.88	
2.0 - 420	20T4H	1994	10/92>04/95	5504.88	
2.0 - 420 16V	20M4F	1994	11/91>09/92	5504.88	
	20T4H	1994	10/92>04/95	1427.88	
2.0 - 420 Turbo 16V	20T4G	1994	10/92>04/95	1427.88	
	20T4G	1994	10/92>04/95	5504.88	
2.0 TD - 420	20T2N / R	1994	11/95>03/00	5504.88	
Série 600					
1.8 - 618 16V	F18A3	1850	03/96>06/00	6599.78	
2.0 - 620	F20Z1 / 2	1997	04/93>06/00	6599.78	
2.0 - 620 Turbo	20T4G	1994	07/94>06/00	1427.88	
	20T4G	1994	07/94>	5504.88	
2.0 Di / SDi	20T2N	1994	12/94>06/00	6880.00	
2.3 - 623 16V	H23A3	2259	10/93>06/00	6599.78	
					



LISTE D'APPLICATIONS

APPLICATION LIST/ANWENDUNGSLISTE

















VEHICULE MODEL FAHRZEUGTYP	MOTEUR ENGINE MOTOR	CYLINDRÉE ENGINE SIZE HUBRAUM	ANNÉE YEAR JAHR	VERNET
Série 800				
2.0 - 820	20HD01 / 2	1994	05/88>09/90	5504.88
	20M4G	1994	04/91>09/91	5504.88
	M16I	1994	09/86>09/91	5504.88
2.0 - 820 16V	20T4H	1994	10/91>09/98	5504.88
	M16E	1994	05/88>09/90	5504.88
2.0 - 820 Turbo 16V	20T4GG	1994	10/91>12/95	5504.88
2.5 TD - 825	97A	2498	07/89>09/98	5963.80
2.7 - 827 V6 24V	C27A1	2675	09/87>12/95	5952.78
25				
1.1	11K4F4	1119	03/01>	5955.88
1.4 16V	14K4F4	1396	12/99>	5955.88
1.6 16V	16K4F4	1588	12/99>	5955.88
1.8 16V	18K4 / 18K16	1796	12/99>	5955.88
2.0 D / Di	20K-101 / 20L2N	1996	12/99>	6880.00
45				
1.4 16V	14K4F4	1396	01/00>	5955.88
1.6 16V	16K4F4	1589	01/00>	5955.88
1.8 16V	18K4F	1796	01/00>	5955.88
2.0 D / Di / DTi	20K6	1997	01/00>	6880.00
2.0 V6 24V	20K4F	1991	01/00>	1427.88
	20K4F	1991	01/00>	5504.88
75				
1.8 16V	18K4F	1796	02/99>	5955.88
2.0 CDT / CDTi	M47R2	1951	02/99>	6952.88
Streetwise NEW				
1.4	14K4F4	1396	08/03>	5955.88
2.0 D	20L2N	1996	09/03>	6880.00
SAAB				
9-5				
2.0 Turbo 16V	B205E / R	1985	09/97>08/01	5981.89
2.2 TiD	D223L	2171	01/03>08/01	6857.92
2.3 Turbo 16V	B235E / L / R	2290	09/97>08/01	5981.89
3.0 TiD	D308L	2962	09/01>	6583.82
3.0 V6 Turbo	B308E	2962	01/98>08/03	6249.92
90 / 9-3 / 9-6				
1.5 V4	SAAB03	1498	01/66>	1514.88
1.8	B207E	1998	09/02>	5981.89
1.9 TiD	Z19DT / H	1910	06/04>	6857.92
2.0 16V	B204I	1985	04/98>05/03	5981.89
2.0 Turbo	B207L / R	1998	09/02>	5981.89
	SAAB02	1985	11/67>	1514.88
2.0 Turbo 16V	B204L	1985	04/98>05/03	5981.89
2.2 iD	X22DTL	2172	05/98>08/02	5981.89
2.2 TiD	D223L	2171	01/03>	6857.92
2.3 16V	B234I / B234R	2290	04/98>05/03	5981.89
900				
2.0	B204I / L / B206I	1985	07/93>02/98	5981.89
2.0 Turbo	B20T	1985	08/76>09/93	3334.92
2.3	B234I	2290	07/93>02/98	5981.89
2.5	B258I	2498	07/93>	6249.92

PHOTOS PICTURES ZEICHUNGEN	
 1427	 1514
 3334	 5504
 5952	 5955
 5963	 5981
 6249	 6583
 6857	 6880
 6952	NEW



LISTE D'APPLICATIONS

APPLICATION LIST/ANWENDUNGSLISTE

VEHICULE MODEL FAHRZEUGTYP	MOTEUR ENGINE MOTOR	CYLINDRÉE ENGINE SIZE HUBRAUM	ANNÉE YEAR JAHR	VERNET	PHOTOS PICTURES ZEICHNUNGEN
9000					
2.0 16V	B2021 / L	1985	06/84>07/94	5981.89	 245F
	B2021 / L	1985	06/84>07/94	6063.82	 1290
	B204I	1985	07/93>07/98	5981.89	
	B204I	1985	07/93>07/98	6063.82	
2.3 16V	B234E / I / L / R	2290	01/90>07/98	5981.89	 1439
	B234E / I / L / R	2290	01/90>07/98	6063.82	 1473
3.0 V6	B308I	2962	07/94>	6249.92	
99					
1.7 V4		1700	11/67>	3339.88	 1514
1.8		1850	11/67>	3339.88	 1522
1.9	SAAB01	1854	11/67>07/74	1290.88	
2.0	B20C / I / S / T / B201C	1985	08/76>07/85	1514.88	 3311
	B20C / I / T	1985	08/74>08/76	1290.88	 3339
	SAAB02	1985	12/67>07/74	1290.88	
SEAT					
124 / 127 / 128 / 131					
All models			01/70>	3311.80	 5973
			01/70>	245F.79	 5981
			01/70>	1522.87	
			01/70>	1473.88	
Alhambra					
1.8 20V	AJH / AWC	1781	05/98>05/00	6276.87	 6063
1.9 TDi	1Z	1896	03/96>06/96	1439.87	 6249
	AFN / AHU	1896	07/96>	6273.87	
	ANU / AUY / ASZ	1896	06/00>	6273.87	
2.0	ADY	1984	03/96>05/00	1439.87	 6273
	ATM	1984	06/00>05/00	6276.87	 6276
2.8 24V	AUE / AYL	2792	06/00>06/02	5973.80	
	AUE / AYL	2792	06/02>	6533.80	
Altea					
1.6	BGU	1595	03/04>	6276.87	 6533
1.9 TDi	BJB / BKC	1896	40/04>	6273.87	 6864
2.0 FSi	BLR / BLY	1984	05/04>	6864.105	



LISTE D'APPLICATIONS

APPLICATION LIST/ANWENDUNGSLISTE













VEHICULE MODEL FAHRZEUGTYP	MOTEUR ENGINE MOTOR	CYLINDRÉE ENGINE SIZE HUBRAUM	ANNÉE YEAR JAHR	VERNET
...Altea				
2.0 TDi	BKD	1968	03/04>	5962.88
Arosa				
1.0	AER / AHT / ALD	999	02/97>07/00	6274.87
	ALL / ANV / AUC	999	08/97>06/04	6274.87
1.4	AEX / AKK / AKV	1390	02/97>10/00	6274.87
	ANW / APQ / AUB / AUD	1390	12/97>06/04	6274.87
1.4 16V	AFK / ANM / AQQ	1390	01/99>09/00	6274.87
1.4 TDi	AMF	1422	10/99>06/04	6273.87
1.7 SDi	AKU	1716	08/97>10/03	6273.87
Cordoba				
1.0	AER / ALD	999	06/97>08/02	6274.87
	ANV / AUC	999	08/99>08/02	6274.87
1.0 16V	AST / AVZ	999	05/00>08/02	6274.87
1.2	AZQ	1198	10/02>04/04	6965.00
1.4	ABD	1391	11/93>11/95	5151.84
	AEX	1390	09/95>12/97	6274.87
	AKK / AKV / ANW	1390	06/97>08/02	6274.87
	ANX / APQ / AUB / AUD	1390	12/97>08/02	6274.87
	BBY / BBZ	1390	09/02>	6274.87
1.4 16V	AFH / APE / AQQ	1390	06/97>08/02	6274.87
1.4 TDi	AMF	1422	10/02>	6273.87
1.6	1 F	1595	11/93>05/99	1439.87
	ABU	1598	09/93>08/94	5151.84
	AEE / ALM	1598	09/97>08/02	6274.87
	AEH / AKL	1595	05/99>08/02	6276.87
	AFT	1598	09/95>05/99	1439.87
	APF / AUR	1595	09/99>08/02	6276.87
1.8	ABS / ADL	1781	11/93>06/96	1439.87
	ACC / ADZ	1781	07/94>05/99	1439.87
1.8 20V Turbo	AQX	1781	12/99>08/02	6276.87
1.9 D	1Y	1896	11/93>04/99	3349.87
1.9 SDi	AEY	1896	07/96>05/99	3349.87
	AEY / AGP / AQM	1896	05/99>08/02	6273.87
	ASY	1896	09/02>	6273.87
1.9 TD	AAZ	1896	11/93>06/96	3349.87
1.9 TDi	1Z / AFN / AHU	1896	07/96>05/99	3349.87
	AFN	1896	12/96>08/02	6273.87
	AGR / ALH / ASV	1896	05/99>08/02	6273.87
	ASZ / ATD	1896	09/02>	6273.87
2.0	2E / AGG	1984	11/93>04/99	1439.87
	AZL	1984	09/02>	6276.87
2.0 16V	ABF	1984	07/96>04/99	6434.82
Ibiza				
0.9	100 / 146	903	09/82>	1522.87
	100 / 146	903	08/84>01/93	6070.87
1.0	AAU	1043	02/93>06/96	5151.84
	AER / ALD	999	09/96>11/01	6274.87
	ANV / AUC	999	08/99>11/01	6274.87
1.0 16V	AST / AVZ	999	05/00>11/01	6274.87
1.2	021A-1000	1193	08/84>02/93	1439.87
	AZQ / BME	1198	11/01>	6965.00
1.3	2G / AAV	1272	02/93>07/94	5151.84





LISTE D'APPLICATIONS

APPLICATION LIST/ANWENDUNGSLISTE

VEHICULE MODEL FAHRZEUGTYP	MOTEUR ENGINE MOTOR	CYLINDRÉE ENGINE SIZE HUBRAUM	ANNÉE YEAR JAHR	VERNET	PHOTOS PICTURES ZEICHNUNGEN
... Ibiza					
1.4	ABD	1391	09/93>06/96	5151.84	
	AEX / AKK / AKV	1390	07/95>01/01	6274.87	
	ANW / ANX / APQ / AUD	1390	12/97>11/01	6274.87	
	BBY / BBZ	1390	01/02>	6274.87	
	BKY	1400	05/04>	6274.87	
1.4 16V	AFH / APE	1390	06/97>11/01	6274.87	
	AQQ / AUB	1390	02/00>	6274.87	
1.4 TDi	AMF	1422	05/02>	6273.87	
1.5	021A-2000	1461	08/84>01/91	1439.87	
1.6	1F	1595	05/94>06/99	1439.87	
	ABU	1598	02/93>07/94	5151.84	
	AEE / ALM	1598	09/97>11/01	6274.87	
	AEH / AKL	1595	06/99>11/01	6276.87	
	AFT	1598	12/95>06/99	1439.87	
	APF / AUR	1595	03/00>11/01	6276.87	
1.7 D	022A-5000	1714	08/84>02/93	5074.80	
1.8	ABS / ACC	1781	02/93>06/99	1439.87	
	ADL / ADZ	1781	02/94>06/99	1439.87	
1.8 20V Turbo	AQX	1781	12/99>11/01	6276.87	
1.9 D	1Y	1896	02/93>06/96	6273.87	
	1Y	1896	07/96>06/99	3349.87	
1.9 SDi	AEY	1896	12/95>06/96	6273.87	
	AEY	1896	07/96>06/99	3349.87	
	AGP / AQM / ASY	1896	05/99>	6273.87	
1.9 TD	AAZ	1896	02/93>06/96	6273.87	
	AAZ	1896	07/96>06/99	3349.87	
1.9 TDi	1Z / AFN / AHU	1896	07/96>06/99	3349.87	
	AGR / ALH / ASV / ASZ / ATD	1896	03/99>	6273.87	
2.0	2E / AGG	1984	02/93>06/99	1439.87	
	AZL	1984	07/02>	6276.87	
2.0 16V	ABF	1984	07/96>06/99	6434.82	
Leon					
1.4 16V	AHW / APE / AXP / BCA	1390	11/99>	6274.87	
1.6	AEH / AKL	1595	08/99>	6276.87	
1.6 16V	AUS / AZD / BCB	1595	06/00>	6274.87	
1.8	BAM	1781	01/03>	6276.87	
1.8 20V	AGN / AMK / APG	1781	11/99>	6276.87	
	AJQ / APP / ARY / AUQ	1781	08/99>	6276.87	
1.9 SDi	AQM	1896	06/00>	6273.87	
1.9 TDi	AGR / AHF	1896	11/99>	6273.87	
	ALH / ARL / ASV	1896	11/99>	6273.87	
	BLS	1896	11/05>	6273.87	
2.0 TDi	BMM	1968	10/05>	6273.87	
2.0 TFSi	BWA	1984	11/05>	6977.00	
Malaga					
1.2	021A-1000	1193	05/85>	1439.87	
1.5	021A-2000	1461	05/85>	1439.87	
1.7 D	022A-5000	1714	05/85>	5074.80	
Marbella / Panda					
0.9 - 34	08NCA	850	02/80>	1473.88	
0.9 - 45	08NCA	850	03/87>	1522.87	
0.9 - 900	100GL	903	09/86>	6070.87	
					
					
					NEW



LISTE D'APPLICATIONS

APPLICATION LIST/ANWENDUNGSLISTE

VEHICULE MODEL FAHRZEUGTYP	MOTEUR ENGINE MOTOR	CYLINDRÉE ENGINE SIZE HUBRAUM	ANNÉE YEAR JAHR	VERNET
Ronda				
1.2	021A-1000	1193	10/84>06/87	1439.87
	SEAT4	1193	10/84>06/86	1439.87
1.5	021A-2000 / C-2000	1461	10/84>06/87	1439.87
1.6	SEAT9	1592	06/82>07/84	1439.87
1.6 Crono	SEAT9	1592	08/84>06/85	245F.79
1.7 D	SEAT10	1714	10/84>06/85	1439.87
	SEAT10	1714	07/85>12/86	5074.80
Toledo				
1.4 16V	AHW / AXP	1390	01/00>	6274.87
1.6	1F / ABN	1595	02/91>10/98	1439.87
	AEH / AKL	1595	10/98>	6276.87
	EZ / AFT / AKS	1595	09/96>10/98	1439.87
1.6 16V	AUS	1595	06/00>04/01	6274.87
1.8	ABS / ADZ	1781	11/93>10/98	1439.87
1.8 16V	KR / PL / RP	1781	02/91>11/93	1439.87
1.8 20V	AGN / APG	1781	10/98>	6276.87
1.9 D / TD	1Y / AAZ	1896	02/91>10/98	3349.87
1.9 TDi	1Z	1896	10/95>12/96	3349.87
	AFN / AHU	1896	12/96>10/98	3349.87
	AGR / AHF / ALH / ASV	1896	10/98>	6273.87
2.0	2E / AGG	1984	02/91>10/98	1439.87
2.0 16V	ABF	1984	03/94>04/97	6434.82
2.0 FSi	BLR / BLY	1984	09/04>	6864.105
2.0 TDi	AZV / BKD	1968	09/04>	5962.88
2.3	AGZ	2324	10/98>	5973.80
SEAT 				
Inca				
1.4	AEX / AKV / APQ / AUA / AUD	1390	11/95>	6274.87
1.6	1 F	1595	11/95>05/97	1439.87
	AEE	1598	06/97>	6274.87
1.7 SDi	AHB	1714	07/96>	6273.87
1.9 D / SDi	1Y / AEY / AYQ	1896	11/95>	6273.87
Fura				
0.9	100GL	903	09/82>	1522.87
	100GL	903	09/82>	6070.87
Terra				
0.9	100GL	903	09/86>	1522.87
1.3 D	MN	1272	01/90>	1439.87
1.4 D	1W	1391	01/91>	1439.87
SKODA				
100 / 130				
1.0 - 100		988	01/70>	4608.80
1.0 - 105		1046	10/76>	4608.80
1.1 - 110		1107	01/70>	4608.80
1.2 - 120		1174	09/79>	4608.80
1.3 - 130		1289	09/85>	4608.80
Fabia				
1.0	ARV / ATY / AQV	997	02/00>	6732.88
1.2	BMD / BME	1198	05/04>	6732.88
1.4	AME	1397	10/99>05/03	6733.88
	AQW / ATZ / AZF / AZE	1397	12/99>05/03	6732.88
	BBZ / BKY	1390	09/00>	6274.87





LISTE D'APPLICATIONS

APPLICATION LIST/ANWENDUNGSLISTE

VEHICULE MODEL FAHRZEUGTYP	MOTEUR ENGINE MOTOR	CYLINDRÉE ENGINE SIZE HUBRAUM	ANNÉE YEAR JAHR	VERNET
...Fabia				
1.4 16V	AUA / AUB / BBY	1390	10/99>	6274.87
	AUA / AUB / BBY / BBZ / BKY	1390	10/99>	5962.82
1.4 TDi	AMF	1422	03/03>	6274.87
	AMF	1422	03/03>	5962.82
	AMF	1422	05/03>	6273.87
	AMF	1422	04/03>	6733.88
1.9 SDi	ASY	1896	10/99>	6273.87
1.9 TDi	ASZ / ATD	1896	02/00>	6273.87
2.0	AZL	1984	07/00>	6276.87
Favorit				
1.3	SKOD10	1289	09/88>	4608.88
Felicia				
1.3	135 / CP	1289	10/95>06/96	6859.88
	135 / CP / I / 136I / AMG	1289	10/94>07/95	4608.80
	135 / CP / I / 136I / AMG	1289	10/94>01/96	4608.88
	135CP / I / 136I / 13MP / AMG	1289	10/94>12/97	6733.88
1.6	16MPI / AEE	1598	05/95>08/01	6274.87
1.9 D	AEF	1896	10/95>08/01	3349.87
Octavia				
1.4	AMD / AXP / BCA	1390	02/99>	6274.87
1.6	AEE	1598	05/98>09/04	6274.87
	AEH / AKL / AVU / BFQ / BGU	1595	04/97>	6276.87
1.6 FSI	BLF	1598	05/04>	6965.00
1.8 20V	AGN / AGU / ARX / ARZ / AUM / AUQ	1781	10/96>	6276.87
1.9 D	AQM / ASZ	1896	08/00>09/04	6273.87
1.9 SDi	AGP	1896	05/97>07/00	6273.87
1.9 TDi	AGR / AHF	1896	10/96>	6273.87
	ALH / ASV / ATD / BJB	1896	01/00>	6273.87
2.0	AEG / APK / AQY / AZH	1984	05/99>	6276.87
	AZJ / ATF	1984	05/99>	6276.87
2.0 TDi	AZV / BKD	1968	05/04>	5962.88
Superb				
1.8	AWT	1781	12/01>	6276.87
1.9 TDi	AVB / AVF / AWX / BSV	1896	12/01>	6273.87
2.0	AZM	1984	12/01>	6276.87
2.5 TDi	AYM / BDG	2496	12/01>	5902.87
2.8	AMX / BBG	2771	12/01>	6533.92
SMART				
Fortwo NEW				
0.8 CDi	660.940	799	09/99>	6969.00
SSANGYONG				
Family				
2.6	4ZEI	2559	03/90>	5971.82
Musso				
2.9 D	OM602D29	2874	08/93>03/99	5699.85

PHOTOS PICTURES ZEICHNUNGEN	
	
3349	4608
	
5699	5902
	
5962	5971
	
6273	6274
	
6276	6533
	
6733	6859
	
6965	6969
	NEW
	NEW



VEHICULE MODEL FAHRZEUGTYP	MOTEUR ENGINE MOTOR	CYLINDRÉE ENGINE SIZE HUBRAUM	ANNÉE YEAR JAHR	VERNET
----------------------------------	---------------------------	-------------------------------------	-----------------------	--------

PHOTOS PICTURES ZEICHUNGEN

SUBARU

Domingo				
1.0	EF	989	11/88>	1248.80
1.2	EF	1189	10/83>	1248.80
E12				
1.2	EF12EF / N / R / X	1189	10/94>	3328.85
	EF12EN / R	1189	05/93>09/94	1248.80
Forester				
2.0	EJ202 / 205 / 20J	1994	07/97>	6736.78
Impreza				
1.6	EJ16 / EJ16E / EJ161	1597	01/93>	6736.78
1.8	EJ18E / EJ181	1820	01/93>07/97	6736.78
2.0 / 2.0 STi	EJ20	1994	12/93>	6736.78
Justy				
1.0	EF	989	02/84>	1248.80
	EF10NF1	997	06/86>05/95	3328.85
1.2	EF	1189	02/84>	1248.80
	EF12AT / EF12AW	1189	08/88>06/94	3328.85
1.3 4WD	EF	1298	11/88>	1248.80
All models	G13BA	1298	10/95>10/03	3328.88
Legacy				
1.6	EJ16AR	1597	05/89>09/94	6736.78
1.8	EJ18AR / EN / JN / SN	1820	05/89>11/98	6736.78
2.0	EJ20EN	1820	02/89>11/98	5971.82
	EJ20EN / ER / GN	1994	08/91>01/98	6736.78
2.0 Turbo	EJ20JN	1820	01/89>09/94	5971.82
2.2 4WD	EJ22EN / ER	2212	08/89>06/97	6736.78
2.5 4WD	EJ25D	2457	07/96>11/98	6736.78
Leone				
1.3	EA65-	1298	07/84>08/89	5971.82
1.6	EA71-	1298	07/84>08/89	5971.82
1.8	EA81- / EA82-	1798	10/79>08/89	5971.82
Vanille				
0.6	EF12ER	1189	10/94>	3328.85
1.2 4WD	EF12ER	1189	06/94>09/94	1248.80
Vivio				
0.6	EN07A2M / EC / FM	658	03/92>	1248.80
	EN07ERW	658	03/92>	1248.80
0.6 4WD	EN07ERC / M	658	03/92>	1248.80
XT				
1800	EA82T	1781	09/85>12/90	5971.82

SUZUKI

Alto				
0.6	F6	660	01/90>	3328.82
0.8	F8 / F8A / F8B	796	10/80>02/94	3328.82
1.0	G10B	993	03/94>05/02	3328.82
1.1	F10B	1061	06/02>	3328.82
Baleno				
1.3 16V	G13BB	1298	04/95>	3328.88
1.5 16V	G15A	1493	04/95>	3328.88
1.6 16V	G16B	1590	04/95>	3328.88
1.8 16V	J18A	1840	06/96>	6737.82
1.9 TD	XUD9T	1905	12/99>	5130.83
Cappuccino				
0.7	F6A-T	657	01/91>03/98	3328.82

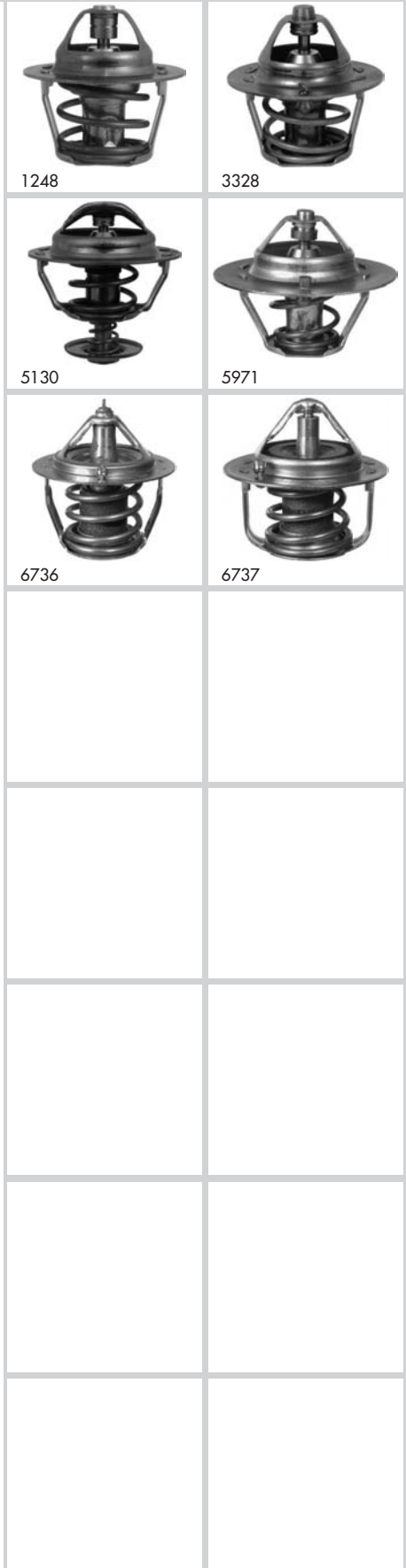



LISTE D'APPLICATIONS

APPLICATION LIST/ANWENDUNGSLISTE

VEHICULE MODEL FAHRZEUGTYP	MOTEUR ENGINE MOTOR	CYLINDRÉE ENGINE SIZE HUBRAUM	ANNÉE YEAR JAHR	VERNET
Carry				
0.5 4WD	F5A	543	09/76>12/78	5075.82
0.6	F6A	657	10/90>	5075.82
0.6 4WD / Turbo	F6A / A-T	657	10/90>	5075.82
0.8	F8A	796	10/78>10/85	5075.82
1.0	F10A	970	09/76>	3328.82
1.3	G13BB-E6	970	07/99>	3328.82
Super Carry				
0.6	F6A-T	657	10/90>	5075.82
0.8	F8A	796	04/85>01/99	5075.82
1.0	F10A / AC	970	04/85>01/99	5075.82
Ignis				
1.3	M13A	1328	09/00>	6737.82
1.3 DDiS	Z13DT	1248	09/03>	6835.88
1.5	M15 / M15A	1490	12/00>	6737.82
1.5 VVT	M15	1248	09/03>	6737.82
Jimny				
1.3	G13BB-E6	1298	09/98>	3328.88
1.5 DDiS	K9K	1298	09/03>	6666.89
Liana				
1.3	M13A	1328	06/01>	6737.82
1.6	M16A	1586	06/01>	6737.82
LJ80				
0.8 4WD	F8A	796	10/78>10/81	1416.82
	F8A	796	10/78>10/81	5075.82
Samurai				
1.0	F10A	970	09/86>	1416.82
1.3	G13	1324	09/86>	5075.82
	G13A	1325	09/86>	1416.82
	G13BAK	1298	01/95>	5075.82
Swift				
1.0	G10 / A	993	10/83>08/96	3328.88
	G10T	993	10/83>10/88	3328.82
1.3	G13A	1324	10/84>01/88	3328.82
	G13B / BA / BAK	1298	03/89>08/96	3328.88
1.3 16V	G13DOHC	1298	10/89>03/92	3328.88
1.3 4WD	G13BAK4WD	1298	03/89>03/92	3328.88
1.6	G16B	1590	01/90>03/92	3328.88
	M16A	1586	10/89>03/92	3328.82
Swift II NEW				
1.3 DDiS	Z13DT	1299	04/05>	6835.88
Vitara				
1.6	G16AC / G16AI / G16B	1590	09/89>03/98	6985.82
	M16A	1586	01/88>	5075.82
1.9 D	XUD9	1905	01/96>03/98	5130.83
2.0	H20A	1998	01/95>03/98	6985.82
2.0 TD	RF	1998	01/96>03/98	5980.88
Grand Vitara				
1.6	G16B	1995	05/98>	6737.82
1.9 DDiS	F9Q		01/95>03/98	6628.89
2.0 16V	J20A	1995	05/98>	6737.82
2.0 TD	RFM	1998	05/98>	5980.88
2.0 TDi / HDi	RHZ	1997	01/01>	5130.83
2.5 V6	H25A	2494	05/98>	6702.82
2.7 XL7 V6 24V	H27A	2737	03/01>	6702.82

PHOTOS PICTURES ZEICHUNGEN	
 1416	 3328
 5075	 5130
 5980	 6628
 6666	 6702
 6737	 6835
 6985	 NEW



VEHICULE MODEL FAHRZEUGTYP	MOTEUR ENGINE MOTOR	CYLINDRÉE ENGINE SIZE HUBRAUM	ANNÉE YEAR JAHR	VERNET
Wagon R / R+				
1.0 16V	K10A	997	03/97>	3328.82
1.2 16V	K12A	1171	09/98>	3328.82
1.3 16V	G13BB	1298	03/00>	3328.88
1.3 DDiS	13DDiS	1248	09/03>	6835.88
X90				
1.6 16V	G16BA	1590	11/95>	5075.82
	G16BA	1590	11/95>	1416.88

TALBOT

Bagheera

All models			01/75>12/78	1418.83
			01/79>	1529.83

Horizon

1.1	E1A / E1 / BTC / VP	1118	01/78>07/85	1418.83
	E1A / E1 / BTC / VP	1118	01/78>07/85	1529.89
1.3	G1 / G2	1294	01/78>07/85	1418.83
	G1 / G2	1294	01/78>07/85	1529.89
1.4	TALB04	1442	03/79>09/79	1418.83
	TALB04	1442	03/79>09/79	1529.89
	Y1 / Y2	1442	10/78>07/85	1418.83
	Y1 / Y2	1442	10/78>07/85	1529.89
1.6	J1B / J2A / J2S	1592	07/82>07/86	1529.89
	J1B / J2A / J2S	1592	07/82>07/86	1418.83
1.7 D	XUD7	1769	07/83>06/85	4947.81
	XUD7	1769	07/83>06/85	1418.83
	XUD7	1769	07/83>06/85	1529.89
1.9 D	XUD9	1905	07/82>06/86	4947.81
	XUD9	1905	07/82>12/86	1418.83
	XUD9	1905	07/82>12/86	1529.89

Murena

1.6		1592	05/80>	1529.83
2.2		2155	05/80>	1529.83

Rancho

1.5		1442	03/76>12/77	1418.83
		1442	01/78>12/79	1529.83
		1442	01/80>12/86	1335.87

Samba

1.0	XV5 / XV8	954	01/81>10/85	5108.83
1.1	XW7	1124	01/81>10/85	5108.83
1.2	XZ7R	1219	01/83>10/85	5108.83
1.4	XY6 / XY8 / XY7	1360	01/81>10/85	5108.83

Série 1000

All models			01/69>	1418.77
			01/79>	1529.83

Série 1300 / 1500 / Solara

1.3 / 1.5			09/75>12/77	1418.83
			01/78>12/79	1529.83
			01/80>	1529.89

Tagora

2.2	N2	2155	10/80>	1529.89
2.3 TD	XD2S	2304	10/80>	1503.80
2.6 V6	ZN	2664	10/80>	1183.83





LISTE D'APPLICATIONS

APPLICATION LIST/ANWENDUNGSLISTE

VEHICULE MODEL FAHRZEUGTYP	MOTEUR ENGINE MOTOR	CYLINDRÉE ENGINE SIZE HUBRAUM	ANNÉE YEAR JAHR	VERNET	PHOTOS PICTURES ZEICHNUNGEN
TOYOTA					
1000					
1.0	2K	993	04/69>02/78	1416.88	
	2K	993	04/69>02/78	6310.82	
	2K	993	11/75>02/78	6310.88	
1.2	3K-H	1166	07/77>08/81	6310.82	
	3K-H	1166	07/77>08/81	1416.88	
4 Runner					
2.0	3Y / Y-C	1998	03/84>08/85	6484.82	
2.2	4Y / Y-C / Y-E	2236	08/85>12/89	6484.82	
2.4	22R-EC	2366	12/87>12/89	6310.88	
2.4 D / TD	2L / L-T	2446	03/84>11/95	6312.88	
2.7	3RZ-FE	2694	11/95>08/00	6587.82	
3.0	3VZ-E	2959	08/89>11/95	6585.82	
3.0 TD	1KZ-T	2982	08/93>11/95	6520.82	
3.4	5VZ-FE	3378	11/95>	6295.82	
Avensis - Verso					
1.6	3ZZ-FE	1598	07/00>	6295.82	
	4A-FEC	1587	10/97>06/00	6484.82	
1.8	7A-FE	1762	10/97>06/00	6484.82	
1.8 VVTi	1ZZ-FE	1794	07/00>	6295.82	
2.0	3S-FE	1998	10/97>06/00	6484.82	
2.0 D-4	1AZ-FSE	1998	07/00>	6295.82	
	1AZ-FSE	1998	01/03>	6295.88	
2.0 D-4D	1CD-FTV	1995	08/99>	6311.82	
2.0 TD	2C-T / 2C-TE	1974	10/97>06/00	6484.82	
2.0 VVTi	1AZ-FE	1998	03/01>	6295.82	
	1AZ-FE	1998	03/01>	6295.88	
2.4 D-4D	2AZ-FSE	2362	09/03>	6295.82	
	2AZ-FSE	2362	09/03>	6295.88	
Aygo NEW					
1.0 VVT-i	1KR-FE	998	09/05>	6950.82	
1.4 D	2WZ-TV	1398	09/05>	6874.83	
Camry					
1.8	1S-L	1832	10/82>08/88	6484.82	
1.8 TD	1C-TL	1839	08/83>08/85	6484.82	
2.0	1AZ-FE	1998	08/01>	6295.82	
	2S-EL / ELC	1995	03/83>10/86	6484.82	
	3S-FE / FEC	1998	10/86>06/91	6484.82	
2.0 TD	2C-TL	1974	08/85>06/91	6484.82	
2.2	5S-FE	2164	06/91>07/01	6484.82	
2.4	2AZ-FE	2362	08/01>	6295.82	
2.5 V6	2VZ-FE	2507	02/88>06/91	6295.82	
3.0 V6	1MZ-FE	2995	08/96>07/01	6295.82	NEW
	3VZ-FE	2959	06/91>08/96	6295.82	
Carina					
1.6	2T / 4A	1588	03/71>12/87	6310.88	
	4A-F / FC / FEC	1587	12/87>12/97	6484.82	
1.8	1S-EL	1832	08/85>12/87	6310.88	
	3T / 3T-C	1770	08/81>09/83	6310.88	
	7A-FE	1762	12/94>12/97	6484.82	
1.8 D	1C	1839	04/82>09/83	6484.82	
2.0	2S-EL	1995	08/81>12/87	6310.88	
	3S-GE	1998	02/92>02/94	6295.82	
	3S-GE	1998	02/94>12/97	6583.82	
2.0 16V	3S-FE / FEC	1998	12/87>12/97	6484.82	
2.0 D	2C	1974	10/83>12/87	6310.88	
	2C	1974	12/87>12/97	6484.82	



LISTE D'APPLICATIONS

APPLICATION LIST/ANWENDUNGSLISTE

VEHICULE MODEL FAHRZEUGTYP	MOTEUR ENGINE MOTOR	CYLINDRÉE ENGINE SIZE HUBRAUM	ANNÉE YEAR JAHR	VERNET
...Carina				
2.0 TD	2C-T	1974	01/96>12/97	6484.82
	2C-T	1974	01/96>12/97	6583.82
Celica				
1.6	2T / 2T-B / 2T-G / 4A-L	1588	08/81>08/89	6310.88
	4A-FE / 4A-GE	1587	08/83>10/93	6484.82
1.6 16V	4A-GEL / GELC	1587	08/85>07/89	6484.82
1.8	1ZZ-GE / 2ZZ-GE	1796	08/00>	6295.82
	7A-FE	1762	11/93>07/99	6484.82
1.8 VVTi	1ZZ-FE / 2ZZ-FE	1794	08/99>	6295.82
2.0	18 R-C	1972	08/79>07/81	6310.82
	18R-G / 21R / R-C	1972	08/81>08/85	6310.88
	2S-C	1995	08/83>08/84	6484.82
	3S-GE / GTE	1998	10/89>10/93	6484.82
	3S-GE1 / GTE	1998	11/93>	6583.82
2.0 Turbo 4WD	3S-GEL / GTE	1998	08/85>08/89	6310.88
2.4	22R-EC	2366	08/84>07/85	6310.88
Corolla - Verso				
1.2	3K	1166	01/80>04/83	6310.88
1.3	2A-L / LC / 2E	1295	05/83>05/97	6484.82
	2E-E / L / LC	1295	08/84>05/92	6484.82
	4E-FE	1332	05/92>10/99	6484.82
	4K	1290	08/79>06/84	6310.82
	4K / 4K-C	1290	08/79>08/80	1416.88
	4K / 4K-C	1290	08/79>09/83	6310.88
1.4	4ZZ-FE	1398	10/99>	6295.82
1.4 D-4D	1ND-TV	1364	08/04>	6311.82
1.6	2T / 2T-B / 2T-G	1588	08/79>06/84	6310.88
	2T-G	1588	08/79>11/80	6310.82
	4A-C / 4A-FE	1587	05/83>04/97	6484.82
	4A-L / LC	1587	05/83>09/87	6484.82
1.6 16V	4A-GEC / GEL / GELC	1587	08/83>09/87	6484.82
1.6 VVTi	3ZZ-FE	1598	10/99>	6295.82
1.8	3T / 3T-C	1770	08/79>04/84	6310.88
	7A-FE	1762	11/92>04/97	6484.82
1.8 / 1.8 VVTi	1ZZ-FE / 2ZZ-GE	1796	09/01>	6295.82
1.8 D	1C	1839	10/82>05/84	6310.88
	1C / C-L	1839	05/83>05/92	6484.82
1.9 D	1WZ	1868	12/99>10/01	5130.83
2.0 D	2C / C-E	1974	05/92>	6484.82
2.0 D-4D	1CD-FTV	1995	09/02>04/05	6295.82
	1CD-FTV	1995	08/00>	6311.82
Corona				
1.6	4A	1587	10/83>	6484.82
1.8	3T	1832	01/82>08/85	6310.88
2.0	3S	1998	08/85>11/87	6484.82
2.0 D	1C / 2C	1974	01/82>11/87	6484.82
Cressida				
1.8	3T	1770	07/81>	6310.88
2.0	18R	1968	07/81>	6310.88
	21R / R-C	1972	09/80>07/84	1416.88
2.2 D	L	2188	09/80>07/84	6312.88
2.8	5M-E	2759	09/80>	1416.88



1416



5130



6295



6310



6311



6312



6484



6583



LISTE D'APPLICATIONS



















APPLICATION LIST/ANWENDUNGSLISTE

VEHICULE MODEL FAHRZEUGTYP	MOTEUR ENGINE MOTOR	CYLINDRÉE ENGINE SIZE HUBBRAUM	ANNÉE YEAR JAHR	VERNET	PHOTOS PICTURES ZEICHNUNGEN	
Dyna						
100 - 1.8	2Y	1812	08/85>08/87	6312.88	 1416	
	2Y	1812	08/85>08/87	6484.82		 6295
100 - 2.4 D	2L	2446	05/95>08/01	6484.82	 6310	
	2L	2446	08/85>08/87	6312.88		 6311
	2L	2446	08/87>04/95	6312.88		
Hiace						
1.6	12R / 12R-M	1587	02/77>03/83	1416.88	 6310	
	12R / 12R-M	1587	02/77>03/83	6310.82		 6311
1.8	2Y / 2Y-C	1812	12/82>08/86	6484.82	 6312	
2.0	18R / 18R-C	1968	02/77>03/83	6310.88		 6484
	1RZ	1998	08/89>07/95	6311.82		
	3Y	1998	06/83>08/89	6484.82		
2.2	4Y	2236	08/86>08/89	6484.82	 6312	
2.2 D	L	2188	01/79>03/83	6312.82		 6484
2.4	2RZ-E	2438	08/89>07/95	6311.82	 6520	
	2RZ-E	2438	08/95>	6587.82		 6525
2.4 D / TD	2L / 2L-T	2446	08/89>	6312.88	 6583	
2.5 D	2L	2446	01/84>07/95	6312.88		 6585
2.5 D-4D	2KD-FTV	2494	08/01>	6520.82	 6587	
2.7	3RZ-FE	2694	04/98>	6587.82		
Hilux						
1.6	12R / 12R-M	1587	08/78>07/83	1416.88	 6520	
	12R / 12R-M	1587	08/78>07/83	6310.82		 6525
	1Y / Y-C	1626	08/83>12/90	6484.82		
1.8	2Y / Y-C	1812	08/83>07/98	6484.82	 6583	
2.0	18R / 18R-C	1968	08/78>07/83	1416.88		 6585
	18R / 18R-C	1968	08/79>07/83	6310.82		
	3Y / Y-C	1998	08/83>01/92	6484.82		
2.2	4Y / Y-C	2236	08/85>08/94	6484.82	 6587	
2.2 D	L	2188	08/83>08/94	6312.88		
2.4	2RZ-FE	2438	08/97>08/01	6587.82	 6583	
2.4 4WD	22R / R-E	2366	01/86>08/97	6310.88		 6585
2.4 D / TD	2L / 2L-T	2446	08/88>08/01	6312.82		
2.5 D	2L	2446	08/83>	6312.88	 6587	
2.5 D-4D	2KD-FTV	2494	08/01>	6520.82		
3.0	3VZ-E	2959	08/89>	6585.82	 6583	
3.0 TD	1KZ-T / TE	2982	05/93>	6520.82		
Land Cruiser						
2.4	22R / R-E	2366	11/84>04/96	6310.88	 6583	
2.5 D / TD	2L / L-T	2446	11/84>01/95	6312.88		
2.5 TD	3B-VM66A	2494	10/85>02/94	6525.88	 6583	
3.0 D	B	2977	08/80>10/84	6525.82		
3.0 D-4D	1KD-FTV	2982	09/02>08/04	6520.82	 6583	
3.0 TD	1KZ-T / TE	2982	05/93>09/02	6520.82		
3.4 D	3B	3431	08/80>10/87	6525.82	 6583	
	3B / 13B-T	3431	08/80>01/90	6525.88		
3.4 TD	1PZ	3470	01/90>08/92	6583.76	 6583	
3.4 V6	5VZ-FE	3378	04/96>09/02	6295.82		
4.0	1GR-FE	3956	01/03>08/04	6520.82	 6583	
4.0 D	2H / 12H-T	3980	11/84>01/90	6525.88		
4.2 D / TD	1HZ / 1HD-FT / FTE / T	4164	01/90>	6583.76	 6583	
4.5	1FZ-FE	4477	08/92>01/98	6583.82		
4.7	2UZ-FE	4664	01/98>08/02	6583.82	 6583	



LISTE D'APPLICATIONS



APPLICATION LIST/ANWENDUNGSLISTE

VEHICULE MODEL FAHRZEUGTYP	MOTEUR ENGINE MOTOR	CYLINDRÉE ENGINE SIZE HUBRAUM	ANNÉE YEAR JAHR	VERNET	PHOTOS PICTURES ZEICHUNGEN
Liteace					
1.3	4K / K-C	1290	10/79>07/88	1416.88	 1416
	4K / K-C	1290	10/79>07/88	6310.88	
1.5	5K	1486	10/85>01/95	6310.88	 6295
	5K	1486	01/92>	6310.82	
1.8 D	1C	1839	10/85>08/88	6484.82	 6310
2.0 D	2C	1974	01/92>01/95	6484.82	
2.2	4Y-EC	2236	01/92>01/95	6484.82	 6311
MR 2					
1.6	4A-GELC	1587	11/84>10/89	6484.82	 6310
1.8 VVTi	1ZZ-FE	1794	07/00>	6295.82	
2.0	3A	1998	04/86>11/89	6484.82	 6311
	3S-FE / GE	1998	12/89>12/99	6295.82	
	4A-GEL / GELC	1998	04/86>11/89	6484.82	 6484
2.0 16V	3S-GEC / GEW	1998	12/89>12/93	6295.82	
2.2	5S-FE	2194	12/89>06/95	6295.82	 6587
Modèle F					
1.8	2Y / Y-C	1812	11/82>01/84	6484.82	 6484
2.0	3Y / Y-C	1998	01/84>01/90	6484.82	
2.0 D	2C	1974	05/83>08/88	6484.82	 6587
2.2	4Y-EC	2236	08/85>01/90	6484.82	
Paseo					
1.5 16V	5E-FE	1496	12/95>02/98	6484.76	 6484
	5E-FE	1496	08/95>07/99	6484.82	
Pic nic					
2.0	3S-FEC	1998	09/96>05/01	6484.82	 6311
2.0 D-4D	1CD-FTV	1995	05/01>	6311.82	
2.0 VVTi	1AZ-FE	1998	05/01>	6295.82	 6484
2.2 TD	3C-TE	2184	09/97>05/01	6484.82	
Previa					
2.0 D-4D	1CD-FTV	1995	01/02>	6311.82	 6587
2.4	2TZ-FE	2438	05/90>01/00	6587.82	
2.4 VVTi	2AZ-FE	2362	01/02>	6295.82	 6484
Prius					
1.5	1NZ-FXE	1497	05/00>	6311.82	 6587
RAV4					
1.8 VVTi	1ZZ-FE	1794	00/05>	6295.82	 6484
2.0 4WD	3S-FE / FEC	1998	04/94>07/00	6484.82	
2.0 4WD 16V	1AZ-FE	1998	08/00>	6295.82	 6587
2.0 D-4D	1CD-FTV	1995	05/01>	6311.82	
2.0 VVTi	1AZ-FE	1998	00/05>	6295.82	 6484
Starlet					
1.0	1E / E-L	999	10/84>12/92	6484.82	 6310
	2K	993	02/78>10/84	6310.82	
	2K	993	02/78>12/92	6310.88	 6311
1.2	3K-C / K-H	1166	07/78>09/84	6310.82	
	3K-C / K-H	1166	07/78>10/84	6310.88	 6484
1.3	2E / E-E / 2E-L	1295	10/84>12/95	6484.82	
	4E-FE	1332	01/96>07/99	6484.82	 6310
	4K	1290	08/82>09/84	6310.82	
	4K-C	1290	08/81>10/84	6310.88	 6484
1.5 D	1N	1453	12/86>12/95	6484.82	
Supra					
2.8	5M-E / GE	2759	12/81>12/85	6310.88	 6310











LISTE D'APPLICATIONS

APPLICATION LIST/ANWENDUNGSLISTE

VEHICULE MODEL FAHRZEUGTYP	MOTEUR ENGINE MOTOR	CYLINDRÉE ENGINE SIZE HUBRAUM	ANNÉE YEAR JAHR	VERNET	PHOTOS PICTURES ZEICHUNGEN
...Supra					
3.0	2JZ-GE / GTE	2997	05/93>05/96	6311.82	
	7M-GE / GEK	2954	01/86>04/93	6310.88	
3.0 Turbo	7M-GTE / GTEK	2954	01/86>04/93	6310.88	
Tercel					
1.3	2A	1295	05/82>08/84	6484.82	
1.5	3A / A-C	1452	08/82>01/88	6484.82	
Yaris - Verso					
1.0	1SZ-FE	998	01/99>	6876.80	
1.3	2NZ-FE	1299	06/99>	6311.82	
1.3 VVTi	2SZ-FE	1298	05/02>	6876.80	
1.4 D-4D	1ND-TV	1364	12/01>	6311.82	
1.5 VVTi	1NZ-FE	1497	01/01>	6311.82	

VOLKSWAGEN

Bora							
1.4 16V	AHW / AKQ / APE / AXP / BCA	1390	09/98>05/05	6274.87			
1.6	AEH / AKL / APF	1595	09/98>05/05	6276.87			
	APF	1595	05/99>	5973.80			
	APF / AVU / BFQ	1595	05/99>05/05	6976.00			
	ATN / AUS / AZD / BCB	1595	08/99>05/05	6274.87			
1.6 FSi	BAD	1595	08/01>05/05	6274.87			
1.8	AGN	1781	05/99>10/00	6975.00			
	ARX / AUQ	1781	09/00>05/05	6276.87			
1.8 20V	AGN / AGU / AUM	1781	02/99>05/05	6276.87			
1.9 SDi	AGP	1896	09/98>04/01	6273.87			
1.9 TDi	AGR / AHF	1896	09/98>05/05	6273.87			
	AJM / ARL	1896	05/99>05/03	6975.00			
	AJM / ARL	1896	05/99>05/03	6976.00			
	ALH / AJM	1896	09/98>05/05	6273.87			
	ASZ / ARL / ATD / AUY / AXR	1896	05/00>05/05	6273.87			
	ASZ / ATD / AUY	1896	05/00>05/02	6975.00			
	ASZ / ATD / AUY	1896	05/00>05/03	6976.00			
	2.0	APK / AQY	1984	09/98>		6276.87	
		AZH / AZJ	1984	04/00>05/05		6276.87	
		AZH / AZJ	1984	04/00>05/03		6975.00	
AZH / AZJ		1984	04/00>05/03	6976.00			
2.3	AGZ / AQN	2324	09/90>04/99	5973.80			
	AGZ / AQN	2324	05/99>05/03	6975.00			
	AGZ / AQN	2324	05/99>05/03	6976.00			
2.3 V5	AGZ	2324	09/98>	6273.87			
2.8	AQP / AUE / BDE	2792	05/99>05/03	5973.80			
	AQP / AUE / BDE	2792	05/99>05/03	6975.00			
	AQP / AUE / BDE	2792	05/99>05/03	6976.00			
Corrado							
1.8	KR / PG	1781	09/88>07/91	1439.87			
2.0	ADY / 2E / 9A	1984	08/91>07/95	1439.87			
2.9 VR6	ABV	2861	08/91>07/95	5973.80			
Derby							
0.9	HA	895	01/77>07/78	1410.87			
	HA	895	07/78>09/81	1410.92			
1.1	HB / HD	1093	01/77>07/78	1410.87			
	HB / HD	1093	07/78>09/81	1410.92			





LISTE D'APPLICATIONS

APPLICATION LIST/ANWENDUNGSLISTE



















VEHICULE MODEL FAHRZEUGTYP	MOTEUR ENGINE MOTOR	CYLINDRÉE ENGINE SIZE HUBRAUM	ANNÉE YEAR JAHR	VERNET
...Derby				
1.3	HH / HJ	1272	01/77>07/78	1410.87
	HH / HJ	1272	07/78>09/81	1410.92
Fox NEW				
1.4 TDi	BNM	1399	06/05>	6273.87
Golf I				
1.1	FA / FJ	1093	04/74>07/78	1410.87
	FA / FJ / GG	1093	08/78>07/83	1410.92
	GG	1093	08/79>07/83	1439.87
1.3	GF	1272	08/79>07/83	1410.92
	HK	1272	08/83>07/86	1439.87
1.5	EH / GH / JB	1457	08/77>07/83	1439.87
	EH / JB	1457	08/77>07/78	1439.80
	FH	1471	09/74>12/75	6276.87
	FK / FH	1471	02/74>07/75	1439.80
	JB	1457	08/78>07/83	1410.92
1.5 D	CK	1471	08/76>07/78	1439.80
	CK	1471	08/78>07/80	1439.87
1.6	EG / EE	1588	02/76>07/78	1439.80
	EW	1595	08/83>07/86	1410.92
	EW	1595	08/83>07/92	1439.87
	FN / FP / FT / FV	1588	01/76>07/78	1439.80
	FN / FV / EM	1588	01/76>07/81	1439.87
	HN	1595	08/83>07/86	1439.87
1.6 D / TD	CR / CY	1588	08/80>08/83	3349.87
	JK / CR / CY	1588	08/80>07/83	1439.87
1.7	EN	1716	08/80>07/83	1439.87
1.8	2H / KT	1781	08/83>07/93	1439.87
	EX / JH / DX	1781	08/83>08/93	1439.87
	KT	1781	08/86>12/87	5151.84
Golf II				
1.0	GN / HZ	1043	08/83>07/86	1410.92
	HZ	1043	05/85>10/91	5151.84
1.3	2G	1272	01/89>10/91	1439.87
	2G	1272	01/89>10/91	5151.84
	GT / HK / HW / MH	1272	08/83>07/86	1410.92
	MH / NU / NZ	1272	08/86>10/91	5151.84
1.6	AEK / AFT / AKS	1595	07/94>12/97	1439.87
	EZ / HM / PN / RF	1595	08/83>10/91	1439.87
1.6 D	1V / JP / ME	1588	08/83>10/91	3349.87
1.6 TD	JR / MF / RA / SB	1588	08/83>10/91	3349.87
1.8	1H / 1P / PG	1763	08/88>07/91	1439.87
	AAM / ABS / ADZ / ANP	1781	09/93>02/98	1439.87
	EV / GZ / HT	1781	01/84>07/88	1439.87
	GU / GX / RH	1781	01/84>07/91	1439.87
	HV / PF / RP / RV	1781	01/84>	1439.87
	PB / PG / RD / PF	1781	08/85>10/91	1439.87
	1.8 16V	KR / PL	1781	02/86>10/91
1.9 TDi	1Z / AFN / AHU / ALE	1896	08/95>12/97	3349.87
2.0	2E / ADY / AGG / AKR	1984	09/93>12/97	1439.87
Golf III				
1.4	ABD	1391	11/91>07/95	5151.84
	AEX / APQ	1390	07/95>05/98	6274.87





LISTE D'APPLICATIONS

APPLICATION LIST/ANWENDUNGSLISTE

VEHICULE MODEL FAHRZEUGTYP	MOTEUR ENGINE MOTOR	CYLINDRÉE ENGINE SIZE HUBRAUM	ANNÉE YEAR JAHR	VERNET	PHOTOS PICTURES ZEICHNUNGEN
...Golf III					
1.6	ABU	1598	09/92>09/94	5151.84	 1439  3349
	AEA	1598	10/94>06/95	3349.87	
	AEA	1598	10/94>06/95	6273.87	
	AEK / AFT / AKS	1598	11/91>10/00	1439.87	
1.8	ABS / ACC / AAM	1781	11/91>10/00	1439.87	 5151  5973
	ADZ / ANP / AMM / ANN	1781	11/91>10/00	1439.87	
1.9 D	1Y	1896	11/91>12/97	3349.87	 6273  6274
	1Y	1896	08/93>02/99	6273.87	
1.9 SDi	AEY	1896	01/95>12/97	3349.87	 6276  6434
1.9 TD	AEY	1896	01/95>12/97	6273.87	
1.9 TDi	AAZ	1896	11/91>12/97	3349.87	 6975  6976
	AAZ	1896	07/93>02/99	6273.87	
1.9 TDi	1Z / AHU / AFN / ALE	1896	06/93>12/01	3349.87	 6975  6976
	AFN / AHU / ALE / AVG	1896	03/98>	6273.87	
2.0	2E / ADY / AEP /				 6975  6976
	AGG / AKR	1984	11/91>12/01	1439.87	
	ATU / AWF / AWG	1984	06/99>04/02	1439.87	
2.0 16V	ABF	1984	03/92>12/97	6434.82	 6975  6976
2.8 VR6	AAA	2792	01/92>12/97	5973.80	
2.9 VR6	ABV	2861	01/94>04/99	5973.80	
Golf IV					
1.4	AHW	1390	05/00>	6276.87	 6975  6976
	AHW / AKQ / APE	1390	10/97>05/00	6274.87	
	AXP	1390	05/00>10/01	6273.87	
	BCA	1390	10/01>	6274.87	
1.6	AEH	1595	05/00>	6273.87	 6975 6976
	AEH / AKL / APF	1595	10/97>06/02	6276.87	
	APF / AVU / BFQ	1595	05/99>	6976.00	
	AUS / BCB	1595	05/00>	6274.87	
1.6 FSi	BAD	1595	08/01>	6274.87	 6975 6976
1.8	AGN	1781	05/99>10/00	6975.00	
	AGN	1781	05/99>10/00	6976.00	
	ARZ / AUM / AUC	1781	05/99>	6276.87	
1.8 20V / 20V Turbo	AGN / AGU	1781	10/97>	6276.87	 6975 6976
1.9 SDi	AGP / AQM	1896	10/97>	6273.87	
1.9 TDi	AGR / AHF / ALH / AJM	1896	10/97>	6273.87	
	AGR / AJM / ARL	1896	05/99>	6975.00	
	AGR / AJM / ARL	1896	05/99>	6976.00	
	ARL / ASZ / ATD	1896	05/99	6273.87	
	ASV / AXR	1896	05/00	6273.87	
	ASZ / ATD / AUJ	1896	01/00>	6975.00	
	ASZ / ATD / AUJ	1896	01/00>	6976.00	
	AUJ	1896	01/00>07/01	6273.87	
	2.0	APK / AQY	1984	08/98>	6276.87
AZG / BEH		1984	05/01>04/02	6276.87	
AZH		1984	04/00>06/01	6276.87	
AZH / AZJ		1984	04/00>	6975.00	
AZH / AZJ		1984	04/00>	6976.00	
2.3	AGZ / AQN	2324	05/99>	6975.00	 6975 6976
	AGZ / AQN	2324	05/99>	6976.00	
	AQN	2324	09/00	5973.80	
2.3 VR5	AGZ	2324	10/97>02/01	6273.87	



LISTE D'APPLICATIONS

APPLICATION LIST/ANWENDUNGSLISTE











VEHICULE MODEL FAHRZEUGTYP	MOTEUR ENGINE MOTOR	CYLINDRÉE ENGINE SIZE HUBRAUM	ANNÉE YEAR JAHR	VERNET
...Golf IV				
2.8	AQP	2792	05/99>05/00	5973.80
	AQP / AUE / BDE	2792	05/99>	6975.00
	AQP / AUE / BDE	2792	05/99>	6976.00
	AUE	2792	01/00>04/01	6276.87
	BDE	2792	05/01>	5973.87
3.2	BFH	3189	06/02>05/04	5973.87
Golf V / Golf Plus				
1.4	BCA	1390	10/03>	6274.87
1.4 FSi	BKG	1390	10/03>12/04	6965.00
	BLN	1390	07/05>	6274.87
1.6	BGU	1595	01/04>05/05	6276.87
	BSF / BSE	1595	05/05>	6276.87
1.6 FSi	BAG / BLP	1598	10/03>02/05	6965.00
	BLF	1598	01/05>	6965.00
1.9 TDi	BJB / BKC / BRU	1896	10/03>05/05	6273.87
	BLS	1896	08/05	6273.87
2.0 FSi	AXW	1984	10/03>07/04	6864.105
	AXX	1984	09/04>	6977.00
	BLR / BLX / BLY	1984	10/03>	6864.105
2.0 SDi	BDK	2000	01/04>	6273.87
2.0 TDi	AZV / BKD	1968	10/03>	5962.88
	BMM / BMN	1968	12/04>	6273.87
Jetta I				
1.1	GG	1093	08/80>02/84	1410.92
1.3	GF / GS	1272	08/82>02/84	1410.92
	HK	1272	08/83>07/85	1439.87
1.5	GH / JB	1457	08/78>02/84	1439.87
1.6	BSE		09/05>	6276.87
	EM / FR / EG / EJ / HN	1588	08/80>02/84	1439.87
1.6 D / TD	CR / CY / JK	1588	03/82>02/84	1439.87
1.7	EN	1716	08/80>07/84	1439.87
1.8	DX / JJ	1781	08/82>02/84	1439.87
1.9 TDi	BKC		09/05>	6273.87
2.0 FSi	BLY		09/05>	6864.105
2.0 TDi	BKD		09/05>	5962.88
Jetta II				
1.0	HZ	1043	08/86>10/91	5151.84
1.3	2C / MH / NZ / NU	1272	02/87>07/92	5151.84
	GT / HW / MH	1272	08/83>07/87	1410.92
	HK	1272	08/83>07/85	1439.87
1.6	EZ / HM / PN / RF	1595	08/86>07/92	1439.87
1.6 D	1V / JP / ME	1588	08/83>07/92	3349.87
1.6 TD	JR / MF / RA / SB	1588	08/83>10/91	3349.87
1.8	1P / GU-K / RD	1781	08/85>07/91	1439.87
	EV / PB / RH	1781	01/84>10/91	1439.87
	GU / GX / GZ / HV / RE	1781	01/84>10/91	1439.87
	PF / RP / RV	1781	01/87>10/91	1439.87
1.8 16V	KR / PL	1781	02/86>10/91	1439.87
Lupo				
1.0	AHT / ALL / AER	999	10/98>05/00	6274.87
	ALD / AUC	999	05/99>07/05	6274.87
	ANV	999	05/99>05/00	6273.87
1.2 TDi	ANY / AYZ	1191	05/99>05/03	6273.87





LISTE D'APPLICATIONS



APPLICATION LIST/ANWENDUNGSLISTE

VEHICULE MODEL FAHRZEUGTYP	MOTEUR ENGINE MOTOR	CYLINDRÉE ENGINE SIZE HUBRAUM	ANNÉE YEAR JAHR	VERNET	PHOTOS PICTURES ZEICHNUNGEN
...Lupo					
1.4	AFK / AHW / AKQ APE / AQQ / AUA / AUD / AUB / BBY	1390	10/98>07/00	6274.87	 1410
1.4 FSi	ARR	1390	05/99>07/05	6274.87	 1439
1.4 TDi	AMF	1422	05/99>07/05	6273.87	
1.6	AVY	1598	06/00>07/05	6274.80	
1.7 SDi	AKU	1716	10/98>07/05	6273.87	
Multivan NEW					
1.9 TDi	AXB	1899	01/06>	6273.87	
2.0	AXA	1999	01/06>	6276.87	 3349
2.5 TDi	AXE	2499	01/06>	6966.87	 5968
3.2	BDC	3199	01/06>	6533.80	
New Beetle					
1.4	BCA	1390	08/01>	6274.87	
1.6	AWH / AYD / BFS	1595	11/99>	6276.87	
1.8	APH / AVC AWP / AWU / AWV BKF	1781	01/99>10/00 06/00> 07/04>06/05	6276.87 6276.87 6276.87	 5973
1.9 TDi	ALH / ATD BEW / BSW	1896	11/98>06/05 07/05>	6273.87 6273.87	 6273
2.0	AEG / APQ / AQY / AZJ / BEJ BER / BEV / BHP	1984	01/98> 01/03>	6276.87 6276.87	 6274
2.3	AQN	2324	10/00>06/05	5973.80	 6276
Passat I					
1.3	FZ / FY ZA / ZF ZA / ZF	1272	01/78>07/81 05/73>01/78 05/73>07/77	1410.92 1439.80 1439.87	
1.5	CK / YJ / ZB / ZC / FF / FL YJ / ZB / ZC / FF / FL	1471	05/73>12/75 05/73>12/75	1439.87 1439.80	 6533
1.5 D	CK	1471	08/77>07/80	1439.87	 6966 NEW
1.6	FS / YG / YH / YN / YP FS / YK / YT / YU WP / WV / WY / WZ YG / YH / YN / YP YK / YS / YT / YU / YY	1588	02/76>07/81 09/75>07/78 09/79>07/81 09/75>07/78 09/75>07/81	1439.87 1439.80 1439.87 1439.80 1439.87	
1.6 D	CR	1588	08/80>07/81	1439.87	
1.6 D / TD	CR / CY	1588	08/81>07/82	3349.87	
1.9	WN	1921	01/81>07/81	5968.87	
2.2	WE	2144	01/81>07/81	5968.87	 6968 NEW
Passat II					
1.3	EP / EU FY / FZ	1297	08/83>04/88 08/81>07/83	1439.87 1410.92	
1.6	DT / JU / PP DTA WV / WY / YP	1595	08/84>04/88 01/85>04/88 08/81>04/88	1439.87 1439.87 1439.87	
1.6 D / TD	CR / CY / JK	1588	08/81>04/88	3349.87	
1.8	DS / JN / JV RM	1781	08/83>04/88 08/86>03/88	1439.87 1439.87	
1.9	WN	1921	08/81>07/84	5968.87	
2.0	HP / JS	1994	08/83>07/88	5968.87	
2.2	WE	2144	08/81>07/83	5968.87	
2.3	HY / JT / KV / KX	2226	08/84>07/88	5968.87	



LISTE D'APPLICATIONS

APPLICATION LIST/ANWENDUNGSLISTE

VEHICULE MODEL FAHRZEUGTYP	MOTEUR ENGINE MOTOR	CYLINDRÉE ENGINE SIZE HUBRAUM	ANNÉE YEAR JAHR	VERNET	PHOTOS PICTURES ZEICHUNGEN
Passat III					
1.6	1F / EZ / RF	1595	04/88>09/91	1439.87	
1.6 TD	RA / SB	1588	06/88>10/93	3349.87	
1.8	9A / AAM	1984	08/90>10/93	1439.87	
	PB / PF / PG / RP	1781	04/88>10/93	1439.87	
1.8 16V	ABS / KR	1781	04/88>10/93	1439.87	
1.9 D / TD	1Y / AAZ	1896	08/88>10/93	3349.87	
2.0	2E	1984	03/90>10/93	3349.87	
	2E	1984	10/91>10/93	5973.80	
	2E / AAW / ACX	1984	08/89>10/93	1439.87	
2.0 16V	9A	1984	04/88>10/93	1439.87	
2.8	AAA	2792	06/91>10/93	5973.80	
	AAA	2792	08/91>10/93	3349.87	
Passat IV					
1.6	AEK / AFT	1598	10/94>12/96	1439.87	
1.6 S-97	AADP / AHL	1595	10/96>	6276.87	
1.8	AAM / ABS / ADZ	1781	10/93>12/96	1439.87	
1.8 S-97	ADP / ADR / AEE / AFY	1781	10/96>	6276.87	
1.9 TD	AAZ	1896	10/93>12/96	3349.87	
1.9 TDi	1Z / AFN / AHU	1896	10/93>12/96	3349.87	
2.0	ACX / ADY / AEP / AGG	1984	03/94>05/97	1439.87	
2.0 16V	ABF / 2E	1984	10/93>12/96	1439.87	
2.8 VR6	AAA	2792	10/93>12/96	5973.80	
2.9 VR6	ABV	2861	01/94>05/97	5973.80	
Passat V					
1.6	ADP / AHL / ANA / ARM	1595	10/96>08/00	6276.87	
1.8	ADR / AFY / APT / ARG	1781	12/96>12/98	6276.87	
1.8 20V Turbo	AEB / ANB / APU	1781	10/96>08/00	6276.87	
1.9 SDi	AHH	1896	08/97>08/00	3349.87	
1.9 TDi	AFN / AHH / AHU / AJM	1896	10/96>08/00	6273.87	
	AFN / AHU	1896	10/96>	3349.87	
	ATJ	1896	01/00>08/00	3349.87	
2.3	AGZ	2324	09/97>08/98	6276.87	
2.3 VR5	AGZ	2324	07/99>08/00	6273.87	
2.5 TDi V6	AFB / AKN	2496	08/98>08/00	5902.87	
2.8	AQD	2771	01/99>04/99	6276.87	
2.8 V6	AGE	2771	05/97>04/99	5902.87	
2.8 V6 / V6 30V	AGE / APR / AQD / ATX	2771	04/99>08/00	6533.92	
2.8 V6 30V	ACK / ALG / APR / AQD	2771	05/97>04/99	5902.87	
Passat VI					
1.6	ALZ	1595	10/00>05/05	6276.87	
1.8	AWM / AWT	1781	10/00>05/05	6276.87	
1.9 TDi	AVB / AVF / AWX	1896	10/00>05/05	6273.87	
2.0	ALT	1984	11/01>05/05	6842.100	
	AZM	1984	10/00>05/05	6276.87	
2.0 TDi	BGW	1968	11/03>05/05	6273.87	
2.3	AZX	2324	01/01>05/05	5973.80	
2.5 TDi	AKN / BAU / BDH / BDG	2496	10/00>05/05	5902.87	
2.8	AMX / ATQ	2771	10/00>05/05	6533.92	
	BBG	2784	10/00>05/05	6533.92	
Passat VII NEW					
1.6	BSE / BSF	1595	05/05>	6276.87	
1.6 FSi	BLF	1598	09/05>	6965.00	
1.9 TDi	BKC / BLS	1896	03/05>	6273.87	
2.0 FSi	BLR / BLX / BLY	1984	03/05>11/05	6864.105	
	BLR / BLX / BLY	1984	03/05>11/05	6977.00	



1439



3349



5902



5973



6273



6276



6533



6842



6864



6965

NEW























6977

NEW



LISTE D'APPLICATIONS

APPLICATION LIST/ANWENDUNGSLISTE

VEHICULE MODEL FAHRZEUGTYP	MOTEUR ENGINE MOTOR	CYLINDRÉE ENGINE SIZE HUBRAUM	ANNÉE YEAR JAHR	VERNET	PHOTOS PICTURES ZEICHNUNGEN
...Passat VII					
2.0 TDi	BKP / BMA / BVE	1968	03/05>	5962.88	 1410  1439
	BMP / BMR / BVD / BUZ	1968	03/05>	5962.88	
	BMP / BVD	1968	03/05>	6273.87	
2.0 TFSi	AXX / BPY / BWA	1984	03/05>	6977.00	
Polo I					
0.8	HE	800	01/76>07/78	1410.87	
0.9	HA	895	04/75>09/81	1410.87	
1.1	HB	1093	04/75>07/81	1410.92	 3349  5151
	HC / HD	1093	04/75>07/78	1410.87	
1.3	HH / HJ	1272	01/77>09/81	1410.92	
Polo II					
1.0	GL	1043	10/81>10/90	1410.92	 5962  6273
	HZ	1043	08/85>07/86	5151.84	
1.1	HB	1093	10/81>07/83	1410.92	
1.3	GK / GT	1272	08/82>10/90	1410.92	 6274  6276
	HH / HJ / HK / HW	1272	10/81>07/85	1410.92	
	MH	1272	08/85>07/86	5151.84	
Polo III					
1.0	AAK / HZ	1043	08/86>10/90	5151.84	 6965  6977
	GL	1043	08/86>10/90	1410.92	
1.3	2G / PY / MH	1272	08/86>10/90	5151.84	 6977  NEW
	3F / NZ / NU	1272	08/86>10/90	5151.84	
	GK / GT	1272	08/86>10/90	1410.92	
1.3 D	MN	1272	08/86>10/90	5151.84	
Polo IV					
1.0	AAU / HZ	1043	10/90>10/94	5151.84	
1.3	2G / 3F / NZ	1272	10/90>10/94	5151.84	 6965  NEW
	AAV / PY / PYK	1272	10/90>10/94	5151.84	
1.4 16V	AFH / AEX	1390	07/95>	6274.87	
1.4 D	1W	1391	10/90>10/94	5151.84	
Polo V					
1.0	AER	999	07/96>12/99	6274.87	 6965  NEW
	AEV	1043	10/94>06/96	3349.87	
1.3	ADX	1296	10/94>07/95	3349.87	
1.4	AEX / AFH	1390	07/95>10/99	6274.87	
1.6	1F / AFT	1598	05/96>09/99	1439.87	 6977  NEW
	AEA	1598	10/94>07/95	3349.87	
	AEE / AHS	1598	07/95>12/99	6274.87	
1.7 SDi	AHG / AKU	1716	10/99>	6273.87	
1.9 D	1Y	1896	01/95>04/98	3349.87	
1.9 SDi	AEY / AGD	1896	05/96>09/99	3349.87	
1.9 TDi	AGR / ALH / ASV	1896	10/99>	6273.87	 6977  NEW
	AHU	1896	01/97>09/99	3349.87	
Polo VI					
1.6	AEH / AUR / AKL / APF	1595	10/99>09/01	6276.87	
1.7 SDi	AKU	1716	10/99>04/00	6273.87	
1.8	ADD	1781	03/00>09/01	1439.87	
1.9 D	AEF	1896	10/99>07/01	6273.87	
1.9 SDi	AGD / AGP / AQM	1896	10/99>09/01	6273.87	
1.9 TDi	AGR / ALH / ASV	1896	10/99>09/01	6273.87	
2.0	ADC	1984	06/00>09/01	1439.87	
Polo VII					
1.2	AWY / AZQ	1198	11/01>07/04	6965.00	



LISTE D'APPLICATIONS

APPLICATION LIST/ANWENDUNGSLISTE

VEHICULE MODEL FAHRZEUGTYP	MOTEUR ENGINE MOTOR	CYLINDRÉE ENGINE SIZE HUBRAUM	ANNÉE YEAR JAHR	VERNET
...Vento				
1.8	AAM / ABS / ADZ	1781	11/91>12/97	1439.87
1.9 D / TD	1Y / AAZ	1896	11/91>12/97	3349.87
1.9 SDi	AEY	1896	07/95>12/97	3349.87
1.9 TDi	AFN / AHU / ALE / 1Z	1896	08/93>12/97	3349.87
2.0	2E	1984	11/91>07/95	1439.87
	ADY / AEP / AGG / AKR	1984	10/94>12/97	1439.87
2.8	AAA	2792	01/92>12/97	5973.80

VOLKSWAGEN



Caddy

1.4	AEX / AKV / APQ / BCA	1390	11/95>	6274.87
1.5	JB	1457	08/82>07/83	1439.87
1.6	1F	1595	11/95>05/97	1439.87
	AEE	1598	06/96>12/00	6274.87
	BGU	1595	04/04>05/05	6276.87
	EM / EW / HN	1588	08/82>07/92	1439.87
1.6 D	JK	1588	08/82>07/90	3349.87
1.7 SDi	AHB	1716	07/96>09/00	6273.87
1.8	JH	1781	08/85>07/90	1439.87
1.9 D	1Y	1896	11/95>06/03	6273.87
	AEF	1896	06/96>12/00	3349.87
1.9 SDi	AEY	1896	11/95>09/00	6273.87
1.9 TDi	AHU / ALE	1896	12/96>09/00	6273.87
	BJB	1896	02/04>	6273.87
2.0 SDi	BDJ	1968	02/04>	6273.87
	BDJ	1968	02/04>	6274.87

LT

2.0	CH / CL	1984	04/75>11/82	1400.83
2.0 4x4	DL	2383	07/89>07/91	5973.80
	DL	2383	08/85>07/91	5973.87
2.3	AGL	2295	05/96>11/01	6285.87
2.4	DL	2383	07/89>07/92	5973.80
	DL / HS / 1E	2383	12/82>07/92	5973.87
2.4 D	1S / ACT	2383	08/89>12/95	5973.80
	ACT / DW / 1S	2383	12/82>12/95	5973.87
	CP	2383	01/79>11/82	5902.87
2.4 TD	1G / ACL / DV	2383	07/89>12/95	5973.80
	1G / ACL / DV	2383	12/82>12/95	5973.87
2.5 SDi	AGX	2460	05/96>04/01	5968.87
2.5 TD	AHD / ANJ	2460	05/96>04/02	5968.87
2.5 TDi	AHD	2460	05/96>05/99	5973.80
	AHD	2460	05/96>04/97	5973.80
	AHD / ANJ / APA	2460	05/96>	5968.87
2.7 D	CG	2710	01/76>03/80	6524.82

Taro

1.8 4x2	2Y	1812	02/89>09/94	6484.82
2.2 4x4	4Y	2236	06/89>07/94	6484.82
2.4 4x4	22R-EC	2366	06/89>03/97	6310.88
2.4 D 4x2	2L	2446	02/89>03/97	6312.88

PHOTOS PICTURES ZEICHNUNGEN	
1400	1439
3349	5902
5968	5973
6273	6274
6276	6285
6310	6312
6484	6524



LISTE D'APPLICATIONS

APPLICATION LIST/ANWENDUNGSLISTE

VEHICULE MODEL FAHRZEUGTYP	MOTEUR ENGINE MOTOR	CYLINDRÉE ENGINE SIZE HUBRAUM	ANNÉE YEAR JAHR	VERNET
Touran				
1.6	BGU	1595	07/03>05/05	6276.87
1.6 FSI	BAG	1598	02/03>05/04	6965.00
1.9 TDi	AVQ / BKC	1896	02/03>	6273.87
2.0 FSi	AXW	1984	10/03>	6864.105
2.0 TDi	AZV / BKD	1968	02/03>	5962.88
Transporter				
1.6 D / TD	CS / JX	1588	05/79>09/91	3349.87
1.6 TD	JX	1588	08/84>09/91	1439.80
1.7 D	KY	1715	10/86>07/91	3349.87
1.8	PD	1781	09/90>07/92	3349.87
1.9	DF / DG / DH	1915	08/82>07/91	6523.87
	EY / GW / SP	1915	03/83>07/91	6523.87
1.9 D / TD	1X / ABL	1896	09/90>12/95	3349.87
1.9 TD	ABL	1896	01/96>06/03	6273.87
1.9 TDi	AXB / AXC	1896	04/03>	6273.87
2.0	AAC	1968	09/90>12/95	3349.87
	AAC	1968	09/90>07/91	5968.87
	AAC	1968	01/96>06/03	6273.87
	AXA	1984	06/03>	6276.87
2.1	DJ / MV / SR / SS	2109	08/85>09/91	6523.87
2.4 D	AAB	2370	09/90>06/03	5973.80
	AAB / AJA	2370	09/90>06/03	5968.87
2.5	AAF	2460	09/90>12/93	3349.87
	AAF / ACU / AEN	2460	09/90>06/03	5968.87
	AAF / ACU / AET	2460	11/90>05/97	5973.80
	AET / AEU	2460	05/97>06/03	5968.87
	APL / AVT	2460	05/97>06/03	5968.87
2.5 TDi	ACV	2460	05/98>11/99	6273.87
	ACV / AXL	2460	01/96>06/03	5968.87
	AJT	2500	05/98>10/01	5968.87
	AXD / AXE / BJJ	2460	04/03>	6966.87
2.8	AES	2792	01/96>06/03	5973.80
	AMV	2800	05/00>04/01	6273.87
3.2	BDL / BKK	3189	05/03>	6533.80

VOLVO



Amazon				
1.6	B16	1588		1343.87
1.8 / 2.0	B18 / B20	1731	01/61>10/73	1420.82
120 / 140 / 160				
1.2		1196	10/67>06/74	1514.88
1.4		1397	10/67>06/74	1514.88
1.6		1596	06/68>06/74	1514.88





LISTE D'APPLICATIONS

APPLICATION LIST/ANWENDUNGSLISTE

VEHICULE MODEL FAHRZEUGTYP	MOTEUR ENGINE MOTOR	CYLINDRÉE ENGINE SIZE HUBRAUM	ANNÉE YEAR JAHR	VERNET	PHOTOS PICTURES ZEICHNUNGEN
240 / 260					
2.0	B19	1985	01/74>08/93	4856.88	 1183
2.1	B21	2127	01/74>08/93	4856.88	 1417
2.1 Turbo	B21T	2127	10/80>08/93	4856.88	
2.3	B23	2316	01/74>08/93	4856.88	
2.4 D	D24	2383	10/78>08/93	1535.87	
2.7	B27	2664	09/74>12/80	1183.87	
2.8	B28	2849	01/81>08/93	1183.87	
340 / 360					
1.4	B14	1397	02/76>07/91	4495.89	 1535
1.6 D	D16	1595	07/84>07/90	1417.89	 4495
1.7	B17	1721	10/85>07/91	4495.89	
1.9	B19	1986	09/79>08/82	4856.88	
2.0	B19A / E B200E / K	1986 1986	09/82>06/84 07/84>07/89	4856.88 4856.88	
440 / 460 / 480					
1.6	B16F	1596	10/91>06/97	6318.92	 4561
1.7	B18E / ED / EP B18EP / FP / K / KP B18F / FP / K / KP	1721 1721 1721	10/88>06/97 10/88>10/92 10/88>06/97	5108.89 6318.92 5108.89	 4856
1.7 Turbo	B18FT / FTM	1721	04/88>10/92	5108.89	
1.8	B18U / U-200	1794	10/91>06/97	6318.92	
1.9 TD	D19T / TEGR D19T / TEGR D19TEGR D19TEGR	1870 1870 1870 1870	01/95>06/97 01/95>06/97 07/94>06/97 07/94>12/94	5108.89 6045.89 5083.83 5757.89	 5083
2.0	B20F	1998	10/92>06/97	6318.92	 5108
740 / 760 / 780					
2.0	B200E / FG / / K B204GT / GT	1986 1986	07/84>08/94 07/85>07/90	4856.88 4856.92	 5757
2.0 16V	B204E	1986	08/88>07/90	4856.88	 5968
2.0 Turbo	B200ET / FT	1986	07/84>07/92	4856.88	
2.0 Turbo 16V	B204FT / GT	1986	07/89>07/90	4856.88	
2.3	B230A / E / F / FB B230G / K / FTX	2316 2316	07/85>08/94 08/84>08/94	4856.88 4856.88	
2.3 16V	B234F	2316	07/89>07/90	4856.88	
2.3 Turbo	B230ET / FT / GT	2316	08/84>07/90	4856.88	
2.4 D	D24	2383	07/84>08/94	1535.87	
2.4 TD	D24T / TIC	2383	07/85>08/94	1535.87	
2.8	B280E / EC / F / FC	2849	07/82>10/90	1183.87	
850					
2.0 10V / 20V	B5202F / 4F / 4T	1984	06/91>12/96	4561.92	
2.3 Turbo	B5234S / T / T5	2318	03/93>12/96	4561.87	
2.5 10V / 20V	B5252F / B5254F / T	2435	06/91>12/96	4561.92	
2.5 TDi	D5252T	2461	02/96>12/96	5968.87	
940 / 960					
2.0	B200	1986	09/90>	4856.88	
2.0 16V / 16V Turbo	B204 / T	1991	09/90>	4856.88	
2.3	B230	2316	09/90>	4856.88	
2.3 16V	B234	2316	09/90>	4856.88	
2.4 D	D24	2383	09/90>	1535.87	
2.4 TD	D24TIC	2383	09/90>	1535.87	
2.8 V6	B280	2849	09/90>	4561.87	
3.0	B290	3922	09/90>	4561.87	



LISTE D'APPLICATIONS

APPLICATION LIST/ANWENDUNGSLISTE

VEHICULE MODEL FAHRZEUGTYP	MOTEUR ENGINE MOTOR	CYLINDRÉE ENGINE SIZE HUBRAUM	ANNÉE YEAR JAHR	VERNET
C70				
2.0 Turbo	B5204T2 / T3 / T4	1984	03/97>	4561.92
2.3 Turbo	B5234T3-	2319	03/97>	4561.92
2.4 Turbo	B5254T / B5244S	2435	03/97>09/02	4561.92
2.5 Turbo	B5254S / B5244T	1984	01/98>	4561.92
S40				
1.6 16V	B4164S / S2 / D3	1588	01/97>03/04	4561.92
1.8 16V	B4184S / S2 / S3 / D3	1731	10/95>03/04	4561.92
	B4184SM	1731	03/98>03/04	5434.82
1.9 T 16V T4	B4194T	1948	05/97>07/00	4561.92
1.9 TD	D4192T	1870	07/96>08/99	5108.89
1.9 TDCi	D4192T3 / T4	1870	07/00>03/04	5108.89
1.9 TDi	D4192T2	1870	01/99>07/00	4168.89
2.0 16V	B4204S / S2	1948	10/95>03/04	4561.92
2.0 T 16V Turbo	B4204T / T3 / T5	1948	11/97>07/00	4561.92
S40 II				
1.6			09/05>	6837.82
1.6 D			09/05>	6875.83
2.0 D	D4204T	1998	03/04>	6756.84
	D4204T	1998	03/04>	4561.92
2.4 20V	B5244S4 / S5	2435	03/04>	6881.90
T5	B5254T3	2521	03/04>	6881.90
S60				
2.0 20V Turbo	B5204T5	1984	08/00>12/01	4561.92
2.3 20V Turbo	B5234T3 / T7	2318	08/00>12/01	4561.92
2.4 20V	B5244S / S2 / SG / T3	2435	08/00>	4561.92
2.4 20V Turbo	B5244T3	2435	08/00>	4561.92
2.4 D	D5244T	2401	06/01>	6865.90
2.4 D5	D5244T2	2401	06/01>03/05	6865.90
2.4 T5 / R	B5254T4 / B5244T5	2401	02/04>	6866.90
2.5	B5254T2 / B5254T4	2521	03/03>03/04	6866.90
S70				
2.0	B5202FS	1984	12/96>04/99	4561.92
	B5202T2 / T3 / T4	1984	12/96>11/00	4561.92
2.3 S70R / S70T5	B5234T3 / T4	2318	12/96>11/00	4561.92
2.3 Turbo	B5234FS / T2 / T7	2318	12/96>11/00	4561.92
2.4	B5244S / S2 / SG2 / T	2435	05/99>11/00	4561.92
2.5 10V / 20V	B5252FS / S / T	2435	12/96>04/99	4561.92
2.5 TDi	D5252T	2461	12/96>11/00	5968.87
2.5 Turbo	B5254T	2435	12/96>04/99	4561.92
	GB5252S / S2	2435	12/96>04/99	4561.92
S80				
2.0 T5	B5204T3 / T4 / T5	1984	06/98>	4561.92
	B5204T3 / T4 / T5	1984	06/98>03/04	6866.90
2.0 Turbo	B5204T4	1984	06/98>	4561.92
2.4	B5244S / S2 / SG	2435	06/98>	4561.92
	B5244S / S2 / SG	2435	06/98>	6865.90
	B5244T3	2435	08/00>03/04	6866.90
2.4 D	D5244T2	2401	07/01>	6865.90
2.4 TDi D5	D5244T	2401	07/01>	6865.90
2.5 TDi	D5252T	2461	06/98>	5968.87
2.8	B6284T	2783	06/98>	6867.90
2.9	B6294S2 / B6304S3	2922	06/98>	6867.90
3.0	B6294T	2922	06/01>	6867.90
S90				
3.0	B6304S1 / S2	2922	09/96>	4561.92



4168



4561



5108



5434



5968



6756

NEW



6837



6865



6866



6867



6875

















6881



LISTE D'APPLICATIONS

APPLICATION LIST/ANWENDUNGSLISTE

VEHICULE MODEL FAHRZEUGTYP	MOTEUR ENGINE MOTOR	CYLINDRÉE ENGINE SIZE HUBRAUM	ANNÉE YEAR JAHR	VERNET	PHOTOS PICTURES ZEICHNUNGEN
V40					
1.6 16V	B4164S / S2 / D3	1588	05/97>	4561.92	
1.8 16V	B4184S / S2 / S3 / D3	1731	10/95>	4561.92	
	B4184SM	1731	03/98>	5434.82	
1.9 T4 16V	B4194T	1948	05/97>07/00	4561.92	
1.9 TD	D4192T	1870	06/96>08/99	4168.89	
1.9 TDi	D4192T2	1870	01/99>	5108.89	
2.0 16V / 16V Turbo	B4204S / S2 / T	1948	10/95>	4561.92	
V50					
1.6			09/05>	6837.82	
1.6 D			09/05>	6875.83	
2.0 D 16V	D4204T	1998	03/04>	4561.92	
	D4204T	1998	03/04>	6756.84	
2.4 20V	B5244S4 / S5	2435	03/04>	6881.90	
2.5 T5	B5254T3	2521	03/04>	6881.90	
V70					
2.0	B5202FS	1984	12/96>06/98	4561.92	
	B5204T2 / T3 / T4 / T5	1984	01/00>12/02	4561.92	
	B5204T5	1984	01/02>03/04	6866.90	
2.3 T5	B5234T3-E2	2319	01/02>03/04	6866.90	
2.3 Turbo / T5	B5234T2 / T3 / T4 / T6	2318	12/96>06/98	4561.92	
2.4 10V / 20V	B5252S / 4S	2435	12/96>06/98	4561.92	
2.4 D	D5244T2 / T7	2401	01/00>	6865.90	
2.4 T5	B5244T5 / T3	2435	01/02>03/04	6866.90	
2.4 TDi	D5244T5	2401	01/00>	6865.90	
2.4 Turbo 20V	B5244S / S2 / SG	2435	01/03>	6865.90	
	B5244S / S2 / SG2 / T3	2435	05/99>12/02	4561.92	
	B5252FS	2435	12/96>12/99	4561.92	
	B5254FS / T	2435	12/96>06/98	4561.92	
2.5 T	B5254T2 / T5	2521	01/02>03/04	6866.90	
2.5 TDi	D5252T	2461	12/96>12/99	5968.87	
2.5i AWD	B5254FS / T4	2521	12/96>12/02	4561.92	
	B5254T2 / T4	2521	01/03>	6866.90	
D5	D5244T	2401	01/00>	6865.90	
V90					
3.0	B6304S1 / S2	2922	09/96>	4561.92	
XC70					
2.0	B5204T3	1984	12/97>12/99	4561.92	
2.3	B5234T7	2318	01/00>	4561.92	
2.4	B5244T / T3	2435	12/97>	4561.92	
2.4 D	D5244T2	2401	08/02>	6865.90	
2.5	B5254T	2521	12/97>12/02	4561.92	
2.5 T	B5254T2	2521	01/02>03/04	6866.90	
D5	D5244T	2401	08/02>	6865.90	
XC90					
2.4 D	D5244T2	2401	05/02>	6865.90	
2.4 TD	D5244T	2401	05/02>	6865.90	
2.5	B5254T2	2521	05/02>12/02	4561.92	
2.5 T	B5254T2	2521	05/02>03/04	6866.90	
2.9i 24V	B6294T	2922	05/02>	6867.90	
YUGO - ZASTAVA					
101					
1.0		988	12/74>	3905.82	
Yugo 45					
0.9		903	01/86>12/85	1473.88	
		903	08/91>06/95	1522.78	



VEHICULE
MODEL
FAHRZEUGTYP

VERNET

PHOTOS
PICTURES
ZEICHUNGEN

CATERPILLAR

D 3		1309.82
D 7 E	à partir de 47 A 1737 et de 48 A 2809	CT16957.82 x 2
D 7 F	61 G, 90R	CT13555.82
D 8 H	à partir de 36 A 4469 et de 46 A 7096	CT16957.82 x 2
D 8 K	à partir de 17 S	CT16957.82 x 2
D 9	99 J, 91 J et à partir de 66 A 4228	CT16957.82 x 2
619	à partir de 61 F 528 et 62 F 194	CT16957.82 x 2
621	23 H	CT16957.82 x 2
627	50 K, 54 K, 68 M, 69 M	CT16957.82
630 B	à partir de 14 G 1	CT16957.82 x 2
631 B	à partir de 13 G 1	CT16957.82 x 2
632	à partir de 14 G 1	CT16957.82 x 2
633	44 J, 66M	CT16957.82 x 2
637	65 M, 79 P 64 M, 91 N, 92 N	CT16957.82 x 2 CT16957.82
641	à partir de 64 F 1, 41 M, 65 K	CT16957.82 x 2
650	à partir de 63 F 1, 77 F, 58 K	CT16957.82 x 2
651	à partir de 33 G 1, 67 K, 44 M	CT16957.82 x 2
657	à partir de 19 G 1, 20 G 1, et 31 G 1, 68 K, 46 M, 47 M, 53 K	CT16957.82 x 2
660	à partir de 77 F 1, et de 90 F 1, 58 K	CT16957.82 x 2
666	à partir de 19 G 1, et de 20 G 1, 77 F, 64 H - 32 G	CT16957.82 x 2
773	63 G	CT16957.82 x 2
824, 825	à partir de 29 G 1, 43 E	CT16957.82 x 2
834, 835	43 N, 44 N, 36 H	CT16957.82 x 2
16	à partir de 46 G 1	CT16957.82 x 2
910	à partir de 80 U 1	1309.82
931		1309.82
966 B	à partir de 75 A 1	CT16957.82 x 2
980	à partir de 42 H 1 Série B 89 P	CT16957.82 x 2 CT16958.76 CT16957.82
983		CT16958.76 x 2
988	87 A 1, 78 P	CT16957.82 x 2
988 B	à partir de 50 W	CT16957.82 x 2
992	25 série K	CT16958.76 x 3
571	à partir de 64 A 72	CT16957.82 x 2
572 E	à partir de 65 A 65	CT16957.82 x 2
583 H	à partir de 61 A 87	CT16957.82 x 2
D 333 B	à partir de 79 B 1	CT16957.82
D 342 C	à partir de 31 B 3617, et de 49 B 647	CT16957.82 x 2
D 353	à partir de 77 B 1	CT16957.82 x 2
D 379	à partir de 68 B 1	CT16957.82 x 4
G 379	à partir de 72 B 1	CT16957.82 x 4
D 330	à partir de 57 B 1 et de 86 B 1	CT16957.82
D 330 A	à partir de 51 B 1	CT16957.82
D 330 B	à partir de 82 B 1	CT16957.82
D 333	à partir de 59 B 1	CT16957.82
D 333 B	à partir de 82 B 1	CT16957.82
D 379	à partir de 69 B 1	CT16957.82 x 4
D 398	à partir de 67 B 1, et de 76 B 888 à partir de 66 B 700, de 73 B 1 et de 75 B 1	CT16957.82 x 4 CT16957.82 x 4
G 398	à partir de 73 B 1	CT16957.82 x 4
D 3400	à partir de IN 7001	1309.82 x 2

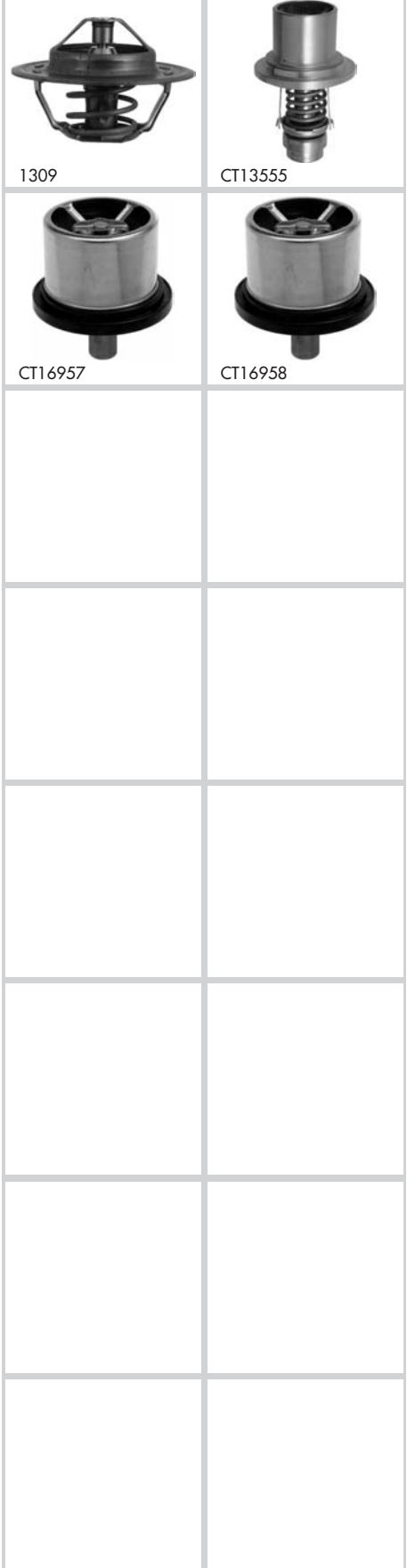



LISTE D'APPLICATIONS

APPLICATION LIST/ANWENDUNGSLISTE

VEHICULE MODEL FAHRZEUGTYP	VERNET	PHOTOS PICTURES ZEICHUNGEN
D 4400 à partir de IN 4001	1309.82 x 2	 1309  1378
D 4600 à partir de IN 1	1309.82 x 2	
769 à partir de 99 F 1	CT16957.82 x 2	 1439  3348
D 348 57 K, 98 N	CT16957.82 x 4	
1140 à partir de 36 B 1	1439.80 x 2	 3356  CT13555
1145 à partir de 97 B 1	1439.80 x 2	
1150 à partir de 96 B 1	1439.80 x 2	 CT16850  CT16957
1160 à partir de 95 B 1	1439.80 x 2	
1673 à partir de 74 B 109	CT16957.82	
1673 B 69 D et à partir de 78 B 1	CT16957.82	
1674 94 B	CT16957.82	
1676 54 B	CT16957.82 x 2	
1693 à partir de 65 B 1	CT16957.82 x 2	
3204 1309.82		
3116 / 3208 1439.80 x 2		
3176 / 3406 / 3408 / 3412 / 3508 / 3512 / 3516	CT16957.82	
<h2>CUMMINS</h2>		
Diesel		
"B" Série 4 Cyl / 6 Cyl - 102	3356.83	
"C" Série 4 Cyl / 6 Cyl - 114	4 Cyl (Types B, BI, I, IP) C-90, C-105, C-140	3348.83
	6 Cyl (Types B, BI, CI, I, IP, P, G) C-160, CF-160, CR-160,	1378.83
	C-175, C-180, C-190, C-200, C-240	CT16850.82
"J" Série 4 Cyl (Types B, BI, I, IP, P, G) J-70, J-80, J-120	1378.83	
"H" Série 4 à 6 Cyl (Types B, BI, CI, I, IF, P, G) H, HA, HB, HF, HHR, HHRF, HHRS, HR, HRC, HRF, HRS, HS, H-135, H-160, HU-170	CT16850.82	
"J" Série 6 Cyl (Types B, BI, CI, I, IP, P, G) J, JF, JN, JNF, JNR, JNS, JS, JT, JT-10, JT-15, JT-20, JN-130, JNF-130, JNR-100	CT16850.82	
"L" Série L, LR, LRT	1309.82 x 3	
"N" Série 4 à 6 Cyl (Types B, BI, CI, I, IP, P, G) NFT, NRT, NRTO, NT, NTC, NTE, NTO, NT-165, NT-180, NT-200, NTC-230, NTC-235, NT-280, NT-300, NT-310, NT-335, NTC-250, NTC-290, NTC-335, NTC-350, NT-370, NT-380, NT-400, NT-420, NT-855, N-927, 270	CT16850.82	
"N" Série 300 D, Formule 230, 250, 290, L 10		
"NH" Série 5 à 6 Cyl (Types B, BI, CI, I, IP, P, G) NH, NHC, NHE, NHS, NHRS, NH-160, NH-180, NHE-180, NH-195, NHE-195, NH-200, NH-220, NHE-220, NHE-225, NHF-240, NH-230, NH-250, NHC-250, NHCT-270	CT16850.82	
"NHH" Série 4 à 6 Cyl (Type B, BI) NHH, NHHs, NHHRS, NHHRT, NHHRTO, NHHHT, NHHTO, NHH-180, NHH-220, NTA-350, NTA-370, NTA-400, NTA-420, NTA-855	CT16850.82	
V6-130 B, V6-140 B, V6N-140 B, V6-155, V8E-170 B, V8-185 B, V8N-185 B, V6E-195 B, V6E-195 BI, V6-200 B, V8-210, V8E-235 B, V8E-235 BI, V8-265 B, V6-352	CT13555.82	
V6R-180 C, V8-185 CI, V6-200 CI, V8R-240 CI, V8/265 CI, V8-265 IP, V8-555, VT-555, VTF-555, V12-400 CI	CT16850.82	
V903, VT903, VT903 M	CT16850.82	
V12-525 BI, V12-525 CI, V12-525I, V12-525 G, VT12-550 BI, VT12-600 G, VT12-700 BI, VT12-700 CI, VT12-700I, VT12-700G	CT16850.82	
"NVH" Série 12 Cyl (Type BI, CI, G) NVH, NVHS, NVH-450	CT16850.82	
"K" Série KT-450, KT-1150, KTA-1150	CT16850.82	
KT-2300, KTA-2300	CT16850.82	



VEHICULE
MODEL
FAHRZEUGTYP

VERNET

PHOTOS
PICTURES
ZEICHUNGEN

DAF

Moteurs

DE 385 / BA 475 / BB 475 / DA 475 / DD 475 / DD 575 / DF 615 / DT 615	5243.76
DBH 825 / DH 825 / DU 825 / DK 1160 (212 PS) / DKA 1160 (230 PS) / DKD 1160 / DKD 1260 / DKDL 1260	5241.76
DHS 825 / DHT 825 / DHTD 825 / DKA 1160 (260 PS) / DKL 1160 (205 PS) / DKS 1160 (320 PS) / DKS 1160 E (280 PS) / DKT 1160 (290 PS) / DKTD 1160 / DKX 1160 (330 PS) / DKDL 2160 / D 2800	5239.75
TYPE 95	CT16050.79
FA 700 DE	5243.76
FA 900 DE, DD, DT, BDT	5243.76
FA 1200 DA, DD, DF, FT 1200 DF	5243.76
FA 1300 DF	5243.76
FA 1400 DF, DT, FT 1400 DF, DT	5243.76
F 1600, FA 1600 DF, DT, DTD, DSD	5243.76
FT 1600 DF, DT	5243.76
FA 1800 DT, FAV 1800 DT	5243.76
F 2000, FA 2000 DH, DHB	5243.76
FM 2000 DH, FT 2000 DH, DHB	5243.76
FA 2100 DH, DHT, DHTD	5239.75
FA 2105 DHT, DHTD	5239.75
FA 2200 DU, FAR 2200 DU	5243.76
FAT 2200 DU	5243.76
FMT 2200 DU, FT 2200 DU	5243.76
FA 2300 DHT, FT 2300 DHT	5239.75
FAG 2305 DHT, FAT 2335 DHT	5239.75
A 2400 KD-420	5243.76
AS 2400 DK-505 / 548	5243.76
ATE 2400 DK-464	5243.76
T 2400 DK-335 / 370	5243.76
V 2400 DK-430	5243.76
FA 2500 DHS, FT 2500 DHS	5239.75
FAR 2500 DHS	5239.75
FAG 2505 DHS	5239.75
FAT 2525 DHS	5239.75
AS 2600 DKA-140	5243.76
AT 2600 DKS-460	5243.76
FA 2600 DK / DKA	5243.76
FAS 2600 DK / DKA	5243.76
FAT 2600 DKA	5243.76
FT 2600 DK / DKA	5243.76
FTS 2600 DK / DKA	5243.76
FTT 2600 DKA	5243.76
P 2600 DKA-310 / 360	5243.76
PS 2600 DKA-310	5243.76
TT 2600 DKA-350	5243.76
FA 2800, FA 2800 DKS, DKSE, DKTD	5239.75
FT 2800, FT 2800 DKS, DKSE, DKTD	5239.75
FAR 2800 DKS, DKSE, DKTD	5239.75
FAT 2800 DKS, DKTD	5239.75
FTT 2800 DKS, DKTD	5239.75
FT 2805 DKSE, DKTD	5239.75
FA 3300 DKX, FT 3300 DKX	5239.75
FAR 3300 DKX	5239.75



5239



5241



5243



CT16050









LISTE D'APPLICATIONS

APPLICATION LIST/ANWENDUNGSLISTE

VEHICULE MODEL FAHRZEUGTYP	VERNET	PHOTOS PICTURES ZEICHUNGEN
FT 3305 DKX	5239.75	 1508  1513
FAT 3325 DKX, FTT 3325 DKX	5239.75	
FTT 3326 DKX	5239.75	
IVECO (FIAT, OM, UNIC, MAGIRUS)		
Série S		
Daily 30.8, 35.8, 35.10 jusqu'à moteur 12030	3309.79	 3309  5239
Idem jusqu'au moteur 12031	3309.79	
Daily, Grinta 30.8, Autobus jusqu'à moteur 156337, 28, 30, 32, 35, 40.8, 35.8 1ère série et 2ème série, 30.8 1ère série et 2ème série jusqu'au moteur 9411	3309.74	
Daily, Grinta 40 NC / 35, 40.10 4x4 Turbo, 28, 30, 32, 35, 40.8, 40.10, 40.10 W (4x4), 45, 45.10, 49.10 Turbo jusqu'au moteur 12030	3309.79	
Série Z		
50, 55, 60.8, 79, 80, 90, 100.13, A 90.13, 79, 95, 109.14, A 90.14, 109.14, 50.8, 50.9, 55.8, 65.9, 60.11, 65.12, 79.12, 79.13, 79.14, 95.14, 109.14, Zeta, Turbo Zeta	3309.79	 CT1294
80.13, 80.14, 80.16, 110.14 P (4x4), 110.14, 115, 135.14, 135.17, 145.17, 175.17, 140.20, 120.13, 115.17 1ère série	3309.79	
159.20	3309.79 x 2	
160.26, 170, 180, 190.26	3309.79 x 2	
170, 190.20 jusqu'au moteur 9065	3309.79 x 2	
190.30 jusqu'au moteur 161910	1513.75	
190.30, 240.30, 220.30, Turbo star, 190.33	1513.75 x 2	
240.36 Turbo star, 220.36 PT 6 x 2, 240.36, 190.36 Turbo star, 170, 190.35, 190, 220, 240.38, 190.42, 170.33, 170.35, 330.36	1513.75 x 2	
190.32	1513.75	
190.26 HW, 330.26 H	3309.79 x 2	
190.26 NPAC, 260.26 H, HT, HW, PC, 330.26 H, PT, N, NW, PAC	3309.79 x 2	
190.30 H, 260.30 H, 330.30, N, NT, 190 PC 3013.75		
Eurotec, 480.10.21, 480.12.2113.80		
330.36 H / HT / HW jusqu'au moteur 80386	1513.75	
FIAT 40 NC - 40 NC 35 - 50 NC - 55 NC - 65 PC - 75 PC - 90 NC - 90 PC - 100 NC - 100 EC - 160 NC - 160 NR - OM - 40 - 40.35 - N 100 - 160 - OM 50 - 55 - 65 - 65.60 - 70 - 75 - 80 - 90 N 100.10	3309.79	
FIAT 100 EC - 110 NC - NR - NT - PC - OM 110 - 110 R - 110 P - 110 T	3309.79	
FIAT 130 NR 20 - NT 20 - 150 NC 17 - NC 20 - NR 20 - NT 20 - OM 130 R 20 - T20 - 150.20 - 150 R 20	3309.79	
OM 150.17 - 190 UNIC - 260 UNIC - 260 T UNIC13.71		
FIAT 159 NC 20 - NR 20	3309.79 x 2	
Orsetto / Orsetto	1508.84	
FIAT 170 NC 26 - 26 P - NT 26 - 190 NC 26 - 180 NC - NT - NTS - 300 PC - PT - OM 170.26 - 26 P - T 26 - T 26 P - 190.26 - 26 P - 300 P - T	3309.79 x 2	
616 N 1 - N 2 - N 2.4 - N 3 - N 3.4 - 619 N - N 1 - N 1 P - T - T1 - T1 P - 625 N - N 1 - N 2 - N 3 - 645 N 3 - 650 N 2 - N 3 - E 1 - 655 N - N 1 - 662 N 2 - N 2 P - N 3 - N 3 P - N 3 PR - T - 671 N 3 - 684 N - NP - T - TP	3309.79	
639 N - N 2 - N 3 - 642 N 6 - N 65 - 642 N 2 - 643 - N - T1 - E - EP - 682 N 4 - 683 N - N 3 - N 4 - T - T1 - 690 N 2	CT1294.79	
Bus		
315.8.13 - 316.8.13 - 315.8.17	3309.79	
370.10.20 jusqu'au moteur 9065	3309.79	
370.12.26, 308, 308 L, 314/2, 314/3, 315, 316, 331, 343, 409 A, 416, 418, 420, 421	3309.79 x 2	
370.10, 11, 12.25, 370.12.35, 370.12.25 L, 12.3013.80		









VEHICULE MODEL FAHRZEUGTYP	VERNET	PHOTOS PICTURES ZEICHUNGEN
309 Moteur 220 H - 331 - 409	CT1294.79	 1309
JOHN DEERE		 1378
Tracteurs		
50	1309.82	
60 + 60 H N. 6 026 000 - 6 042 999 / Moteur essence N. 6 030 927 - 6 054 499 + tous les autres	CT13555.82 1309.82	
60 S Moteur essence N. 6 025 000 - 6 030 926 + N. 6 043 000 - 6 054 499 + tous les autres	CT13555.82 1309.82	 1513
60 - 0 Moteur essence N. 6 025 000 - 6 030 926 + tous les autres	CT13555.82 1309.82	 3309
70/70 H/70 S jusqu'à N. 7 031 299 à partir de N. 7 031 299	CT13555.82 1309.82	
70 D/70 DS/70 DH	1309.82	
4030 / 4430 / 4620 / 4630	CT13555.82	
JD 540 / JD 540 - A / JD 544 / JD 544 - A / JD 570 / JD 570 - A	1309.87	
JD 644 / JD 644 - A / JD 690 / JD 690 - A	CT13555.82	
80	1309.82	 5792
320/330/420/420 C/430/430 C / 435/440/4401/4401 C/350 A	1378.83	 CT1294
520 / 530 / 620 / 630 / 720 / 730	1309.82	
820 / 830 / 840	1309.82 x 2	
1010 / 1010 C / 1010 CA / 1020 / 1520 / 2010 / 2010 C / 2020 / 2030 / 2510 / 2520	1378.83	
2130	5792.83	 CT13555
3010 / 3020	1309.82	
4000 / 4010 / 4020 / 4230 / 5010 / 5020	1309.82 x 2	
4520 / 8010	CT13555.82	
JD 300 / JD 301 / JD 310 / JD 350 / JD 350 B / JD 400 / JD 401 / JD 401 A / JD 410 / JD 440 / JD 440 A / JD 450 / JD 450 B / JD 480	1378.83	
JD 500 / JD 500 - A / JD 500 B / JD 500 - C / JD 510	1309.82	
JD 600 / JD 700 / JD 700 - A / JD 760 / JD 760 - A	1309.82 x 2	
Série 400 6404 D	1309.82 x 2	
40 / 45 / 55 / 55 R / 65 / 95	1378.82	
MAN		
D 0022 M	1378.80	
D 0224 MF / D 0226 MF / MKF	1513.80	
D 0824 FL 01 / LFL 01 / LFL 02 / D 0826 LFL 03 / LFL 06	1513.80	
V - D 2530 M / ME / MF / MKF / MT / MTE / MX / MTXF / ME - TME / MTE - TME	1513.80	
V - D 2538 M / ME / MF / MH / MKF / MT / MTE / MTF / MTH / MX / ME - TME / MTE - TME	1513.80	
D 2540 MTF	1513.80	
D 2542 ME - TME / MTE - TME / MLE13.80		
D 2555 M / ME / MF / MAF / MT / MX / MXF / MXUH / MXUL / MXE - TME / R - D2555 / M / R 5 D2555 MF	1513.80	
D 2556 M / ME / MF / MK / MT / MTE / MUH / TME / R 6 D 2556 M / MF / HF / RD 2556 MF / HF	1513.80	
D 2565 M / MF / MSF / MUH / MUL / MF 168 / MFG / ME - TME	1513.80	
D 2566 M / ME / MF / MK / MK 280/MKIL/MKF/MFG/MSF/MT/MTF / MTFG / MTE / MTUH / MUH / MUM / MUL / MX / TME / UH / MXE - TME	1513.80	
D 2840 MF	1513.80	
D 9622 / D 9624 M	1378.80	
6.90 / 8.90 / 8.103 / 8.136 / 9.136 / 9.153 / 10.136 / 10.153 / 12.136 / 12.170 / 12.192 / 13.168 / 13.192 / 14.136 / 14.168 / 14.170 / 14.192 / 14.220 / 14.240 / 15.168 / 15.192 / 15.200 / 15.220 / 15.240 / 16.136 / 16.168 / 16.170 / 16.192 / 16.200	1513.80	



LISTE D'APPLICATIONS

APPLICATION LIST/ANWENDUNGSLISTE

VEHICULE MODEL FAHRZEUGTYP	VERNET	PHOTOS PICTURES ZEICHUNGEN
16.220 / 16.240 / 16.256 / 16.320 / 19.240 / 19.280 / 19.281 / 19.291 / 19.321 / 19.331 / 19.361 / 20.240 / 20.280 / 20.281 / 20.291 / 20.320 / 20.321 / 20.331 / 20.361 / 22.192 / 22.200 / 22.220 / 22.240 / 22.281 / 22.291 / 22.320 / 22.321 / 22.331	1513.80	 1309
22.361 / 26.240 / 26.281 / 26.291 / 26.320 / 26.321 / 26.331 / 26.361 / 26.365 / 27.365 / 30.240 / 30.281 / 30.291 / 30.320 / 30.321 / 30.331 / 30.361 / 32.240 / 32.281 / 32.291 / 32.320 / 32.321 / 32.331 / 32.361 / 32.365 / 38.320 / 40.365 / 40.440	1513.80	 1378
48.321	1513.80	 1435
520 HK	1378.80	 1476
MASSEY FERGUSON		
MF 35 / TO 35 / MF 36 / MF 50 / MH 50 / MF 65 / MF 80 / MF 135 / MF 150 / MF 165 / MF 175 / MF 202 / MF 203 / MF 204 / MF 205 / MF 410 / MF 510 (avec Moteur GMC) / 135 G / 150 G / 165 G / 175 G / 185 G	1378.80	 1513
MF 303	1435.80	 3296
MF 510 (Moteur Perkins)	1309.82	
MERCEDES BENZ		
OM 314 / OM 327 / OM 352 / OM 352 A / OM 355 / OM 355 A / OM 360 III / OM 362 / OM 364 / OM 366 / OM 366 A / OM 366 LA / OM 621 nouveau	1513.83	
OM 615	1476.79	
OM 615 / OM 616 / OM 617	3296.80	
M 121/68 / M 121/80 / M 121 / M 123 / M 130 / M 180 / M 115	1476.79	
M 110 / M 115 / M115 KV 23	1476.87	
OM 401 / OM 402 / OM 403 / OM 404 / OM 404 A/OM 407/OM 409/ OM 421 / OM 422 / OM 422 LA / OM 423 / OM 424 / OM 424 A / OM 442 / OM 442 A / OM 442 LA / OM 443 / OM 444 A / LA	1513.83	
OM 423 LA	1513.71 x 2 1513.83 x 2	
Type		
O 302	1513.71	
L 206 D / L 207 D / L 306 D / L 307 D / L 309 D / L 406 D / L 407 D / L 409 D / O 309 D / avec OM 615 / OM 616 / OM 617 L 406 D avec OM 32113.89 L 206 / L 207 / L 307 avec moteur essence A 7090.77 O 303 / O 30713.71 710 / 911 / 1113 / 1413 / O 302 / O 321 / O 321 H / O 321 HL / 13.83 O 322 / O 322 H	3296.80	
Tous Moteurs 208 / 210 / 308 / 310 / 410	1476.87	
L 408 / L 409	1476.79	
L 408 / L 409 / L 410	1476.87	
405 / 406 / 407 / 408 D / 508 D / 608 / 608 D / 613 D / LP 613 / 709 / 710 / 808 / 809 / 810 / 811 / 813 / 814 / 911 / 912 / 913 / 1013 / 1017 / 1113 / 1114 / 1120 / 1213 / 1217 / 1219 / 1222 / 1313 / 1317 / 1319 / 1413 / 1417 / 1419 / 1422 / 1424 / 1425	1513.83	
1513 / 1517 / 1519 / 1613 / 1614 / 1617 / 1619 / 1621 / 1622 / 1624 / 1625 / 1626 / 1628 / 1632 / 1633 / 1635 / 1636 / 1638 / 1644 / 1719 / 1813 / 1819 / 1919 / 1923 / 1924 / 1926 / 1928 / 1932 / 1933 / 1936 / 1938 / 2024 / 2026 / 2028 / 2032 / 2033	1513.83	
2036 / 2219 / 2222 / 2224 / 2226 / 2228 / 2232 / 2233 / 2236 / 2238 /13.83 2624 / 2626 / 2628 / 2632 / 2633 / 2636 / 2638 / 3328 / 3333 / 3336 / 3535	1476.87	







VEHICULE MODEL FAHRZEUGTYP	VERNET	PHOTOS PICTURES ZEICHUNGEN
3850	1513.71 x 2 1513.83 x 2	 1290
○ 302 / ○ 303 / ○ 305 / ○ 307 / ○ 309 / ○ 309 B / ○ 309 D / ○ 317 / ○ 317 K / ○ 319 / ○ 319 B / ○ 319 D / ○ 320 / ○ 321 / ○ 322 / LF 8 / LF 16 / LF / LAF 113 / LF 408 / LF / LFH 710 / TLF 16 TRO / TLF 16 RW 1-3	1513.83	 1309
319 B / 319 D	1513.83	 1378
LB 608 / LB 1313	1513.71	 1400
LB 608 / LB 1313	1513.83	 1476
U 40/421 / U 54/403 / U 66/403 / U 70/406 / U 80/413 / U 80/416 / U 84/406 / U 90/416 / U 90/416T / U 100 / U 100/416 / U 110/416	1513.83	 1513
U 110/416 / U 110/416 T / U 120/425 / U 125/416 / U 150/425 / S 82	1513.83	 3296
U 404.0	1513.83	 5239
U 600 / U 600 L / U 600 T	3296.80	 CT16958
U 52/421 / U 60/421 T	1476.79	
U 52/421 / U 60/421 T	3296.80	
U 800 / U 800 L / U 900 / U 1000 / U 1100 / U 1100 L / U 1100 T / U 1300 / U 1300 L / U 1400 / U 1500 / U 1500 T / U 1600 / U 1700 / U 1700 T / U 2100 / MB-trac 800 / 1100 / 1300	1513.83	
PEGASO		
10,5 l Moteur diesel série 95. T1, 1080 L, 1080 / 50 / 51 / 52 / 60 / 61, 1086/50, 2080/50 / 60	5239.75	
12 l Moteur diesel Série 96, T1 et Série 9151	CT16958.76	
PERKINS		
V8 / 51090.73 /	1290.82	
P3 / 3 A - 152 D / P4 / L4 / 4 A - 270 / 4 A - 270 D / P 6 / 6 - 305 / 6 - 340 / L 4 - Massey-Ferguson 780 Combiné / 4 A, 270 - Massey-Ferguson 780 Combiné / Massey-Ferguson F.E. 35	1290.82	
3.144 / A 3.144 / 3.152 / A 3.152 / D 3.152 / AD 3.152 / 4.99 / A 4.99 / 4.107 / A 4.107 / 4.108 / 4.192 / 4.203 / A 4.212 / 4.270 / 6 PF 288 / 6 PF 305 / DZ 101 / A 4.236 / A 4.248 / T 8.510	1378.83	
T 6.354.3	1400.83	
6.354 (IHC)	1309.82	
SCANIA		
LB 80 / L 81 / LB 81 / LB 85 / LBS 85 / L 86 / LB 86 / LBS 86 / LS 86 / BR 85 / CR 85 / B 86 / BF 86 / BR 86 / K 82 / LD 81 / LOS 86 / Moteurs D 11 / DS 11 / DS 14	1513.80	
B111 / BF 111 jusqu'à Châssis N. 1.871.350 / LB 111 / LBS 111 / LBT 111, jusqu'à Moteur N. 5.208.646	1513.80	
K 112 / BR 116 / L 140 / LS 140 / LB 140 / LBS 140 / LBT 140 / LT 145	1513.83	
LB 140 / LBS 140 / LBT 14013.80 / 1513.83		
L 141 / LS 141 / LB 141 / LBS 141 / LBT 141 / LT 146 / LBS 141 / LBT 141 / LT 146	1535.80	
VOLVO		
F 4, F 408 / F 609 / F 610 / F 611 / F 612 / F 614 / F 616 / Moteur TD 40 /15.76 / TD 60 B / TD 60 P / TD 6010	1515.81	



LISTE D'APPLICATIONS

APPLICATION LIST/ANWENDUNGSLISTE

VEHICULE MODEL FAHRZEUGTYP	VERNET	PHOTOS PICTURES ZEICHUNGEN
F 6, Moteur D 60, F 6 S, Moteur TD 60	1515.76 x 2	 1514  1515
B 54 / F 84 / N 84 / F 85, Moteur D 50 A, B / TD 50 A, B14.76 x 2 / B 57 / F 86 / N 86, Moteur D 70, TD 70 / D 70 A / TD 70 E / TD 70 F	1514.66 15.76 x 2 1515.81 x 2	
C 303 / C 304 / C 306	4856.88	 4856  CT16957
N 7 4 x 2	1515.76 1515.81	
N 7 Moteur TD 70	1515.76 x 2	 CT18201
F 7 / N 7 Moteur TD 70 G	1515.81 x 2	
N 10 / F 88 / G 88 / N 88, Moteur D 100 A, B / TD 100 A	1515.76 1515.81 x 2	
F 12 / N 12 / F 89 / G 89, Moteur TD 120 A	1515.76 1515.81	
F 12 / N 12 / F 89 / G 89, Moteur TD 120 C, D, E, F, G	1515.81 x 3	
FB 88, NB 88 Moteur D 100 A, B, TD 100 A	1515.76 1515.81	
B 10 M / B 10 R / B 58, Moteur THD 100 A, D	1515.76 x 3	
F 12, Moteur TD 121 G, F / TD 122 / FLG / F 7 / N 7 - Moteur TD 70 G	CT16957.82	
New type	CT18201.76	



THERMOSTATS
THERMOSTATS / THERMOSTATE

LISTE NUMÉRIQUE AVEC PHOTOS

NUMERICAL LIST WITH PICTURES

AUFLISTUNG MIT ZEICHUNGEN

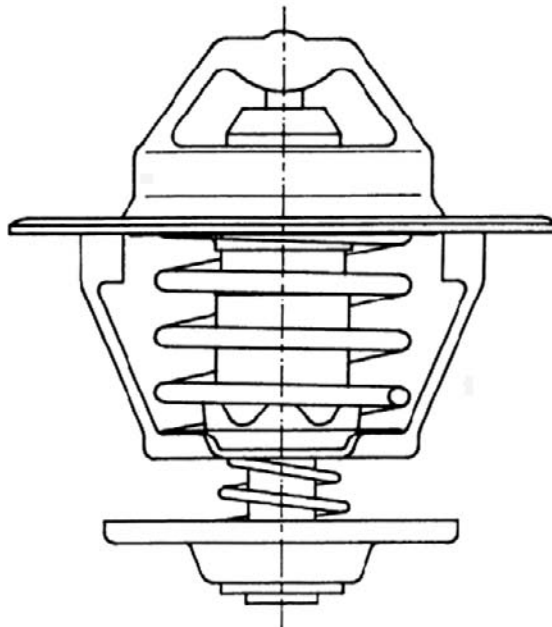

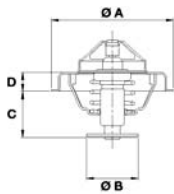

LISTE NUMÉRIQUE

NUMERICAL LIST/AUFLISTUNG

245F

FIAT
LANCIA
SEAT



0963

CITROEN
FIAT
PEUGEOT

A: 43,5
C: 23



1183

FORD
PEUGEOT
RENAULT
TALBOT
VOLVO

A: 68
B: 47,6
C: 26
D: 10,5



Jiggle pin

1248

DAIHATSU
SUBARU

A: 43,5
C: 23



With leak groove

1275

CITROEN

A: 43,5
C: 23



With leak groove / Locating lug

1290

FORD
HYUNDAI
NISSAN
OPEL
ROVER

SAAB

A: 54
C: 22,5



Jiggle pin

1335

FORD
OPEL
TALBOT

A: 54
B: 35
C: 29,5



1343

VOLVO

A: 48
C: 20,5
D: 2,5



With leak groove

1378

JEEP
NISSAN
OPEL
ROVER

A: 54
C: 22,5



With leak groove



LISTE NUMÉRIQUE

NUMERICAL LIST/AUFLISTUNG

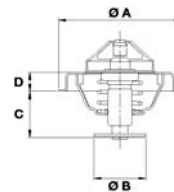

1392

YUGO - ZASTAVA

A: 55,9
B: 35
C: 32,5



With leak groove

1400

AUDI
FIAT
PORSHE
RENAULT
VOLKSWAGEN

A: 54
B: 35
C: 32,5



Jiggle pin

1410

AUDI
FORD
VOLKSWAGEN

A: 48
C: 20,5
D: 2,5



With leak groove

1413

PEUGEOT

A: 55,5
B: 52,6
C: 21,7



With leak hole

1414

PEUGEOT

A: 55,5
B: 52,6
C: 21,7
D: 22,5



With leak groove

1415

PEUGEOT

A: 53,5
C: 22,5



With leak groove

1416

HONDA
MAZDA
MITSUBISHI
SUZUKI
TOYOTA

A: 51,9
C: 22,5



With leak groove

1417

RENAULT
VOLVO

A: 53,5
C: 22,5



1418

PEUGEOT
TALBOT

A: 54
B: 29
C: 30



With leak groove / Locating lug

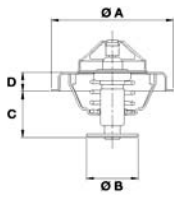

1419

FORD
LAND ROVER
MAZDA
NISSAN
ROVER

A: 54
B: 29
C: 33,5



Jiggle pin

1420

VOLVO

A: 54
B: 20
C: 31,7



Jiggle pin

1427

LAND ROVER
PEUGEOT
ROVER

A: 48
B: 44,5
C: 21,7



1435

PORSCHE

A: 67
B: 43
C: 26
D: 7,5



With leak groove

1439

AUDI
OPEL
PORSCHE
SEAT
VOLKSWAGEN

A: 54
B: 35
C: 31



1468

PEUGEOT



With leak groove

1473

FIAT
SEAT
YUGO - ZASTAVA

A: 54
C: 19
D: 4,3



With leak groove

1476

MERCEDES

A: 67
B: 43
C: 26
D: 7,5



Jiggle pin

1477

CHRYSLER

A: 51,9
C: 22,5



Jiggle pin



LISTE NUMÉRIQUE

NUMERICAL LIST/AUFLISTUNG

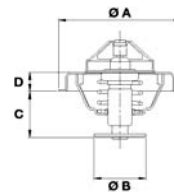

1503

PEUGEOT
RENAULT
TALBOT

A: 55,5
B: 52,6
C: 21,7



1508

ALFA ROMEO

A: 54
B: 29
C: 25



With leak groove

1513

MERCEDES

A: 67
B: 43
C: 25,5
D: 7,5



1514

ALFA ROMEO
FIAT
JAGUAR
LANCIA
SAAB

VOLVO

A: 54
B: 29
C: 31,7



Jiggle pin / Flow limiting valve

1519

AUTOBIANCHI
FIAT
FSO-POLSKI
INNOCENTI

A: 56
B: 32
C: 35
D: 4,3



With leak groove

1522

AUTOBIANCHI
FIAT
SEAT
YUGO - ZASTAVA

C: 21,5



1528

BMW

A: 67
B: 29
C: 35
D: 2,5



1529

CITROEN
PEUGEOT
TALBOT

A: 54
B: 29
C: 30



1533

JEEP
RENAULT

A: 68
B: 47,6
C: 26
D: 10,5



With leak groove

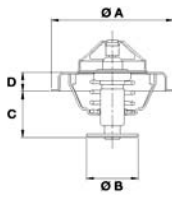

1535

AUDI
BMW
FORD
JEEP
MERCEDES

VOLVO

A: 67
B: 35
C: 25,5
D: 7,5



1538

CITROEN
FIAT
LANCIA
NISSAN
PEUGEOT

A: 53,5
B: 29
C: 35,2



Flow limiting valve

1542

CITROEN
LADA
NISSAN
PEUGEOT
ROVER

A: 45,5
B: 29
C: 35,2



Flow limiting valve

1547

JEEP
RENAULT

A: 68
B: 29
C: 26
D: 10,5



2150

PEUGEOT



2620

CITROEN
FIAT
PEUGEOT

A: 57
C: 22,5



Jiggle pin / Locating lug

3309

FIAT
LANCIA

A: 54
B: 29
C: 25



Jiggle pin / Insert on valve

3310

BMW



3311

FIAT
SEAT





LISTE NUMÉRIQUE

NUMERICAL LIST/AUFLISTUNG

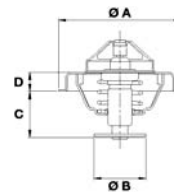

3319

FORD

A: 48
C: 21
D: 2,5



Jiggle pin

3327

PEUGEOT

A: 68
B: 29
C: 26
D: 10,5



With leak hole

3328

CHEVROLET - DAEWOO
DAIHATSU
HYUNDAI
INNOCENTI
NISSAN

SUBARU
SUZUKI

A: 44
C: 23



Jiggle pin / Off-set valve seat

3334

SAAB

A: 54
B: 29
C: 33,5



Jiggle pin / Flow limiting valve

3335

RENAULT

A: 68
B: 41
C: 26
D: 10,5



With leak groove

3339

SAAB

A: 54
C: 22,5



Jiggle pin / Flow limiting valve

3349

AUDI
SEAT
SKODA
VOLKSWAGEN

A: 54
B: 35
C: 31



Rubber valve

3357

NISSAN

A: 48
B: 29
C: 32,5
D: 2,5



Jiggle pin

3359

LADA



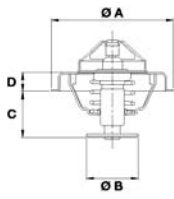

LISTE NUMÉRIQUE

NUMERICAL LIST/AUFLISTUNG

3720

LADA



3905

FIAT
YUGO - ZASTAVA



4046

CITROEN

A: 54
C: 22,5



With leak groove / Flow limiting valve

4168

RENAULT
VOLVO

A: 53,5
C: 22,5



Jiggle pin

4324

RENAULT

A: 43,5
B: 40,5
C: 44
D: 25



4493

RENAULT

A: 43,5
B: 40,5
C: 37
D: 25



4495

DACIA
RENAULT
VOLVO

A: 43,5
B: 40,5
C: 37
D: 25



With leak groove

4561

VOLVO

A: 54
B: 35
C: 30,5



Jiggle pin

4608

SKODA

A: 60
C: 22,5



Jiggle pin



LISTE NUMÉRIQUE

NUMERICAL LIST/AUFLISTUNG

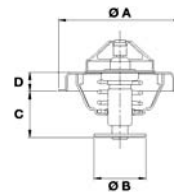

4640
CITROEN
PEUGEOT
A: 68
C: 16
D: 7,5



Rubber valve

4780
CITROEN
PEUGEOT
A: 68
B: 29
C: 26
D: 10,5



Jiggle pin / Rubber valve

4856
VOLVO
A: 54
B: 29
C: 13
D: 18



Jiggle pin

4885
CITROEN
FIAT
LANCIA
PEUGEOT
A: 55
C: 22,5



Rubber valve

4898
CHEVROLET - DAEWOO
OPEL
A: 48
C: 22,5



Jiggle pin / Rubber valve

4945
CITROEN
PEUGEOT
A: 68
B: 29
C: 26
D: 10,5



Rubber valve

4947
CITROEN
FORD
JEEP
PEUGEOT
RENAULT
TALBOT
A: 68
B: 29
C: 26
D: 10,5



Rubber valve

4949
PEUGEOT
A: 68
C: 13
D: 10,5



Rubber valve

5069
AUTOBIANCHI
FIAT
LANCIA
C: 15



Jiggle pin / Rubber valve

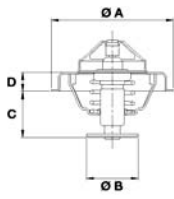

LISTE NUMÉRIQUE

NUMERICAL LIST/AUFLISTUNG

5070

FIAT



Rubber valve

5071

FIAT
INNOCENTI
LANCIA



Rubber valve

5074

FIAT
LANCIA
SEAT



5075

DAIHATSU
HONDA
HYUNDAI
KIA
MAZDA

MITSUBISHI
PROTON
SUZUKI

A: 51,9
C: 19

HONDA
MAZDA



Jiggle pin / Off-set valve seat

5076

A: 52
C: 26



Jiggle pin / Rubber valve

5077

DAIHATSU
FORD

A: 52
B: 28
C: 34



Jiggle pin

5079

NISSAN

A: 48
B: 28
C: 33



Jiggle pin inverted / Off-set valve seat / Rubber valve

5083

RENAULT
VOLVO

A: 67
B: 29
C: 25,5
D: 10,5



Rubber valve

5108

CITROEN
FIAT
LANCIA
PEUGEOT
TALBOT

VOLVO

A: 53,5
C: 22,5



Rubber valve



LISTE NUMÉRIQUE

NUMERICAL LIST/AUFLISTUNG

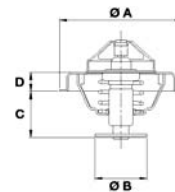

5111

BMW

A: 67
B: 35
C: 25,5
D: 7,5



5130

CITROEN
FIAT
FSO-POLSKI
HYUNDAI
LADA

LANCIA
PEUGEOT
SUZUKI
TOYOTA

A: 55
B: 29
C: 35,5



Rubber valve

5151

SEAT
VOLKSWAGEN

A: 54
B: 35
C: 31



Rubber valve

5229

PEUGEOT

A: 68
C: 13
D: 10,5



Rubber valve

5231

CITROEN
PEUGEOT
ROVER

A: 68
B: 29
C: 26
D: 10,5



Rubber valve

5284

DACIA
RENAULT

A: 50
B: 40
C: 39
D: 24,5



Rubber valve

5309

CITROEN
PEUGEOT



Rubber valve

5313

CITROEN
PEUGEOT



Rubber valve

5353

RENAULT

A: 55
B: 29
C: 35,5



Rubber valve

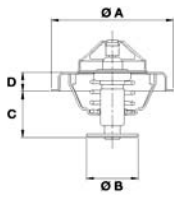

LISTE NUMÉRIQUE

NUMERICAL LIST/AUFLISTUNG

5413

CITROEN
PEUGEOT



5434

MITSUBISHI
VOLVO

A: 56
B: 29
C: 43



5446

RENAULT

A: 55
B: 29
C: 35,5



Jiggle pin inverted / Rubber valve

Rubber valve

5493

RENAULT

C: 26



5504

FSO-POLSKI
ROVER

A: 54
C: 22,5



5686

FIAT



Jiggle pin

5687

FIAT
INNOCENTI
LANCIA
PEUGEOT



5688

ALFA ROMEO
FIAT
LANCIA



5699

MERCEDES
SSANGYONG

A: 66,6
B: 42
C: 30,5
D: 8,1



Rubber valve

Rubber valve

Jiggle pin inverted / Locating lug



LISTE NUMÉRIQUE

NUMERICAL LIST/AUFLISTUNG

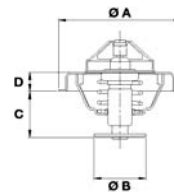

5700

FIAT
LANCIA
RENAULT

A: 54
C: 22,5



Jiggle pin / Rubber valve

5750

FORD
MAZDA

A: 51,8
B: 35
C: 33,8



Jiggle pin

5753

JAGUAR

A: 67
B: 35
C: 26
D: 10,5



Jiggle pin inverted

5757

VOLVO

A: 67
B: 29
C: 25,5
D: 10,5



Rubber valve

5792

MITSUBISHI
NISSAN

A: 54
B: 29
C: 33,5



With leak groove

5812

JEEP

A: 54
C: 22,5



5898

OPEL
RENAULT

A: 54
B: 29
C: 25



Jiggle pin

5902

AUDI
SKODA
VOLKSWAGEN

A: 67
B: 35
C: 25,5
D: 7,5



Jiggle pin inverted

5952

ROVER

A: 51,9
B: 29
C: 33



With leak groove

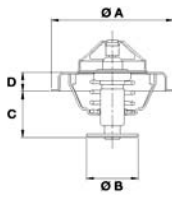

5953

ALFA ROMEO

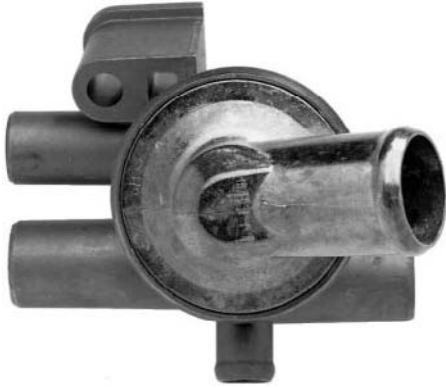

5955

LAND ROVER
ROVER

A: 51,9
C: 22,5



5962

AUDI
OPEL
ROVER
SEAT
SKODA

VOLKSWAGEN

A: 54
C: 22,5



5963

CHRYSLER
FORD
JEEP
LAND ROVER
MERCEDES

OPEL
ROVER

A: 67
B: 43
C: 25,5
D: 7,5



5964

ALFA ROMEO



5966

ALFA ROMEO
FIAT

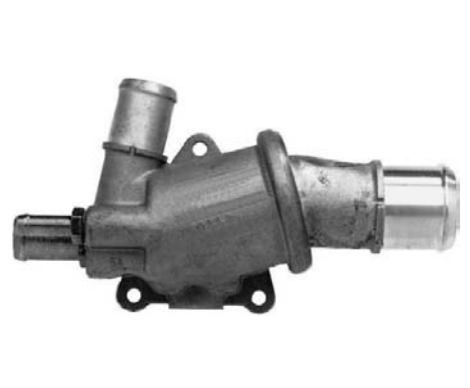

Jiggle pin

5967

ALFA ROMEO

5968

AUDI
VOLKSWAGEN
VOLVO

A: 67
B: 35
C: 25,5
D: 7,5



5971

MAZDA
NISSAN
OPEL
SSANGYONG
SUBARU

A: 54
C: 19



Rubber valve

Jiggle pin / Off-set valve seat



LISTE NUMÉRIQUE

NUMERICAL LIST/AUFLISTUNG

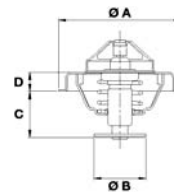

5973

BMW
FORD
LAND ROVER
OPEL
SEAT

VOLKSWAGEN

A: 67
B: 29
C: 25,5
D: 7,5



Jiggle pin inverted / Rubber valve

5975

ALFA ROMEO
FIAT
LANCIA



Jiggle pin inverted

5976

FIAT



Jiggle pin inverted

5977

FORD

A: 51,9
C: 22,5



Jiggle pin

5978

FORD

A: 53,5
B: 29
C: 33,5



Rubber valve

5979

OPEL

B: 29
C: 30



Rubber valve

5980

KIA
MAZDA
OPEL
SUZUKI

A: 54
C: 22,5



Jiggle pin / Off-set valve seat

5981

SAAB

A: 54
B: 29
C: 34



Jiggle pin

6007

FORD

A: 54
B: 29
C: 34,5



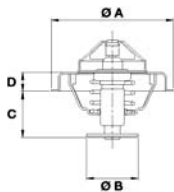

6045

OPEL
 RENAULT
 VOLVO

A: 53,5
C: 23



Rubber valve

6047

DACIA
 OPEL
 RENAULT

A: 50
C: 23



Rubber valve

6063

SAAB

A: 54
B: 29
C: 34



Jiggle pin

6070

FIAT
 SEAT



Rubber valve

6073

FIAT



Rubber valve

6106

CITROEN
 PEUGEOT

C: 35



6126

NISSAN
 RENAULT



6148

CITROEN
 PEUGEOT

A: 53,5
C: 22,5



6171

OPEL

B: 29
C: 30





LISTE NUMÉRIQUE

NUMERICAL LIST/AUFLISTUNG

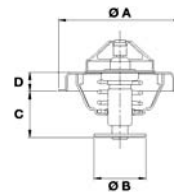

6191

CITROEN
PEUGEOT

C: 35



6222

CHEVROLET - DAEWOO
OPEL



6231

FORD

A: 38
C: 22



6237

OPEL



6242

BMW

A: 66,5
B: 43
C: 32
D: 8



6243

BMW

A: 67
B: 35
C: 28
D: 7,5



Leak Hole on Bypass

6244

FORD
JEEP
MAZDA

A: 54
C: 23



Jiggle pin

6245

FORD

A: 48
B: 0
C: 29



Jiggle pin

6246

JAGUAR

A: 67
B: 35
C: 25,5
D: 7,5



Jiggle pin

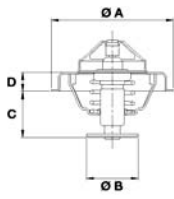

LISTE NUMÉRIQUE

NUMERICAL LIST/AUFLISTUNG

6247

MERCEDES

B: 43
C: 33



6248

FORD
OPEL

A: 54
B: 35
C: 30



6249

OPEL
SAAB

B: 30
C: 21



6250

FIAT
LANCIA

C: 15



6251

OPEL



6252

HONDA
HYUNDAI
MAZDA
OPEL

A: 54
B: 22
C: 33



Jiggle pin / Rubber valve

Jiggle pin / Rubber valve

6253

LANCIA



6254

ALFA ROMEO
FIAT
LANCIA



Rubber valve

6255

ALFA ROMEO
FIAT
LANCIA





LISTE NUMÉRIQUE

NUMERICAL LIST/AUFLISTUNG

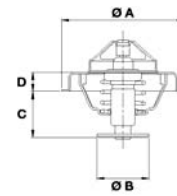

6256

FIAT



6258

FIAT



6259

FIAT



6261

FIAT



6262

FIAT



6263

FIAT
LANCIA



Rubber valve

6264

FIAT



6265

FIAT



6266

FIAT



Rubber valve

Jiggle pin

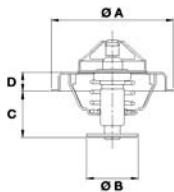

6267

DAIHATSU
HONDA
ROVER

A: 52
B: 28
C: 33,5



Jiggle pin inverted / Off-set valve seat

6273

AUDI
FORD
SEAT
SKODA
VOLKSWAGEN

A: 54
B: 35
C: 31



Rubber valve

6274

AUDI
SEAT
SKODA
VOLKSWAGEN



6275

DAIHATSU

A: 52
B: 28
C: 35



Jiggle pin inverted / Rubber valve

6276

AUDI
MITSUBISHI
SEAT
SKODA
VOLKSWAGEN

A: 54
C: 23



6284

BMW

B: 39
C: 33



Jiggle pin inverted

6285

MERCEDES
VOLKSWAGEN

B: 43
C: 33



Jiggle pin

6286

OPEL

B: 30
C: 0



Rubber valve

6287

OPEL

B: 29
C: 30





LISTE NUMÉRIQUE

NUMERICAL LIST/AUFLISTUNG

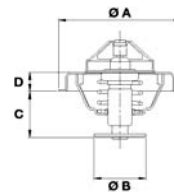

6292

KIA
MAZDA

A: 52
C: 22,5



Jiggle pin / Off-set valve seat

6293

HYUNDAI

A: 53,5
B: 35
C: 34,5



Jiggle pin / Rubber valve

6294

HYUNDAI
KIA

A: 53,5
B: 29
C: 33



Jiggle pin inverted / Rubber valve

6295

LEXUS
MITSUBISHI
NISSAN
PROTON
TOYOTA

A: 56
B: 28
C: 43,5



Jiggle pin inverted / Rubber valve

6296

HONDA

A: 52
B: 29
C: 35



Jiggle pin inverted

6297

CHRYSLER
HONDA
HYUNDAI
KIA
NISSAN

OPEL

A: 64
B: 30
C: 43



Jiggle pin inverted / Rubber valve

6310

DAIHATSU
TOYOTA
VOLKSWAGEN

A: 51,9
C: 23



Jiggle pin / Rubber valve

6311

TOYOTA

A: 56
B: 29
C: 35



Jiggle pin inverted / Rubber valve

6312

JAGUAR
TOYOTA
VOLKSWAGEN

A: 51,9
B: 30
C: 33



Jiggle pin / Rubber valve

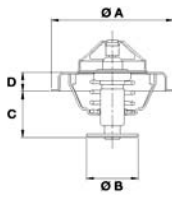

6313

NISSAN

A: 54
C: 22,5



Jiggle pin

6314

FORD
NISSAN

A: 54,5
B: 28
C: 31,5



Jiggle pin inverted / Rubber valve

6318

MITSUBISHI
VOLVO

A: 53,5
C: 23



Jiggle pin

6319

FORD
HYUNDAI
KIA
MAZDA
NISSAN

A: 53,5
B: 29
C: 33



Jiggle pin / Rubber valve

6320

OPEL
RENAULT



6434

SEAT
VOLKSWAGEN

A: 54
B: 35
C: 31



Rubber valve

6332

CITROEN
FIAT
LANCIA
PEUGEOT

B: 29
C: 43



Rubber valve

6393 **NEW**

RENAULT



Rubber valve

6454

NISSAN
OPEL
RENAULT



Rubber valve



LISTE NUMÉRIQUE

NUMERICAL LIST/AUFLISTUNG

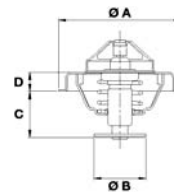

6463

ALFA ROMEO

B: 27
C: 27



With leak groove

6484

DAIHATSU
HYUNDAI
KIA
TOYOTA
VOLKSWAGEN

A: 48
B: 28
C: 33



Jiggle pin inversed / Rubber valve

6488

CITROEN
FIAT
PEUGEOT

C: 35



6489

ALFA ROMEO
FIAT
LANCIA



6490

ALFA ROMEO
FIAT
LANCIA



6492

BMW

B: 35
C: 26



Jiggle pin inversed / Rubber valve

6493

BMW
LAND ROVER

B: 43
C: 39



Jiggle pin inversed

6494

BMW

B: 33
C: 31



Jiggle pin inversed

6495

BMW

B: 43
C: 33



Jiggle pin inversed

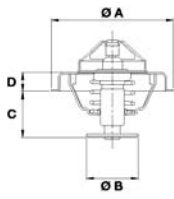

LISTE NUMÉRIQUE

NUMERICAL LIST/AUFLISTUNG

6496

BMW

B: 43
C: 39



Jiggle pin inversed

6497

BMW

A: 83
B: 43
C: 34
D: 7



Jiggle pin inversed

6498

BMW

B: 39
C: 33



Jiggle pin inversed

6499

BMW

B: 43
C: 38



6501

CHEVROLET - DAEWOO
OPEL

B: 29
C: 30



6502

CHEVROLET - DAEWOO



6504

FIAT
LANCIA



6506

ALFA ROMEO
FIAT
LANCIA



6508

FIAT



Leak Hole on Bypass



LISTE NUMÉRIQUE

NUMERICAL LIST/AUFLISTUNG

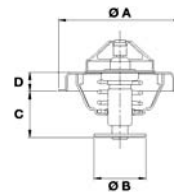

6509

FIAT
LANCIA



6510

LAND ROVER

A: 54
C: 23



Jiggle pin

6511

LAND ROVER

A: 52
B: 33
C: 40



Jiggle pin / Rubber valve

6513

MERCEDES

B: 43
C: 34



With leak groove

6514

MERCEDES



6516

OPEL

B: 30
C: 10



6517

OPEL



6518

OPEL

B: 30
C: 10



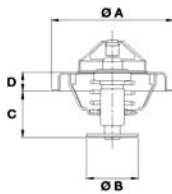

6519

OPEL

B: 30
C: 30



Jiggle pin

6520

TOYOTA

A: 60
B: 30
C: 41



Jiggle pin inverted / Rubber valve

6523

VOLKSWAGEN

A: 67
B: 33
C: 23
D: 7,5



Rubber valve

6524

VOLKSWAGEN

A: 54
B: 29
C: 34



Jiggle pin / Rubber valve

6525

DAIHATSU
TOYOTA

A: 73
B: 31
C: 37
D: 11



Jiggle pin / Rubber valve

6526

FORD
MAZDA

A: 51,9
B: 35
C: 33,5



6529

AUDI
VOLKSWAGEN

A: 67
B: 35
C: 25
D: 8



Jiggle pin inverted

6533

AUDI
SEAT
SKODA
VOLKSWAGEN

A: 67
B: 35
C: 25
D: 8



Jiggle pin inverted / Rubber valve

6536

FIAT



Jiggle pin inverted



LISTE NUMÉRIQUE

NUMERICAL LIST/AUFLISTUNG

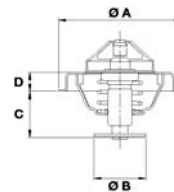

6537

ALFA ROMEO
FIAT
LANCIA



Jiggle pin inversed

6538

FIAT

A: 0



Jiggle pin inversed

6539

FIAT



Jiggle pin inversed

6541

CITROEN
FIAT
INNOCENTI
LANCIA
PEUGEOT

C: 23



Jiggle pin

6543

MERCEDES

A: 67
B: 29
C: 44
D: 7,5



Jiggle pin inversed

6544

MERCEDES

A: 67
B: 43
C: 25,5
D: 7,5



Jiggle pin inversed

6547

FIAT
LANCIA



Leak Hole on Bypass

6550

FIAT



Rubber valve

6551

ALFA ROMEO
FIAT
LANCIA



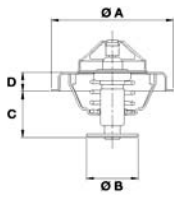

6553

FIAT



Jiggle pin inversed

6554

FIAT



Jiggle pin inversed

6555

FIAT



6556

FIAT



Jiggle pin inversed

6557

FIAT
LANCIA



6559

LANCIA



6560

FIAT



6561

FIAT



6562

FIAT





LISTE NUMÉRIQUE

NUMERICAL LIST/AUFLISTUNG

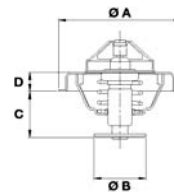

6564

AUTOBIANCHI
FIAT
LANCIA



6565

FIAT

C: 13

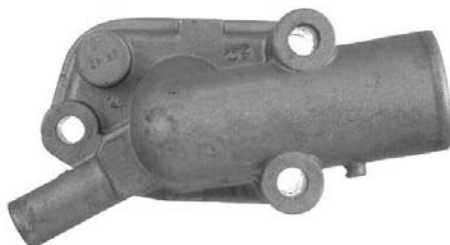

6568

ALFA ROMEO



Jiggle pin / Rubber valve

6570

ALFA ROMEO
CHRYSLER



Jiggle pin inversed

6571

ALFA ROMEO

B: 27
C: 28

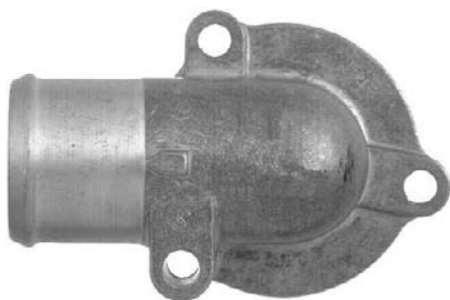

6574

ALFA ROMEO



6575

ALFA ROMEO



6576

ALFA ROMEO
LANCIA



6577

MITSUBISHI

A: 52
B: 28
C: 34



Jiggle pin / Off-set valve seat / Rubber valve

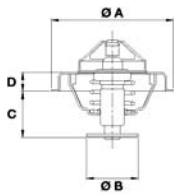

6578

FORD
JAGUAR

A: 54
B: 35
C: 40



Jiggle pin inverted

6580

HYUNDAI
KIA

A: 54
B: 33
C: 33



Jiggle pin / Rubber valve

6581

CITROEN
FIAT
OPEL
PEUGEOT

A: 54
B: 25
C: 27



Jiggle pin / Rubber valve

6583

HONDA
LEXUS
MITSUBISHI
NISSAN
SAAB

TOYOTA

A: 64
B: 30
C: 41



Jiggle pin inverted / Rubber valve

6585

TOYOTA

A: 52
B: 28
C: 33



Jiggle pin inverted / Rubber valve

6587

MINI
TOYOTA

A: 56
B: 28
C: 34



Jiggle pin inverted / Rubber valve

6590

FIAT
LANCIA



6592

FIAT



6593

FSO-POLSKI

A: 56
B: 30
C: 34
D: 4,3



With leak groove



LISTE NUMÉRIQUE

NUMERICAL LIST/AUFLISTUNG

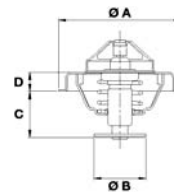

6595

LADA



6596

LADA



6597

LADA



6598

FIAT
YUGO - ZASTAVA

C: 23



6599

HONDA
ROVER

A: 52
B: 28
C: 34



6603

LADA



Jiggle pin / Rubber valve

Jiggle pin inversed / Off-set valve seat / Rubber valve

6628

RENAULT
SUZUKI



6666

DACIA
NISSAN
RENAULT
SUZUKI



6702

FORD
MAZDA
SUZUKI

A: 52
B: 28
C: 40



Rubber valve

Rubber valve

Jiggle pin inversed / Rubber valve

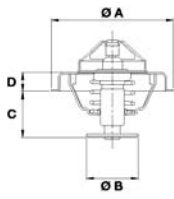

6703 NEW

NISSAN
RENAULT



Rubber valve

6708

FIAT



6722

FIAT



Jiggle pin inverted

6731

FIAT



6732

SKODA



6733

SKODA



6736

SUBARU

A: 56
C: 34



Jiggle pin inverted / Off-set valve seat / Rubber valve

6737

SUZUKI

A: 52
C: 28



Jiggle pin inverted / Rubber valve

6756

CITROEN
FORD
PEUGEOT
VOLVO





LISTE NUMÉRIQUE

NUMERICAL LIST/AUFLISTUNG

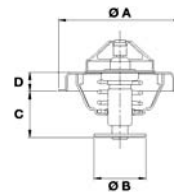

6779

LADA

A: 63
B: 43
C: 42



Jiggle pin

6780

LADA

A: 31
B: 20
C: 38,5



6782

FIAT
LANCIA



6808 **NEW**

CITROEN
PEUGEOT



6823

ALFA ROMEO



6824

ALFA ROMEO



Leak Hole on Bypass

6825

ALFA ROMEO
LANCIA



6826

ALFA ROMEO
FIAT
LANCIA



6827

ALFA ROMEO



Leak Hole on Bypass

Leak Hole on Bypass

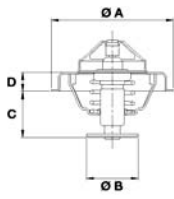

6828

DAIHATSU

A: 44
B: 23
C: 39



Jiggle pin

6831

FIAT



Jiggle pin inversed

6832

FIAT



Leak Hole on Bypass

6833

FIAT



Leak Hole on Bypass

6834

FIAT
LANCIA



Leak Hole on Bypass

6835

FIAT
LANCIA
OPEL
SUZUKI



Leak Hole on Bypass / Rubber valve

6836

FIAT



Leak Hole on Bypass

6837

FORD
VOLVO

A: 48
C: 26,5



Jiggle pin inversed / Off-set valve seat / Rubber valve

6838

FORD

A: 54
B: 35
C: 40



Jiggle pin inversed



LISTE NUMÉRIQUE

NUMERICAL LIST/AUFLISTUNG

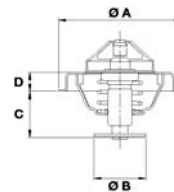

6839

FIAT
LANCIA



Leak Hole on Bypass

6840

HYUNDAI

A: 56
B: 28
C: 43,5



Rubber valve

6842

AUDI
VOLKSWAGEN



6843

CHRYSLER
JEEP
MINI

A: 46
B: 0
C: 24



Jiggle pin / Locating lug

6844

MAZDA

A: 48
C: 28



Jiggle pin inversed / Rubber valve

6845

CHRYSLER
JEEP

A: 54
C: 27



Jiggle pin inversed / Rubber valve

6846

MERCEDES



Jiggle pin

6847

JEEP
MERCEDES



Jiggle pin

6848

MERCEDES



Jiggle pin

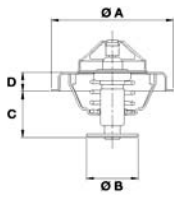

6849

MERCEDES

B: 29
C: 45



Jiggle pin inversed

6850

MERCEDES



Jiggle pin

6851

NISSAN

A: 64
B: 23,5
C: 49



Jiggle pin inversed / Rubber valve

6853

OPEL

B: 30
C: 10



6856

OPEL

B: 30
C: 30



6854

OPEL

B: 30
C: 10



6857

OPEL
SAAB

B: 30
C: 10



6855

OPEL

B: 30
C: 10



6858

OPEL

A: 54
B: 22
C: 33



Rubber valve



LISTE NUMÉRIQUE

NUMERICAL LIST/AUFLISTUNG

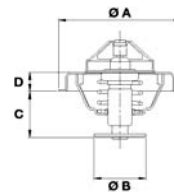

6859

SKODA



6860

NISSAN
RENAULT

B: 30
C: 28



Jiggle pin inversed

6861

RENAULT

B: 30
C: 28



6862

PORSCHE

A: 40
B: 35
C: 42



6864

AUDI
SEAT
VOLKSWAGEN



6865

VOLVO



Jiggle pin / Rubber valve

6866

VOLVO



Jiggle pin / Rubber valve

6867

VOLVO

A: 59,5
B: 25
C: 27



Jiggle pin / Rubber valve

6868

FIAT



Leak Hole on Bypass

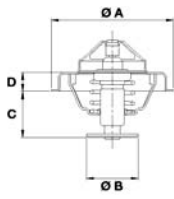

LISTE NUMÉRIQUE

NUMERICAL LIST/AUFLISTUNG

6869

FIAT



Leak Hole on Bypass

6870

HYUNDAI
KIA

A: 54
B: 28
C: 44



6873

BMW

B: 25
C: 32



Jiggle pin inverted

6871

LANCIA



Leak Hole on Bypass

6872

BMW

B: 35
C: 25,5



Jiggle pin inverted / Rubber valve

6874

CITROEN
FORD
MAZDA
PEUGEOT
TOYOTA



Rubber valve

6875

CITROEN
FORD
MAZDA
PEUGEOT
VOLVO



Rubber valve

6876

DAIHATSU
TOYOTA

A: 52
B: 33
C: 47



Jiggle pin inverted

6877

FIAT
LANCIA



Leak Hole on Bypass



LISTE NUMÉRIQUE

NUMERICAL LIST/AUFLISTUNG

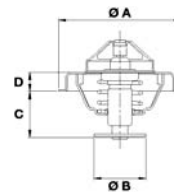

6878

FIAT



6879

FORD

B: 32,5
C: 40



Jiggle pin inversed / Rubber valve

6880

HONDA
LAND ROVER
ROVER



6881

VOLVO



Jiggle pin / Rubber valve

6882

ALFA ROMEO
FIAT
LANCIA



Leak Hole on Bypass

6883

OPEL

A: 54
C: 30



Rubber valve

6884

MERCEDES



Jiggle pin

6920 NEW

MERCEDES



6923 NEW

OPEL
RENAULT



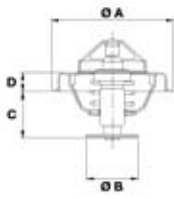

6939 NEW

FORD

B: 33
C: 40



Jiggle pin inversed

6941 NEW

BMW

B: 35
C: 26



Jiggle pin inversed / Rubber valve

6948 NEW

MAZDA



6949 NEW

NISSAN



6952 NEW

LAND ROVER
 ROVER



6950 NEW

CITROEN
 PEUGEOT
 TOYOTA



6953 NEW

MERCEDES



6951 NEW

OPEL



6954 NEW

MERCEDES





LISTE NUMÉRIQUE

NUMERICAL LIST/AUFLISTUNG

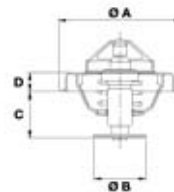

6955 NEW

AUDI



6956 NEW

CHRYSLER



6957 NEW

BMW



6958 NEW

BMW



6959 NEW

HONDA



6960 NEW

JAGUAR



6961 NEW

CHRYSLER



6962 NEW

MERCEDES



6963 NEW

NISSAN



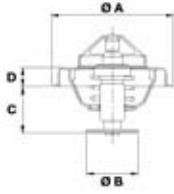

LISTE NUMÉRIQUE

NUMERICAL LIST/AUFLISTUNG

6964 NEW

RENAULT



6965 NEW

AUDI
SEAT
SKODA
VOLKSWAGEN



6966 NEW

VOLKSWAGEN



6967 NEW

AUDI



6968 NEW

AUDI
VOLKSWAGEN



6969 NEW

SMART



6970 NEW

NISSAN
OPEL
RENAULT



6971 NEW

RENAULT



6972 NEW

CITROEN





LISTE NUMÉRIQUE

NUMERICAL LIST/AUFLISTUNG

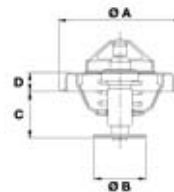

6973 NEW

CITROEN



6974 NEW

MERCEDES



6975 NEW

AUDI
VOLKSWAGEN



6976 NEW

AUDI
VOLKSWAGEN



6977 NEW

AUDI
SEAT
VOLKSWAGEN



6978 NEW

ALFA ROMEO
FIAT
OPEL



6979 NEW

ALFA ROMEO



6980 NEW

FIAT



6981 NEW

FIAT



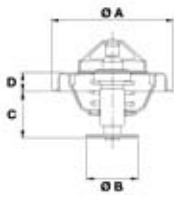

6982 NEW

NISSAN



6983 NEW

FIAT



6984

BMW



6985 NEW

SUZUKI



6986 NEW

FIAT



6988 NEW

AUDI



6989 NEW

AUDI



6990 NEW

PORSCHE



6991 NEW

MERCEDES





LISTE NUMÉRIQUE

NUMERICAL LIST/AUFLISTUNG

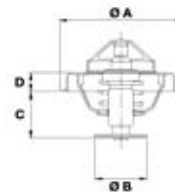

6992 NEW

MERCEDES



6994 NEW

AUDI



CT16958

BMW

A: 73
B: 57,6
C: 37



CT1743

CITROEN
FIAT
LANCIA
PEUGEOT
RENAULT

A: 64
B: 40,9
C: 25



ELO320

VOLVO





CABLES DE RALENTIS

FAST IDdle

LISTE NUMÉRIQUE AVEC PHOTOS
NUMERICAL LIST WITH PICTURES
AUFLISTUNG MIT ZEICHUNGEN

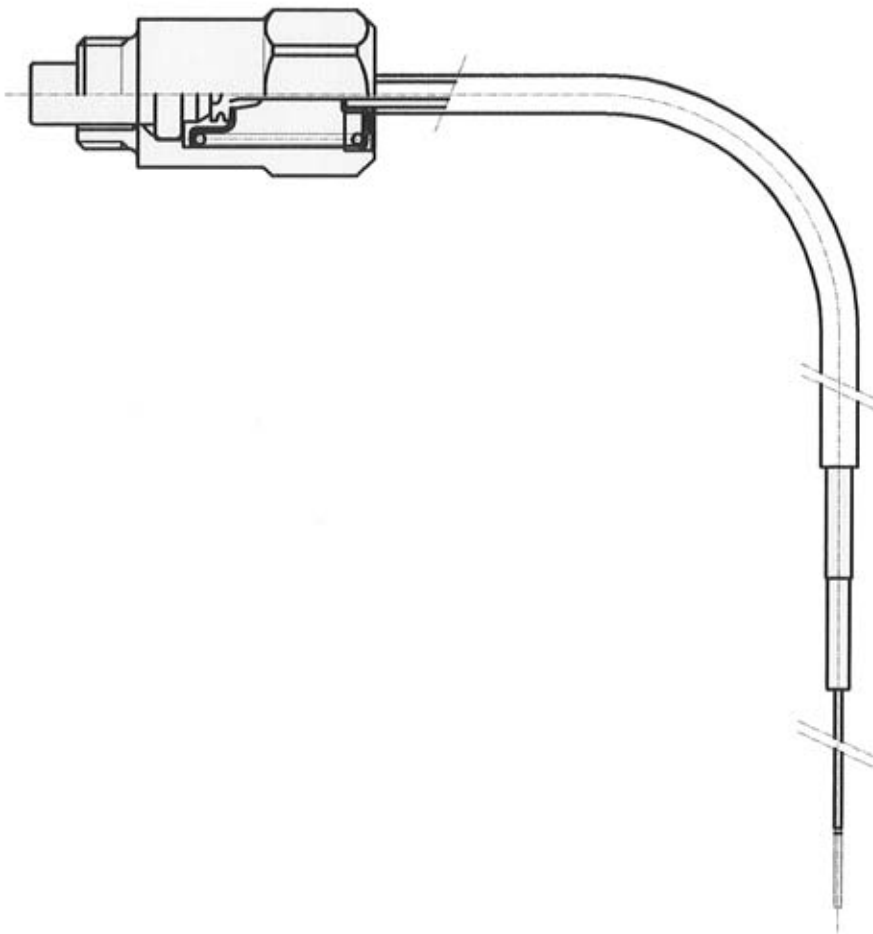



1482

CITROEN
PEUGEOT



1483

RENAULT



2134

RENAULT



2369

RENAULT

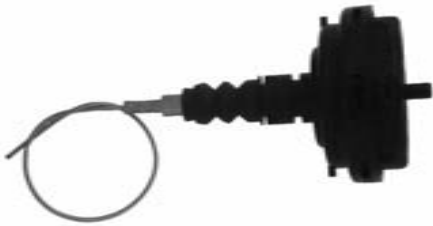



CORRESPONDANCES

CROSS REFERENCES / CROSS LIST



OE	VERNET	OE	VERNET	OE	VERNET	OE	VERNET
ALFA ROMEO		032121110C	6274.80	J9091603099	6312.88	1.123.79	1343.78
0007540318	1514.81	032121110F	5962.82	<hr/>			
0007615234	1514.81	032121113	3349.87	AUTOBIANCHI			
0007730098	5975.80	032121121M	6968.00	0004298930	1522.78	1.125.80	1439.80
0046431723	6254.80	032121121N	6968.00	0004311105	1522.87	1.125.87	1439.87
0046431724	6255.80	035121113	1535.80	0004409254	1519.82	1.129.80	1439.80
0046527104	6576.88	035121113B	5968.87	0007545958	5069.87	1.129.87	1439.87
0046527105	6489.88	036121113	1410.87	0007589135	5069.87	1.130.82	1335.80
0046790294	6826.88	036121113A	1410.92	0007628526	6564.80	1.130.87	1335.87
0046795667	6826.88	036121113B	1410.92	0007656385	6564.80	1.131.75	1508.76
0046822435	6825.88	036121113C	1410.92	0007545958	5069.87	1.132.75	5243.76
0051770698	6979.00	037121113	6434.82	0007589135	5069.87	1.132.79	5243.76
0055181512	6882.88	03C121110A	6965.00	0007628526	6564.80	1.137.82	1514.81
0055181513	6882.88	03G121113	5962.88	0007656385	6564.80	1.140.83	4856.82
0055189843	6882.88	03G121113A	6273.87	0043558460	1519.82	1.140.87	4856.88
0055189845	6882.88	044121113	6273.87	0075459580	5069.87	1.140.92	4856.92
0055194768	6882.88	047121111P	6733.88	0075813190	5069.87	1.143.92	1439.92
0055202176	6986.00	047121111Q	6733.88	<hr/>			
0055202885	6882.88	050121113C	6276.87	BEDFORD			
0060504230	1508.83	052121113	1410.87	94336069	5971.82	1.148.79	1335.80
0060504838	5953.86	052121113A	1410.92	97089891	6252.82	1.148.87	1335.87
0060512869	5967.83	056121113A	1439.80	<hr/>			
0060516212	6463.83	056121113D	1439.87	BEHR			
0060534691	5964.83	059121111F	6994.87	1.033.83	1416.82	1.148.92	1335.92
0060534760	5964.83	059121111L	6994.87	1.041.87	1343.87	1.149.84	3349.84
0060545675	5964.83	059121113	1400.83	1.041.92	1343.90	1.149.87	3349.87
0060547807	5953.86	059121113A	1400.87	1.055.79	1514.81	1.152.87	3359.87
0060556559	5966.87	059121113B	1400.83	1.060.83	1410.83	1.158.76	1514.76
0060557407	5953.86	059121113H	1400.87	1.060.87	1410.87	1.158.82	1514.81
0060563488	6570.80	061121113	6524.82	1.060.92	1410.92	1.158.88	1514.88
0060569028	5966.87	067121113	5968.87	1.061.88	1343.87	1.160.88	5750.88
0060591817	5953.86	068121113B	3349.87	1.069.75	1435.75	1.163.92	5979.92
0060602148	6490.83	068121113D	3349.84	1.069.79	1435.80	1.164.92	6287.92
0060609026	6575.88	068121113H	3349.87	1.070.79	1378.80	1.169.92	6286.92
0060614140	6568.83	069121113	5968.87	1.070.83	1378.83	1.172.88	5750.88
0060653946	6506.88	06A121111A	6975.00	1.070.87	1378.88	1.173.71	1439.71
0060663619	6827.88	06A121114	6976.00	1.070.87	1378.88	1.173.75	1439.75
0060676067	6824.88	06B121111D	6842.100	1.070.92	1378.92	1.173.80	1439.80
0060805288	1514.81	06B121111F	6842.105	1.071.71	1290.73	1.173.87	1439.87
0060808795	6574.80	06B121111G	6842.100	1.071.75	1290.77	1.173.92	1439.92
0060809590	5688.80	06C121111C	6955.92	1.071.83	1290.82	1.180.87	6276.87
0060812296	6254.80	06C121111E	6993.92	1.071.87	1290.88	1.185.84	3349.84
0060812298	6255.80	06D121111G	6988.00	1.071.92	1290.92	1.185.87	3349.87
0060812436	5975.80	06E121111G	6989.00	1.077.92	1410.92	1.186.84	3349.84
0060812437	6537.80	06F121111	6864.105	1.078.87	1410.87	1.186.87	3349.87
0060815681	6551.88	06F121111F	6977.00	1.087.79	1343.78	1.193.92	6251.92
0060816475	6826.88	070121114	6966.87	1.087.83	1343.83	1.194.92	6517.92
0060816881	6825.88	075121113A	5973.87	1.087.88	1343.87	1.407.92	6222.92
0071711978	6570.80	075121113D	5973.80	1.087.92	1343.90	1.408.92	6237.92
10500106400	1290.82	077121113	5902.87	1.090.83	1513.83	1.411.87	6515.87
<hr/>		077121113B	6529.87	1.092.83	1477.82	1.417.87	6514.87
AUDI / VOLKSWAGEN		077121113C	6529.82	1.092.88	1477.87	1.417.87	6514.87
00A121113	6285.87	078121113	5902.87	1.092.92	1477.92	1.774.03	6842.100
022121113	6533.80	078121113C	5902.87	1.095.80	4608.80	1.879.01	6864.105
025121113	6523.87	078121113F	5902.87	1.095.88	4608.88	2.060.71	1528.71
025121113F	6523.87	078121113G	6533.92	1.102.75	3310.75	2.060.80	1528.80
030121113	5151.84	079121113F	6967.87	1.102.80	3310.80	2.063.79	1438.80
030121113A	5151.84	2TA121113	1514.81	1.105.75	1400.77	2.082.71	1476.70
030121113B	5151.87	J9091603046	6484.82	1.105.83	1400.83	2.082.79	1476.79
032121110B	6274.87	J9091603078	6310.88	1.105.88	1400.87	2.082.87	1476.87
<hr/>				1.105.92	1400.90	2.083.71	1435.70
				1.109.75	3310.80	2.083.79	1435.80
				1.114.83	3720.80	2.083.83	1435.80
				1.119.88	1335.87	2.085.71	1513.71
						2.085.75	1513.75



CORRESPONDANCES

CROSS REFERENCES/CROSS LIST

Correspondances

OE	VERNET	OE	VERNET	OE	VERNET	OE	VERNET
...BEHR		2.428.87	6846.87	6.221.79	3309.79	6.413.82	6541.82
2.085.79	1513.80	2.429.87	6850.87	6.221.83	3309.83	6.415.80	6255.80
2.085.83	1513.83	2.430.87	6884.87	6.222.83	1418.72	6.416.88	6504.88
2.086.75	6544.75	2.434.92	6846.92	6.225.83	1400.83	6.417.80	6554.80
2.088.80	1535.80	2.435.92	6884.92	6.225.87	1400.87	6.417.89	6554.80
2.088.87	1535.87	2.445.92	6847.92	6.226.70	6708.70	6.429.87	5953.86
2.090.79	1513.80	2.546.03	6496.105	6.227.83	1514.81	6.439.89	5439.89
2.091.75	1513.75	2.547.01	6493.105	6.231.79	3309.79	8.427.83	1514.81
2.091.79	1513.80	2.561.01	6499.97	6.233.89	6047.89	A.008.75	1417.75
2.093.79	1513.80	2.567.01	6495.105	6.254.80	3905.82	A.008.82	1417.82
2.094.79	1535.80	2.627.02	6939.98	6.255.79	245F.79	A.008.88	6045.89
2.095.80	1535.80	4.116.87	5968.87	6.255.87	245F.79	A.008.88	6148.89
2.095.87	1535.87	4.123.87	5973.87	6.256.79	245F.79	A.060.83	1410.83
2.096.83	1435.83	5.069.79	1435.80	6.256.87	245F.79	A.060.87	1410.87
2.097.80	1535.80	6.022.82	CT13555.82	6.257.80	5070.85	A.060.92	1410.92
2.101.84	6544.75	6.036.82	1519.82	6.258.83	6463.83	A.071.71	1290.73
2.102.75	1513.75	6.036.87	1392.82	6.258.87	6463.83	A.071.77	1290.77
2.105.71	1513.71	6.039.82	1309.82	6.259.80	3905.82	A.071.83	1290.82
2.105.75	1513.75	6.100.75	4495.75	6.260.80	5074.80	A.384.79	1378.80
2.105.79	1513.80	6.100.83	4495.83	6.261.80	5070.85	A.384.83	1378.83
2.105.83	1513.83	6.100.89	4495.89	6.264.80	6253.80	A.384.87	1378.88
2.109.80	5699.80	6.101.83	4495.83	6.265.87	6073.85	A.384.92	1378.92
2.109.85	5699.85	6.102.87	4495.86	6.266.87	6070.87	A.412.82	1477.82
2.112.87	6523.87	6.114.75	1417.75	6.268.80	5687.80	A.454.87	3328.88
2.113.80	5973.80	6.114.83	1417.82	6.271.87	5071.85	B.105.75	1400.77
2.113.87	5973.87	6.114.89	1417.89	6.274.80	5686.80	B.105.83	1400.83
2.114.71	1535.71	6.116.83	1427.82	6.277.83	5964.83	B.105.88	1400.87
2.114.80	1535.80	6.117.83	1183.83	6.282.85	5071.85	B.125.87	1418.83
2.114.87	1535.87	6.117.87	1183.87	6.283.87	5967.83	B.129.80	1439.80
2.118.80	6543.80	6.118.83	1529.83	6.285.83	6598.82	B.129.87	1439.87
2.119.80	5111.80	6.118.89	1529.89	6.285.87	6598.87	B.143.92	1439.92
2.123.88	5111.88	6.119.75	2620.75	6.287.80	5688.80	B.148.87	1335.87
2.124.88	5111.88	6.119.83	2620.82	6.292.86	5953.86	B.148.92	1335.92
2.126.88	5750.88	6.119.88	2620.88	6.301.82	5075.82	B.185.84	3349.84
2.136.80	5699.80	6.121.79	1275.78	6.301.87	5075.88	B.185.87	3349.87
2.136.85	5699.85	6.121.83	1275.84	6.301.88	1477.87	B.296.74	1392.77
2.145.80	6529.87	6.121.88	1275.89	6.302.82	3328.88	B.315.83	1508.83
2.145.87	5902.87	6.122.83	1542.82	6.302.88	3328.88	B.316.86	1508.83
2.145.92	6533.92	6.123.83	1183.83	6.308.82	1477.82	B.346.70	3309.68
2.161.82	6529.82	6.123.89	1183.89	6.308.88	1477.87	B.346.74	3309.74
2.161.87	6529.87	6.124.80	4947.81	6.311.82	5075.82	B.346.79	3309.79
2.350.75	CT16958.76	6.126.75	1415.75	6.311.88	5076.88	B.346.83	3309.83
2.350.82	CT16957.82	6.126.88	1538.88	6.314.82	5075.82	B.390.82	1519.82
2.350.83	CT16957.82	6.130.72	1413.72	6.322.83	1515.81	B.427.83	1514.81
2.361.75	CT16958.76	6.130.75	1414.75	6.325.77	6295.76	B.466.76	1513.75
2.361.82	CT16957.82	6.131.70	1413.72	6.331.83	5079.82	B.471.82	1538.82
2.406.95	6284.95	6.131.75	1414.88	6.331.88	5079.88	B.471.83	1538.82
2.407.87	6285.87	6.131.78	1414.79	6.332.77	1419.77	B.476.74	6034.74
2.408.87	6247.87	6.131.83	1414.84	6.332.88	1419.88	B.476.79	6034.79
2.409.75	CT16054.80	6.131.88	1414.88	6.335.79	6599.78	B.509.79	3309.79
2.409.79	CT1294.79	6.143.87	4640.85	6.336.83	5077.82	B.567.82	1419.82
2.409.82	CT16957.82	6.144.91	5284.91	6.336.88	5077.88	B.741.88	1538.88
2.409.86	CT16953.86	6.145.89	4324.89	6.337.82	6319.82	C.001.75	4495.75
2.413.80	5973.80	6.146.89	1417.88	6.391.83	3357.82	C.001.82	4495.83
2.413.88	5973.87	6.148.83	5130.83	6.391.88	3357.88	C.001.89	4495.89
2.416.95	6498.95	6.200.87	1522.87	6.406.87	3359.87	C.002.87	4495.86
2.421.87	6848.87	6.200.92	1522.92	6.407.83	3720.80	C.295.79	3311.80
2.422.85	6494.85	6.202.87	5069.87	6.410.87	6565.87	C.297.78	1522.78
2.424.88	6941.88	6.220.87	1508.76	6.411.87	5975.80	C.297.87	1522.87
2.426.87	6847.87	6.221.75	3309.74	6.412.80	6570.80	C.342.80	3905.82



OE	VERNET
C.358.85	245F.79
C.360.79	245F.79
C.369.83	6463.83
C.385.80	5070.85
C.395.80	5074.80
C.399.86	5953.86
C.404.80	6253.80
C.430.85	5070.85
C.439.87	6070.87
C.463.87	5964.83
C.468.82	6598.82
C.468.87	6598.87
C.472.87	5069.87
C.493.80	5686.80
C.496.80	5687.80
C.502.82	6592.82
C.503.80	5687.80
C.504.87	5069.87
C.505.80	6560.80
C.510.85	5071.85
C.512.80	5688.80
C.517.87	6565.87
C.519.80	5687.80
C.522.87	6073.85
C.523.83	6070.82
C.525.80	5687.80
C.526.85	5071.85
C.526.88	5071.85
C.530.80	6261.80
C.552.87	6265.87
C.566.87	6264.87
C.568.87	5966.87
C.576.80	5975.80
C.581.80	6536.80
C.584.87	6262.87
C.595.88	5953.86
C.598.87	3359.87
C.599.83	3720.80
C.600.87	6598.87
C.605.80	6263.80
C.614.80	6554.80
C.616.80	6537.80
C.619.87	6266.87
C.623.82	6561.82
C.625.83	6559.83
C.630.82	6541.82
C.630.87	6541.87
C.647.80	6564.80
C.650.87	6731.87
C.657.83	5953.86
C.657.86	5953.86
C.659.80	6570.80
C.661.80	6539.80
C.676.87	6541.87
C.679.83	6490.83
C.683.88	6508.88
C.684.47	6541.87
C.693.80	6553.80
C.700.80	6538.80
C.701.83	6506.83

OE	VERNET
C.701.88	6506.88
C.702.88	6575.88
C.709.88	6557.88
C.710.82	6562.82
C.713.83	6568.83
C.719.75	6555.75
C.723.82	6561.82
C.725.80	6254.80
C.728.80	6254.80
C.729.80	6255.80
C.730.88	6509.88
C.736.82	5687.80
C.739.88	6576.88
C.751.80	6829.80
C.753.80	6830.80
C.754.80	6556.80
C.757.88	6489.88
C.771.75	6258.75
C.772.75	6259.75
C.773.75	6257.75
C.774.75	6256.75
C.784.88	6506.88
C.785.87	6782.87
C.787.80	6553.80
C.787.88	6504.88
C.796.88	6547.88
C.798.80	6550.80
C.799.88	6590.88
C.817.88	6826.88
C.840.88	6551.88
C.845.80	6831.80
C.860.88	6839.88
C.864.88	6827.88
C.908.88	6834.88
D.495.70	6708.70
H.001.82	4495.83
H.001.89	4495.89
H.002.87	4495.86
H.003.83	5353.83
H.004.75	1415.75
H.008.82	5108.83
H.008.88	5108.89
H.013.75	1414.75
H.015.75	1183.75
H.015.82	1183.83
H.016.75	1414.75
H.016.82	1414.84
H.017.75	1538.75
H.017.88	1538.88
H.018.85	1529.89
H.019.79	1414.79
H.022.89	1542.89
H.023.82	4947.81
H.024.82	4947.81
H.026.80	1503.84
H.027.86	5284.86
H.027.91	5284.91
H.031.82	1547.88
H.031.88	1547.88
H.032.83	1418.83

OE	VERNET
H.032.89	1529.89
H.034.82	0963.86
H.035.89	5108.89
H.037.85	4640.85
H.040.83	4885.83
H.041.89	5493.89
H.042.89	6047.89
H.043.89	6488.89
H.045.89	6332.89
H.046.83	5130.83
BMW	
11231265085	1535.80
11232241628	1535.92
11512247269	6941.88
11512354056	6492.88
11517500597	6958.95
11517789014	6872.88
11530139877	6494.85
11531247125	6284.95
11531253249	3310.80
11531254065	1528.80
11531265085	1535.80
11531307737	1528.80
11531315063	CT16958.76
11531407772	CT16958.76
11531432881	6284.95
11531432884	6498.95
11531436042	6495.105
11531436386	6493.105
11531436823	6499.97
11531437040	6499.97
11531437085	6495.105
11531437526	6496.105
11531702279	6497.95
11531704324	6496.105
11531712043	6242.92
11531713040	5111.80
11531721002	5111.88
11531729720	6497.85
11531729841	6497.85
11531731486	6497.70
11531733803	6243.92
11531739755	6284.95
11531743017	6498.95
11531743542	6242.92
11532241628	1535.92
11532243126	5973.80
11532244151	5973.80
11532246199	5973.80
11532246825	5973.80
11532247019	6494.85
11537509227	6499.97
11537510959	6873.105
11537511083	6243.92
11537511580	5111.88
11537536655	6984.00
11717787870	6957.00

OE	VERNET
CATERPILLAR	
2R2911	CT16957.82
4L7615	CT16957.82
4N2212	CT16957.82
4N236	1309.82
4N6958	1439.80
4N6959	1439.80
5H9740	1309.82
5N9389	1309.82
6L5851	CT16957.82
6L7291	CT16957.82
9L9119	1439.80
9L9652	1439.80
9N5020	1439.80
9N5065	1439.80
9N5121	1439.80
9N5488	1439.80
9S9160	CT16957.82
CHEVROLET / DAEWOO	
03038094	4898.92
17670A78B01-000	3328.82
92061279	6501.87
92062728	6222.87
94580182	3328.82
96143939	4898.87
96282726	6502.88
CHRYSLER	
04495721	6843.91
04573560	1477.87
04573560AB	6843.91
04573560AC	6843.91
04693117AA	6570.80
04693117AA	6843.91
04741778	6570.80
04778975	5963.80
04792237AB	6845.88
04973117AA	6843.91
05080146AA	6847.87
05080146AB	6847.87
05080258AA	6961.87
05083288AA	6956.00
05278144AA	6843.91
4494470	1477.87
4573560	1477.87
5278144	6843.91
MD194988	6297.82
MD997310	1477.87
CITROEN	
(Voir / See PEUGEOT)	
1336-F9	5313.85
1336-J1	6541.87
1336-N1	6106.89
1336-Q1	6488.89
1336-Q2	6191.89
1336-V6	6874.83
1336-X2	6875.83



CORRESPONDANCES

CROSS REFERENCES/CROSS LIST

OE	VERNET
...CITROEN	
1337-47	2620.82
1337-65	0963.86
1337-97	1529.89
1338-03	1538.88
1338-04	4945.89
1338-11	5108.89
1338-12	4640.85
1338-18	4780.78
1338-20	4947.81
1338-21	1542.89
1338-23	5130.83
1338-25	5231.83
1338-26	4885.89
1338-37	5108.83
1338-38	5309.84
1338-39	4885.83
1338-44	6148.89
1338-46	5413.84
1338-73	CT1743.82
1338-90	6581.82
1338-A0	6332.89
1338-C8	1542.89
7910011880	1417.88
7910016560	1417.82
90606231	1542.89
91500723	2620.82
93501145	4947.81
95492897	1275.78
95495311	0963.86
95517097	1529.89
95588361	4046.86
95588362	4046.86
96005005	4945.89
96006231	1542.89
96020348	1538.88
96041919	4640.85
96049156	5108.89
96050286	5108.89
96057136	6148.89
96080220	4780.78
96095011	5130.83
96101599	4780.78
96108092	4885.89
96159513	5231.83
96160901	5130.83
9617178080	5108.89
97517097	1529.89
CUMMINS	
111333	1309.82
140669	CT13555.82
146076	CT16850.82
146077	CT16850.82
163981	CT13555.82
167526	1309.82
168391	1309.82
188586	1378.83
199530	CT13555.82
201737	CT16850.82

OE	VERNET
204586	CT16850.82
205566	CT16850.82
3629204	CT16850.82
3907242	3348.83
3917324	3356.83
3928639	3348.83
66255	1309.82
70086	1309.82
DAVIA	
6001543366	5284.91
7700858802	5284.91
7701348068	4495.89
DAEWOO	
(Voir / See CHEVROLET / DAEWOO)	
DAF	
104159	1513.75
240608	5243.76
241955	5241.76
295024	CT16054.80
390455	1513.75
394346	1513.75
609731	1513.83
750562	CT16054.80
DAIHATSU	
16341-87180-000	1416.82
16341-87206-000	3328.82
16341-87208-000	3328.88
16341-87209-000	6828.82
16341-87210-000	3328.82
16341-87280-000	1416.82
16341-87281-000	6828.82
16341-87282-000	3328.88
16341-87283-000	6828.82
16341-87289-000	3328.82
16341-87290-000	3328.88
16341-87582-000	3328.82
16341-87583-000	3328.88
16341-87585-000	3328.82
16341-87780-000	3328.82
16341-87781-000	3328.88
16341-87782-000	1416.82
16341-87783-000	6828.82
16341-87784-000	1416.88
16341-87785-000	1248.80
16341-87786-000	3328.88
16341-87787-000	3328.82
16341-87788-000	5077.82
16341-87789-000	5077.88
16341-87793-000	3328.88
16341-87795-000	3328.88
90048-33001-000	5075.82
90048-33002-000	1416.82
90048-33003-000	1416.82
90048-33004-000	1416.75
90048-33007-000	5077.82

OE	VERNET
90048-33008-000	3328.82
90048-33011-000	3328.88
90048-33012-000	1416.82
90048-33013-000	5077.88
90048-33014-000	1416.88
90048-33015-000	1416.82
90048-33016-000	1416.82
90048-33017-000	1416.88
90048-33019-000	5077.82
90048-33020-000	1416.82
90048-33021-000	1416.88
90048-33022-000	3328.82
90048-33023-000	3328.88
90048-33024-000	5077.88
90048-33025-000	3328.82
90048-33026-000	5077.82
90048-33028-000	5077.82
90048-33029-000	5077.88
90048-33032-000	6525.82
90048-33035-000	1416.82
90048-33040-000	6310.82
90048-33041-000	6310.88
90048-33045-000	6275.78
90048-33047-000	6275.84
90048-33055-000	6275.78
90048-33056-000	6275.84
90048-33058-000	6525.82
90048-33059-000	6525.88
90048-33078-000	6267.82
90048-33088-000	6876.80
90048-33092-000	6267.82
90916-03028-000	5077.82
90916-03031-000	6525.88
90916-03037-000	5075.82
90916-03038-000	1416.82
90916-03040-000	5075.82
90916-03046-000	6484.82
90916-03055-000	6310.88
90916-03059-000	6525.88
90916-03066-000	6525.82
90916-03069-000	6484.82
90916-03077-000	6525.82
90916-03078-000	6310.88
90916-03080-000	6525.88
90916-03083-000	6310.82
90916-03090-000	6484.82
90916-03102-000	6525.82
90916-03103-000	6525.88
EPS	
1880002	1290.82
1880003	1290.88
1880004	1290.92
1880005	5075.82
1880006	1410.92
1880007	4898.92
1880009	2620.75
1880010	2620.82
1880011	4608.80
1880012	4608.88

OE	VERNET
1880013	3357.82
1880015	4856.88
1880016	1538.88
1880019	5898.79
1880022	1335.92
1880023	1418.83
1880025	5115.84
1880027	6248.87
1880028	1439.92
1880030	1519.82
1880032	4493.86
1880033	1413.72
1880034	1413.75
1880035	1248.80
1880036	3328.88
1880038	5075.88
1880040	5971.82
1880041	5971.88
1880044	5077.88
1880045	1528.80
1880046	1535.80
1880047	1535.87
1880049	1441.75
1880050	1476.79
1880052	1476.87
1880053	1535.92
1880054	4947.81
1880055	1183.83
1880056	1533.88
1880057	5699.85
1880060	3311.80
1880061	6596.80
1880062	3720.80
1880063	3310.80
1880065	1522.87
1880066	1522.92
1880067	3359.87
1880069	1514.81
1880071	5750.88
1880072	1400.83
1880075	5111.80
1880076	5111.88
1880079	1435.80
1880081	5979.92
1880082	5069.87
1880083	6598.87
1880084	5686.80
1880086	5074.80
1880088	245F.79
1880091	6070.87
1880092	6073.85
1880093	5071.85
1880094	5687.80
1880077	1417.82
188024	1514.88
F.S.O. / POLSKI	
017102	6593.82
061599	5504.82
063337	5130.83



OE	VERNET	OE	VERNET	OE	VERNET	OE	VERNET
4355846	1519.82	78082	5069.87	0007628526	6564.80	0046527104	6576.88
FACET		78083	6598.87	0007630978	6073.85	0046537267	6831.80
78002	1290.82	78084	5686.80	0007634347	6261.80	0046546375	6551.88
78003	1290.88	78086	5074.80	0007634348	6261.80	0046559840	6868.88
78004	1290.92	78088	245F.79	0007649055	1519.82	0046575242	6708.70
78005	5075.82	78091	6070.87	0007656385	6564.80	0046737644	6782.87
78006	1410.92	78092	6073.85	0007656567	1514.81	0046758434	6832.88
78007	4898.92	78093	5071.85	0007664775	6841.87	0046758586	6869.88
78009	2620.75	78094	5687.80	0007670094	6592.82	0046776216	6504.88
78010	2620.82	78116	6504.88	0007671373	5071.85	0046776217	6590.88
78011	4608.80	78174	6856.92	0007671375	5071.85	0046785392	6826.88
78012	4608.88	FIAT / LANCIA		0007718184	6561.82	0046788769	6871.88
78013	3357.82	000599818	5687.80	0007721399	6536.80	0046790296	6826.88
78015	4856.88	0004154313	1473.88	0007722107	6262.87	0046792658	6832.88
78016	1538.88	0004292856	3905.82	0007723325	6250.87	0046795667	6826.88
78019	5898.79	0004298930	1522.78	0007725918	6541.82	0046800798	6833.88
78022	1508.89	0004306243	6708.70	0007727042	6537.80	0046804764	6834.88
78023	1335.92	0004311105	1522.87	0007729545	6263.80	0046813029	6869.88
78024	1418.83	0004317492	1522.87	0007729959	6264.87	0046822435	6825.88
78025	1514.88	0004331733	245F.79	0007729960	6265.87	0055180041	6835.88
78026	5115.84	0004351196	1519.82	0007730098	5975.80	0055186478	6877.88
78027	6248.87	0004360904	245F.79	0007741883	5976.80	0055189843	6882.88
78028	1439.92	0004409254	1519.82	0007750396	6266.87	0055189845	6882.88
78030	1519.82	0004423976	3905.82	0007756249	6559.83	0055190049	6836.88
78032	4493.86	0004428394	5074.80	0007759596	6731.87	0055194271	6981.88
78033	1413.72	0004440367	245F.79	0007770236	6538.80	0055202176	6986.00
78034	1414.75	0004750024	3309.74	0007770416	6539.80	0055202885	6882.88
78035	1248.80	0004828120	3309.79	0007778653	6541.87	0060556559	5966.87
78036	3328.88	0005495311	0963.86	0007778655	6541.87	0060602145	6509.83
78038	5075.88	0005942240	5686.80	0007789135	5069.87	0060609025	6506.83
78040	5971.82	0005954579	5070.85	0007791178	6508.88	0060620386	6509.88
78041	5971.88	0005964120	3905.82	0007794132	6553.80	0060663619	6827.88
78044	5077.88	0005999536	5071.85	0007794218	6547.88	0060676067	6824.88
78045	1528.80	0005999818	5687.80	0042186490	3311.80	0060812410	6490.83
78046	1535.80	0007303174	3309.79	0042186500	3311.80	0060814382	6506.88
78047	1535.87	0007540318	1514.81	0046411298	6562.82	0060814610	6489.88
78049	1441.75	0007545958	5069.87	0046417962	6557.88	0060815741	6576.88
78050	1476.79	0007574911	5071.85	0046431723	6254.80	0060816475	6826.88
78052	1476.87	0007580642	6550.80	0046431724	6255.80	0060816681	6826.88
78053	1535.92	0007581201	6598.87	0046432157	6839.88	0071744389	6983.00
78054	4947.81	0007581635	6598.87	0046432896	6555.75	0073502809	6980.00
78055	1183.83	0007581916	5071.85	0046440924	6258.75	0082342688	5074.80
78056	1533.88	0007589135	5069.87	0046455054	5687.80	0082390243	6253.80
78057	5699.85	0007589454	6565.87	0046459502	6829.80	0098463638	3309.74
78060	3311.80	0007589824	5687.80	0046464991	6504.88	0098498831	5700.82
78061	6596.80	0007597659	5687.80	0046465699	6504.88	0500329622	6581.82
78062	3720.80	0007597971	6592.82	0046466123	6556.80	1307270080	6554.80
78063	3310.80	0007613245	5688.80	0046470837	6830.80	1307274080	6722.80
78065	1522.87	0007613578	6565.87	0046475733	6256.75	17600-85811	3328.82
78066	1522.92	0007614475	5688.80	0046513506	6504.88	17690-84E50-000	6835.88
78067	3359.87	0007615234	1514.81	0046514952	6878.75	6554000601	3328.82
78069	1514.81	0007615235	1538.88	0046514953	6256.75	9150072380	2620.82
78071	5750.88	0007618716	5687.80	0046517771	6258.75	9605028680	5108.89
78072	1400.83	0007625346	5687.80	0046517772	6259.75	9616090180	5130.83
78075	5111.80	0007625347	5687.80	0046518600	6258.75	9616090280	4885.83
78076	5111.88	0007626622	6070.87	0046518601	6259.75	9617028380	CT1743.82
78077	1417.82	0007626623	6070.87	0046520785	6547.88	9617178080	5108.89
78079	1435.80	0007628332	6560.80	0046522664	6590.88	9630066680	6332.89
78081	5979.92	0007628417	6073.85	0046523118	6782.87	9630066780	6488.89
				0046523733	6504.88		



CORRESPONDANCES

CROSS REFERENCES/CROSS LIST

Correspondances

OE	VERNET	OE	VERNET	OE	VERNET	OE	VERNET
FORD		6169774	6526.88	90443472	6287.92	19300-692-003	5076.82
0801587	1335.87	6176366	6248.87	90443473	5979.82	19300-692-013	5076.82
1001993	5750.92	6182480	1183.83	90466522	6287.82	19300-692-812	5075.88
1002788	6273.87	6201207	3319.88	90486126	6287.82	19300-P08-003	6599.78
1007754	6245.82	6201247	3319.88	90486128	6501.82	19300-P36-003	6484.76
1018799	5973.80	6526879	6244.92	90499660	6249.92	19300-PA0-003	5075.82
1031881	6273.87	6542383	5978.82	90501081	6237.92	19300-PA0-811	5075.88
1059953	1410.92	6588962	5750.88	90501699	6237.82	19300-PB2-003	5076.82
1086282	6526.88	6758566	5977.92	90502201	6249.92	19300-PB2-004	5076.82
1089796	6838.82	6801587	1335.87	90509110	5973.80	19300-PB2-013	5076.82
1096283	5077.88	6866389	5750.88	90529846	6516.92	19300-PB2-014	5076.82
1096699	6273.87	6994257	5977.88	90536262	6517.92	19300-PB2-023	5076.82
1119280	6939.98	7072643	5963.80	90536501	6517.92	19300-PB2-024	5076.82
1122497	6939.98	7334678	5750.88	90537811	6883.82	19300-PB2-811	5076.88
1135768	6939.98	801587	1335.87	90570620	6251.92	19300-PB2-812	5076.88
1148098	6874.83	88EF-8575-AA	4947.81	90572899	6518.92	19300-PB2-813	5076.88
1148164	6838.82	894F8575AA	6007.88	90573326	6519.92	19300-PB2-815	5076.88
1211553	6837.82	89FF8575AA	5750.88	90573926	6855.92	19300-PB2-816	5076.88
1217827	6939.98	ERT106	1535.80	9109738	6923.83	19300-PB2-817	5076.88
1251261	6879.89	ERT122	1410.87	9110579	6923.83	19300-PDA-E01	6267.78
1253116	6837.82	ERT134	1335.80	9110719	6045.89	19300-PE0-013	6599.78
1253118	6837.82	ERT142	1183.83	9112305	6454.89	19300-PE0-024	6599.78
1302261	6939.98	ERT143	1335.87	9112721	6970.83	19300-PE3-013	6599.78
1302391	6837.82	ERT144	1410.92	91138442	1477.82	19300-PE3-024	6599.78
1302396	6837.82	ERT152	5750.88	91159950	6047.89	19300-PH7-004	6267.78
1302397	6837.82	ERT17	1410.87	91160168	6454.89	19300-PH7-014	6267.78
1302398	6837.82	ERT172	5750.88	9129907	6856.92	19300-PH7-024	6267.78
1302402	6837.82	ERT175	1183.83	9158251	6951.92	19300-PH9-003	5075.82
1303374	6837.82	ERT176	5977.88	9161123	6581.82	19300-PH9-004	5075.82
1303377	6837.74	ERT18	1290.92	9201457	6970.83	19300-PH9-811	5075.88
1306001	6837.74	ERT191	5978.82	92063300	6222.92	19300-PH9-812	5075.88
1306004	6837.82	ERT23	1335.87	93177343	6835.88	19300-PH9-F01	5075.82
1312630	6879.89	ERT3	1410.92	93181245	6517.92	19300-PJ7-003	6267.78
1313841	6875.83			93183084	6970.83	19300-PJ7-004	6267.78
1348620	6874.83			94336069	5971.82	19300-PL2-004	6267.78
1358179	6879.89			94372762	5980.88	19300-PLZ-004	6599.78
1452357	1290.88			97087130	6252.85	19300-PM3-003	6267.78
1472378	1290.92			97089891	6252.82	19300-PM3-004	6267.78
1509953	1410.92			97094283	5971.82	19300-PN3-003	6484.76
1612191	1183.83			97135145	6858.89	19300-PN3-004	6484.76
1634617	5750.88			97142431	5504.85	19300-PN4-003	6484.76
1635905	1410.87			97361771	6297.82	19300-PN4-004	6484.76
1658103	6007.88			97687130	6252.85	19300-PR3-003	6267.78
1663819	5750.88					19300-PR7-A01	6297.78
1668305	5978.82					19300-PR7-A02	6297.78
1953232	6314.82					19300-PT0-003	6599.78
1956976	6319.82					19300-PT0-004	6599.78
1957271	6319.88					19301-P07-306	6267.78
3312430	6231.88					19301-P07-316	6267.78
3952532	6578.87					19301-P07-A00	6267.82
4188498	6702.82					19301-P08-000	6267.78
4456486	6578.87					19301-P08-305	6267.78
4495428	6578.87					19301-P08-306	6267.78
6058444	1335.92					19301-P08-315	6267.78
6058784	1535.80					19301-P08-316	6267.78
6100629	1410.92					19301-P10-307	6267.78
6100630	1410.92					19301-P13-000	6267.78
6106381	1335.80					19301-P13-305	6297.78
6129739	1419.82					19301-P13-306	6297.78
6163559	5977.88					19301-P1K-307	6296.78
		GENERAL MOTORS					
		12992692	6251.92	HONDA			
		24414452	6854.92	19300-611-003	1416.82		
		24420652	6249.92	19300-611-005	5076.82		
		24420728	6249.92	19300-634-671	5075.82		
		24435781	6855.92	19300-634-812	5075.88		
		24435785	6516.92	19300-634-961	5075.88		
		24447862	6853.92	19300-657-000	5076.82		
		24456401	6517.92	19300-657-003	5076.82		
		2898440	5962.92	19300-657-811	5076.82		
		55202510	6978.88	19300-657-812	5076.82		
		8966483	1439.80	19300-679-003	5075.82		
		8966485	6248.87	19300-679-004	5075.82		
		90009956	1335.92	19300-679-014	5075.82		
		90067918	1439.92	19300-679-811	5075.88		
		90194185	1290.88	19300-679-812	5075.88		
		90200836	4898.92	19300-679-813	5075.88		
		90220435	6287.92				
		90232012	5979.92				
		90322033	6501.92				
		90352677	6286.92				
		90354822	6287.82				
		90410897	6249.92				
		90411948	6222.92				
		90412604	1439.80				
		90412901	6171.92				



OE	VERNET
19301-P8A-A00	6267.78
19301-P8A-A10	6267.78
19301-P8A-A11	6267.78
19301-P8C-A10	6583.76
19301-P8C-A11	6583.76
19301-P8E-305	6267.78
19301-P8E-A10	6267.78
19301-P8F-A10	6267.78
19301-P8F-A11	6267.78
19301-PAA-305	6267.78
19301-PAA-306	6267.78
19301-PDA-E01	6267.78
19301-PHM-305	6267.88
19301-PLC-305	6267.78
19301-PLC-A00	6267.78
19301-PLC-A05	6267.78
19301-PLZ-D00	6252.85
19301-PNA-003	6959.00
19301-PR7-305	6297.78
19301-PR7-306	6297.78
19301-PR7-307	6297.78
19301-PR7-309	6297.78
19301-PR7-A01	6297.78
19301-PWA-305	6267.82
19301-PZA-305	6267.82
19301-RBD-305	6297.78
19302-P5T-G00	6880.00
19302-P5T-G01	6880.00
19320-679-000	5075.82
19320-679-810	5075.88
19320-679-F00	5075.82

HYUNDAI

25500-02500	6484.82
25500-02550	3328.82
25500-11200	5075.82
25500-21210	5075.88
25500-21220	5075.88
25500-22050	6580.88
25500-22200	6293.82
25500-22250	6580.88
25500-22600	1290.88
25500-23001	6294.82
25500-23010	6294.82
25500-24000	5075.82
25500-27000	6319.85
25500-27000AT	6319.85
25500-33040	5075.88
25500-33050	5075.88
25500-33060	5075.88
25500-35531	6297.82
25500-35540	6297.82
25500-37200	6297.82
25500-38001	6870.82
25500-38001AT	6870.82
25510-42100	6840.82
25511-29000	5130.83

INNOCENTI

0004409254	1519.82
------------	---------

OE	VERNET
0007589824	5687.80
0007625346	5687.80
0007649055	1519.82
0007671373	5071.85
0007725918	6541.82
6554000601	3328.82

ISUZU

8-94336-069-0	5971.82
8-97089-891-0	6252.82

IVECO

4630916	1508.84
4684390	3309.79
4703088	3309.79
4718879	CT1294.79
4738161	1513.80
4739264	3309.74
4749727	1513.75
4750024	3309.74
4807492	1513.80
4807495	1513.75
4809019	3309.74
4809509	3309.74
4823211	3309.79
4837166	5898.79
61673540	1513.71
7301138	3309.74
7303174	3309.79
7303615	6581.82
7403088	3309.74
98420718	1476.79
98424854	1476.79
98463637	6581.82
98463638	3309.74
98467517	1476.79
98498831	5700.82
99431512	CT16901.85

JAGUAR

(Voir / See LAND ROVER / ROVER)

AJ82600	5753.84
AJ86484	5753.84
C2S11278	6960.82
EBC3576	1514.81
EBC3621	6246.88
JDE1275	6312.88
JLM322	6246.88
XR85174	6578.87

JEEP

05080146AA	6847.87
05080146AB	6847.87
4494469	5812.92
5073598AA	6845.88
52079476AB	6845.88
52079476AC	6845.88
53010552AA	6843.91
7700665226	4947.81

OE	VERNET
7700697157	1547.88
7701349415	1533.88
7700657955	1533.88
7700665226	4947.81
7700697157	1547.88
7701349415	1533.88
83501426	1378.88
8983501426	6244.92
T0697157	1535.80

JOHN DEERE

AA575012	1309.82
AB474512	1309.82
AF152212	CT13555.82
AF171012	CT13555.82
AF22290	1309.87
AF22298	1309.87
AR61538	5792.83
AT23070	CT13555.82
AT23908	CT13555.82
R3267612	1309.82
R3457812	1309.82

KIA

OK013-15-171	5075.88
OK054-15-171	5980.88
OK201-15-171	5075.82
OK2A1-15-171	5075.82
OK2C0-15-171	5075.88
OK2C0-15-171A	5075.88
OK30E-15-171	5075.88
OK410-15-171A	6580.88
OK710-15-171	5980.88
OK9FC-15-171	6292.88
25500-27000	6319.85
25500-27000AT	6319.85
25500-37200	6297.82
25500-38001	6870.82
25500-38001AT	6870.82
KE5D3-15-171	6292.88
KHE41-15-171	5075.82
MHE41-15-171	5075.82

LADA

103-130-6010-04	6597.87
112-1306010-06	6597.87
16210001	6779.82
16210003	6779.82
20095-1306015	1542.89
20195-1306015	1542.89
21010-1306010	3720.80
2101-1306010	3720.80
2101-1306010-01	3720.80
2101-1306010-02	3720.80
21073-1306010	3720.80
21080-1306010-503359.87	
2108-1306010	3359.87
2108-1306010-10	3359.87
2108-1306010-11	3359.87

OE	VERNET
2108-1306010-12	3359.87
2108-1306010-50	3359.87
21082-1306010	6780.85
21083-1303014-106780.85	
2109-1306010	6780.85
21095-1306015	1542.89
21100-1306010-006595.85	
21100-1306010-506595.85	
2110-1306010	6595.85
21120-1306010	6595.85
2121-1306010	6596.80
21215-1306015	5130.83
2141-1306010	6603.80
412-130-3010-1	6595.85
412-1306008	6603.80
412-130-6010-0	6595.85
412-1306010-10	6603.80
412-2140-2141	6603.80
TC103-1306010-04	6597.87
TC10701	6779.87

LANCIA

(Voir / See FIAT / LANCIA)

LAND ROVER

563122	6510.78
602687	6510.82
ERR2803	1419.88
ERR3291	6511.88
ETC4761	6510.74
ETC4763	6510.82
ETC4765	6510.88
PEL000060	6493.105
PEL10016	5955.88
PEL100570L	6952.88
PEL500110	6880.00
PEM100990	6880.00
RTC6673	5963.80
STC3338	5973.80

LEXUS

90916-03084	6295.82
-------------	---------

MAN

51064020002	1378.80
51064020034	1513.80
51064020043	1513.80
51064020050	1513.80
51064020053	1513.80
51064020056	1513.80
51064020061	1513.80
51064020064	1513.80
51064020067	1513.80

MARUTI

17600-82810	3328.82
17670-82000	3328.82



CORRESPONDANCES

CROSS REFERENCES/CROSS LIST

Correspondances

OE	VERNET
MASSEY-FERGUSON	
1002-522-M91	1435.80
1007-442-M91	1435.80
1007-442-M92	1435.80
1446-165M91	1378.80
181-566M1	1378.80
184-206M1	1378.80
185-55313M91	1378.80
187-437M91	1378.80

OE	VERNET
MAZDA	
0118-15-171A	3328.82
0187-15-171A	3328.82
0223-15-171C	5075.82
0223-15-171D	6292.88
0259-15-171	3328.82
0259-99-152	3328.82
0419-15-171	5075.82
0419-99-152	5075.82
0603-99-152	1416.75
0604-15-171	1416.75
0839-15-171A	1419.82
OK013-15-171	5075.88
OK2C0-15-171A	5075.88
OK710-15-171	5980.88
OK9FC-15-171	6292.88
1259-15-171	1419.82
1259-99-152	1419.82
1316-15-171A	6580.82
1345-99-152	5075.82
1346-15-171	5075.82
1346-99-152	5075.82
1363-15-171A	6580.82
1363-99-152	6580.82
1A04-15-171	3328.88
1A50-15-171	6737.82
1A51-15-171	6702.82
1E03-15-171	6244.92
1E05-15-171	6844.82
1E05-15-171A	6844.82
1E07-15-171	6526.88
1E07-15-171A	6526.88
1N00-15-171	1419.82
1N01-15-171	1419.88
1N02-15-171	6295.88
1N03-15-171	6484.76
1N04-15-171	6484.76
1N05-15-171	6484.76
1N09-15-171	6295.82
1N13-15-171	6314.76
2228-15-171	1416.82
2228-99-152	1416.82
5E01-15-171	5980.88
6173-99-152A	1416.82
8118-15-171	5075.88
8124-15-171	5075.88
8124-99-152	5075.88
8173-15-171	5075.88
8173-99-152	5075.88
8173-99-152A	5075.88

OE	VERNET
8173-99-152B	5075.88
8553-15-171	6319.82
8553-99-152	1419.82
8AB1-15-171	6292.88
8AB2-15-171	6580.88
8AB3-15-171	1514.81
8AB3-15-171A	6580.88
8AB4-15-171	6580.88
8AB4-15-171A	1419.82
8AB7-15-171	5075.82
8AB8-15-171	6292.88
8AB9-15-171	5076.82
8ABA-15-171	5075.88
8ABB-15-171	5075.88
8ABB-15-171A	5075.88
8ABC-15-171	5075.82
8ABD-15-171	5075.88
8ABE-15-171	5076.88
8AF1-15-171	1419.82
8AG1-15-171	5980.88
8AG1-15-171A	5980.88
8AG2-15-171	5980.88
8AG2-15-171A	5980.88
8AG3-15-171	6292.88
8AG4-15-171	5075.88
8AG5-15-171	6292.88
8AG6-15-171	5980.88
8AG7-15-171	6292.88
8AG8-15-171	5980.88
8AGX-15-171	6702.82
8AK1-15-171	6292.88
8ANI-15-171	6292.88
8AP1-15-171A	5075.82
8AU-15-171	6292.88
8AW2-15-171	6580.88
8AW4-15-171	6580.88
8AX1-15-171	5075.88
8AZ1-15-171	5980.88
8BA1-15-171	3328.82
8BA2-15-171	3328.88
8BA2-15-171A	3328.88
8BP1-15-171	5075.82
AY01-15-171	3328.88
AZ10-15-171	3328.82
B541-15-171	5075.88
BP6F-15-171	5075.88
BP6F-15-171A	5075.88
C201-15-171	6844.82
ESD3-15-171	6292.88
ERR2803	1419.88
F201-15-171	6292.88
F201-15-171A	6292.88
FS05-15-171	6702.82
GTS302	1427.88
HE41-15-171	5075.82
HE41-99-152C	5075.88
HE41-99-152D	5075.82
JEB5-15-171	6702.78
KL01-15-171	6702.82
KL01-15-171A	6702.82

OE	VERNET
MD005131	1416.88
MD005371	1416.82
N326-15-171	1419.82
N3H1-15-171	6948.82
PEL10017	1427.88
PEL100570L	6952.88
PN16-15-171	6580.88
PN20-15-171	6580.88
RF01-99-152	5971.88
RF01-99-152	5971.88
RF01-99-152A	5971.88
RF03-15-171A	5980.88
S204-15-171	6580.88
S204-99-152	6580.88
S282-15-171	6580.88
S282-99-152	6580.88
SE01-15-171	6580.82
SE08-15-171	6580.82
SE08-99-152	6580.82
SE09-15-171	1419.75
SE09-99-152	1419.75
SE09-99-152A	1419.75
SL01-99-152	6580.88
SL09-15-171	6580.82
SL09-99-152A	6580.82
SLM1-15-171	6580.88
SLM1-15-171B	6580.88
V707-15-171	6252.85
Y401-15-1H0	6874.83
Y602-15-17X	6875.83
Y707-15-171	6252.85
YF09-15-171	5750.92
ZZ40-15-171	6292.88
ZZ50-15-171	3328.88
ZZS2-15-171	3328.88
ZZS3-15-171	3328.88
ZZS4-15-171	3328.88

MERCEDES	
0022033575	1476.79
0022037575	1535.80
0022037675	1476.87
0022037676	1476.87
0022037775	1441.75
0022037875	1476.79
0022037975	1513.71
0022038075	1535.87
0022038175	1476.87
0022038275	1441.75
002238075	1535.87
0032037375	1513.83
0032037475	1513.83
0032037875	1513.83
0032037975	1513.71
0032039975	5699.85
0042030975	5699.80
0042031075	5699.85
0042038675	1476.92
1002000515	1476.87
1002000715	1476.79

OE	VERNET
1022001415	1476.87
1022001515	1476.87
1022001915	5963.92
1102000515	1476.87
1102000915	1513.71
1112000315	6247.87
1112000815	6285.87
1112000915	6285.87
1112001715	6954.87
1122000015	6513.87
1122030275	6513.87
1122030375	6974.87
1152000615	1513.83
1162000015	6544.75
1162000315	6543.80
1192000015	6849.80
1662030175	6514.87
1662030275	6514.87
2662030275	6991.00
2712000015	6962.90
6012000015	5699.85
6012000115	5699.80
6022000015	5699.80
6022033575	1476.79
6112000015	6920.87
6112000115	6848.87
6112000315	6846.87
6112000415	6884.87
6112000515	6846.92
6112000615	6884.92
6112000715	6847.87
6122000015	6850.87
6132000015	6846.92
6132000115	6846.92
6152001315	1535.80
6162000415	1535.80
6172000815	1535.80
6172001815	1535.80
6282030175	6953.92
6462000015	6847.92
6462000415	6992.00
6602000315	6969.00
6642000015	6961.87
6682030075	6515.87
6682030275	6515.87

MINI	
11531485847	6843.91
11537791072	6587.82

MITSUBISHI	
31646-02401	1419.82
31646-02402	1419.82
31646-02502	1419.82
31646-02702	5792.83
M474877	6318.89
M863985	6318.89
MD-001370	5075.82
MD005131	1416.88
MD005371	1416.82



CORRESPONDANCES

CROSS REFERENCES/CROSS LIST

OE	VERNET	OE	VERNET	OE	VERNET	OE	VERNET
...MOVI		3002.83	1513.83	3047.83	6484.82	3324.80	5071.85
2022.82	1417.82	3003.83	5792.83	3047.88	5079.88	3325.82	6598.82
2023.83	1378.83	3004.83	5792.83	3048.82	5077.82	3325.87	6598.87
2023.91	1378.92	3005.80	245F.79	3048.83	5077.82	3326.80	5687.80
2024.82	5108.83	3007.78	1418.77	3048.88	5077.88	3327.80	3905.80
2024.89	5108.89	3007.83	1418.83	3049.82	1538.82	3328.80	5074.80
2025.88	1410.87	3008.74	1419.75	3049.83	1538.82	3329.80	5687.80
2026.80	1522.78	3008.82	1419.82	3049.88	1538.88	3330.79	245F.79
2026.85	1522.87	3012.80	1439.80	3050.82	1514.81	3331.85	5071.85
2027.85	1410.83	3013.83	1183.83	3050.88	1514.88	3332.82	6592.82
2027.91	1410.92	3014.92	1335.92	3051.88	5750.88	3333.87	6565.87
2028.78	4493.75	3015.83	1529.83	3052.83	5353.83	3334.80	5688.80
2028.83	4493.86	3015.89	1529.89	3053.80	5111.80	3339.80	5070.85
2028.87	4493.86	3016.80	4947.81	3053.88	5111.88	3340.80	6253.80
2028.89	4493.89	3017.83	1418.83	3054.79	1476.79	3344.80	245F.79
2029.83	1410.83	3018.84	3349.84	3054.87	1476.87	3345.87	3359.87
2029.92	4898.92	3018.87	3349.87	3057.82	1419.82	3346.80	6564.80
2031.88	1410.87	3019.80	4947.81	3058.75	1476.75	3347.87	6264.87
2032.78	1417.78	3020.80	4856.80	3058.87	1476.87	3348.87	6262.87
2032.82	1417.82	3021.80	1335.80	3059.87	5902.87	3349.82	6561.82
2033.78	6070.82	3021.83	1439.80	3061.87	1439.87	3350.87	6265.87
2033.87	6070.87	3021.92	1439.92	3062.88	5750.88	3351.87	6250.87
2034.82	5962.82	3022.80	1183.83	3066.76	1514.76	3352.82	6541.82
2035.78	1417.78	3023.78	6319.76	3066.81	1514.81	3353.80	5976.80
2035.82	1417.82	3023.81	6319.82	3067.83	5130.83	3354.80	6536.80
2036.85	6073.85	3024.92	1439.92	3068.79	4780.78	3355.87	5966.87
2036.87	6073.85	3025.83	1535.80	3069.83	5130.83	3357.83	6490.83
2037.89	6148.89	3025.87	1535.87	3070.87	6273.87	3358.80	6254.80
2038.86	5284.86	3026.83	5130.83	3071.89	6332.89	3359.80	6263.80
2039.83	5108.83	3026.87	5968.87	3072.80	5973.80	3360.80	6537.80
2039.89	5108.89	3028.83	6463.83	3073.79	6599.78	3362.86	5953.86
2040.82	5075.82	3030.81	4947.81	3200.92	6287.92	3363.80	5975.80
2040.88	5075.88	3031.88	1533.88	3201.92	5979.92	3364.80	6570.80
2041.82	3328.82	3032.81	4947.81	3202.75	CT16958.76	3365.87	6541.87
2041.88	3328.88	3034.80	1439.80	3203.80	4608.80	3366.80	6553.80
2042.82	0963.80	3034.87	1439.87	3204.85	5699.85	3367.80	6539.80
2042.86	0963.86	3035.84	3349.84	3205.82	5075.82	3370.80	6255.80
2043.82	5955.82	3035.87	3349.87	3206.87	6274.87	3371.80	6722.80
2043.88	5955.88	3036.83	5130.83	3207.92	6251.92	3375.88	6557.88
2044.85	4640.85	3036.89	5130.89	3208.92	6171.92	3376.88	6508.88
2045.82	5075.82	3037.76	5241.76	3209.92	6249.92	3377.88	6504.88
2045.88	5075.88	3038.76	6319.76	3210.89	5493.89	3378.88	6509.88
2046.82	5076.82	3038.82	6319.82	3211.88	5980.88	3380.82	6562.82
2046.88	5076.88	3038.88	6319.88	3303.83	1508.83	3383.80	6261.80
2047.74	1290.73	3039.80	1439.80	3303.86	1508.89	3388.83	3720.80
2047.79	1290.77	3039.87	1439.87	3304.74	3309.74	3389.80	6596.80
2047.83	1290.82	3040.82	1542.82	3304.79	3309.79	3393.83	6568.83
2047.87	1290.88	3040.89	1542.89	3305.79	5898.79	3395.88	6489.88
2048.82	1477.82	3041.82	1529.83	3306.82	1519.82	3396.88	6576.88
2048.88	1477.87	3042.76	1515.76	3309.82	1183.83	3401.75	6258.75
2049.89	6045.89	3042.81	1515.81	3311.88	1533.88	3402.75	6256.75
2050.89	6047.89	3042.83	1515.81	3312.86	5953.86	3403.75	6259.75
2051.92	6244.92	3043.75	1400.77	3314.86	5953.86	3404.75	6256.75
2052.87	6276.87	3043.83	1400.83	3317.83	5964.83	3405.75	6555.75
2053.83	4885.83	3043.88	1400.87	3318.87	5069.87	3407.88	6590.88
2055.89	6488.89	3044.87	5902.87	3319.80	6564.80	3408.88	6506.88
2115.78	1522.78	3045.76	1514.76	3320.80	5686.80		
2115.87	1522.87	3045.81	1514.81	3321.85	5070.85	NISSAN	
3002.75	1513.75	3045.83	1514.81	3322.85	5071.85	11060-00QAJ	6703.83
3002.80	1513.80	3047.82	5079.82	3323.80	5070.85	11060-AW300	6454.89

Correspondances



CORRESPONDANCES

CROSS REFERENCES/CROSS LIST

OE	VERNET	OE	VERNET	OE	VERNET	OE	VERNET
11060-BN700	6666.89	21200-6N210	6314.82	21200-G2401	6319.88	1338014	6249.92
11061-00QAB	6454.83	21200-76202	1419.75	21200-G3100	1378.83	1338015	6857.92
11061-00QAC	6970.83	21200-76203	1419.75	21200-G3160	1378.83	1338016	5962.92
11061-00QAD	6454.89	21200-76204	1419.82	21200-H7800	5971.82	1338017	6853.92
11061-00QAE	6126.89	21200-76205	1419.75	21200-H7802	1378.77	1338018	1378.88
11061-00QAG	6666.89	21200-76206	1419.88	21200-HC000	5075.88	1338024	1439.80
11061-00QAK	6970.83	21200-76207	1419.75	21200-HC200	5980.88	1338028	1439.92
21200-01B00	3328.88	21200-77A00	5079.76	21200-HC250	5980.88	1338033	6248.87
21200-05B00	3328.82	21200-77A05	3357.82	21200-HC400	5075.88	1338038	1439.92
21200-05D00	6319.82	21200-77A60	5079.76	21200-HC430	5075.88	1338046	1335.92
21200-05D01	1419.82	21200-77A61	3357.82	21200-P6500	6313.88	1338049	5979.92
21200-05D02	1419.82	21200-77A63	3357.76	21200-P7500	5971.88	1338050	6287.92
21200-05D10	6319.88	21200-77A65	3357.82	21200-P7900	5971.82	1338051	1439.92
21200-05D11	1419.88	21200-77A66	5079.82	21200-P7901	5971.82	1338052	4898.92
21200-05D12	6319.88	21200-78500	1378.83	21200-P7905	5971.88	1338055	1290.88
21200-0B000	6851.82	21200-78501	1378.88	21200-P7906	5971.88	1338056	5980.88
21200-0C810	6314.76	21200-78502	1378.77	21200-P7990	5971.82	1338057	6287.82
21200-0C811	6314.76	21200-78503	1378.88	21200-P7991	5971.88	1338060	6286.92
21200-16A00	6314.82	21200-78505	1378.88	21200Q9000	5971.88	1338061	1439.80
21200-16A05	6314.82	21200-78506	1378.88	21200-T8300	1378.77	1338062	5979.82
21200-16A10	6314.76	21200-78510	1378.83	21200-TB300	1378.77	1338063	6287.92
21200-22J00	6851.82	21200-78511	1378.83	21200-V0100	5971.82	1338067	6249.92
21200-2H600	5971.82	21200-78512	1378.83	21200-V0105	5971.88	1338068	6222.92
21200-2H605	5971.88	21200-78515	1378.88	21200-V0200	1290.82	1338069	6501.82
21200-2W201	6295.82	21200-80W05	5971.88	21200-V0201	5971.82	1338070	6287.92
21200-2W202	6295.82	21200-85G00	5971.82	21200-V0205	5971.88	1338072	1477.82
21200-31U03	6861.82	21200-85G05	5971.88	21200-V0206	5971.88	1338073	6171.92
21200-31U13	6860.82	21200-85G06	5971.88	21200-V0700	1419.82	1338074	6252.82
21200-40F00	6314.76	21200-86J00	5079.82	21200-V0705	1419.88	1338075	6252.85
21200-41B00	5971.82	21200-86J01	5079.82	21200-V0710	1419.75	1338076	5973.80
21200-42L00	6851.76	21200-89J00	6314.82	21200-V5010	6851.76	1338077	5971.82
21200-42L01	6851.76	21200-8J100	6982.00	21200-V5015	6851.76	1338078	6249.92
21200-47R00	6314.82	21200-90J10	5079.82	21200-V7205	6851.82	1338079	6237.92
21200-49701	6319.88	21200-93J00	6314.76	21200-V7206	6851.82	1338080	6237.82
21200-4M500	5079.82	21200-93J01	6314.76	21200-W3300	1419.82	1338082	5973.80
21200-4M510	6484.82	21200-93J10	6314.82	21200-W3305	1419.82	1338084	6249.92
21200-4W010	6860.76	21200-96011	6319.82	21200-W3310	1419.77	1338087	6516.92
21200-50K00	6314.76	21200-96012	6319.88	21200-Y9700	6963.81	1338093	5504.85
21200-53J00	6314.76	21200-96015	1419.71	21200-Y9701	6319.88	1338094	6501.92
21200-53J10	6314.76	21200-99B02	6313.82	21202-96002	1419.82	1338096	6251.92
21200-57J00	6295.82	21200-99B03	6313.82	21207-96000	1419.75	1338097	6855.92
21200-57J05	6295.88	21200-99B12	6313.88	21207-96002	1419.82	1338098	6517.92
21200-57J10	6295.76	21200-99B13	6313.88	21208-96000	1419.75	1338100	6518.92
21200-57J15	6295.82	21200-9F500	6314.82	21208-96001	1419.82	1338154	6978.88
21200-58G00	1419.75	21200-9F600	5079.82	21208-96002	1419.82	1338275	6978.88
21200-58G01	1419.82	21200-A3000	1378.83	21209-96001	6319.88	1338331	6519.92
21200-58G02	5792.76	21200-A3001	5971.82	21209-96002	1419.82	1338466	5963.80
21200-58G04	5792.76	21200-A3005	5971.82	21209-96011	1419.88	1338478	6222.92
21200-58G05	1419.82	21200-AD201	6297.82	21209-96012	1419.82	1348049	5979.92
21200-58G06	1419.82	21200-B8202	1378.77	74300064-0	1538.82	4304369	5971.82
21200-60J00	6314.82	21200-BB202	1378.77			4400106	5898.76
21200-60J10	6314.82	21200-BN300	6583.82	OPEL		4400311	6320.89
21200-60J11	6314.82	21200-BN301	6583.82	1338001	6517.92	4401738	6923.83
21200-61000	1378.77	21200-BX000	1290.88	1338003	6856.92	4402579	6923.83
21200-61001	1378.83	21200-E0700	1378.83	1338004	6951.92	4402719	6045.89
2120061002	1378.83	21200-ED000	6949.82	1338005	6858.89	4404305	6454.89
2120062401	6319.88	21200-F3100	1378.77	1338007	6883.82	4404721	6970.83
21200-69T06	5079.82	21200-F3160	1378.77	1338008	6883.82	4408334	6047.89
21200-6F900	1542.89	21200-F3190	1378.77	1338009	6855.92	4408928	6454.89
21200-6F901	1542.89	21200-G2400	1419.82	1338010	6516.92	4415794	6970.83

Correspondances



CORRESPONDANCES

CROSS REFERENCES/CROSS LIST

OE	VERNET
...OPEL	
4500823	6581.82
4506048	6970.83
6338004	6854.92
6338005	6517.92
6338014	6297.82
6338017	6517.92
6338022	6835.88
6338028	6251.92
6338029	6297.82
6338035	6517.92
93215644	6287.82
93275736	6764.92

PEGASO

770275	1513.75
770662	CT16958.76

PERKINS

4A236M	1290.73
PF52842	1378.83

PEUGEOT

1336-A7	5687.80
1336-F9	5313.85
1336-J1	6541.87
1336-N1	6106.89
1336-N5	6488.89
1336-Q1	6488.89
1336-Q2	6191.89
1336-V6	6874.83
1336-X1	6756.84
1336-X2	6875.83
1336-Z0	6972.91
1336-Z2	6808.103
1337-18	2150.75
1337-20	1415.75
1337-25	1413.72
1337-26	1414.75
1337-27	6148.89
1337-30	5108.83
1337-34	1183.83
1337-35	1427.82
1337-40	1503.72
1337-47	2620.82
1337-48	1538.82
1337-49	2620.75
1337-53	1418.83
1337-54	1542.82
1337-59	1503.80
1337-64	4947.81
1337-65	0963.86
1337-66	1503.78
1337-68	3327.81
1337-97	1529.89
1338024	1439.80
1338-03	1538.88
1338-04	4945.89
1338-08	4945.89

OE	VERNET
1338-11	5108.89
1338-12	4640.85
1338-14	4780.78
1338-16	4949.89
1338-18	4780.78
1338-20	4947.81
1338-21	1542.89
1338-23	5130.83
1338-24	5229.83
1338-25	5231.83
1338-26	4885.89
1338-36	1468.82
1338-37	5108.83
1338-38	5309.84
1338-39	4885.83
1338-44	6148.89
1338-46	5413.84
1338-73	CT1743.82
1338-83	5108.83
1338-90	6581.82
1338-A0	6332.89
1338-E4	6973.105
1338-E8	6950.82
91500723	2620.82
96005005	4945.89
96006231	1542.89
96020348	1538.88
96041919	4640.85
96049156	5108.89
96050286	5108.89
96057136	6148.89
96095011	5130.83
96108092	4885.89
96160901	5130.83
97517097	1529.89

PIAGGIO

16341-87795-000	3328.88
-----------------	---------

PORSCHE

059121113B	1400.83
92810612905	1435.80
94410612905	1439.80
99610612552	6862.83
99610612570	6990.83
99610612572	6990.83

PROTON

MD315301	6295.82
MD317015	6295.76
MD337408	6295.82
MD972903	5075.88
MD997604	5075.88

RENAULT

21200-31U03	6861.82
5000815791	5898.79
5000816924	5898.76
6000007566	3335.88

OE	VERNET
7431397947	1400.90
7436842409	1400.90
7439180811	1400.90
7700109641	6320.89
7700110716	6126.89
7700112491	6923.89
7700578467	1183.83
7700613673	4495.75
7700627940	4495.86
7700657954	1533.83
7700657955	1533.88
7700665226	4947.81
7700697157	1547.88
7700703136	1183.86
7700722762	4493.86
7700726662	4168.89
7700727190	4324.89
7700730540	4493.89
7700735456	4168.78
7700858802	5284.91
7700862200	5083.83
7700862727	5286.78
7700866896	6045.89
7700868274	5446.83
7700868980	5493.89
7700872314	6045.89
7700872554	6047.89
7700966896	6045.89
7701026647	5898.79
7701035736	5700.82
7701038494	5353.83
7701039156	5700.82
7701042512	5898.79
7701052705	6583.82
7701057805	6583.82
7701348068	4495.89
7701348139	1503.84
7701348340	4495.86
7701348372	1417.82
7701348373	1417.89
7701348374	4495.86
7701348375	4495.75
7701348376	4495.83
7701349314	4493.86
7701349415	1533.88
7701474248	6923.89
7701474249	6320.89
7701474510	6860.82
7701716338	6320.89
7901245278	1183.83
8200021008	6970.83
8200023915	6964.89
8200039885	6666.89
8200074346	6454.89
8200074349	6454.83
8200112054	6628.89
8200125655	6045.83
8200154296	6970.83
8200158269	6971.89
8200171021	6666.89

OE	VERNET
8200244023	6935.89
8200244402	6666.89
8200248531	6393.89
8200262237	6964.89
8200262241	6970.83
8200267349	6703.89
8200374994	6666.89
8200400553	6703.83
8200400554	6416.83
8200479402	6047.89
8933000140	4493.86
8983501426	6244.92
9617028380	CT1743.82

ROVER

13H7508	1290.82
602687	6510.82
610830	1290.88
GTS101	1419.82
GTS106	5504.88
GTS108	1419.82
GTS1106	5504.88
GTS275	5952.82
GTS279	5952.78
GTS280	1419.82
GTS282	5962.82
GTS283	6599.78
GTS285	5952.78
GTS286	5952.78
GTS287	5963.80
GTS298	5962.88
GTS299	1542.89
GTS300	6599.78
GTS301	5955.88
GTS302	1427.88
GTS303	5231.83
GTS319	6267.78
PEL000090	6952.88
PEL10016	5955.88
PEL10017	1427.88
PEL100570	6952.88
PEM100570	6952.88
PEM101020	6880.00

SAAB

24420728	6857.92
30577561	5981.89
4503017	6249.92
4503815	6249.92
4623815	6249.92
5342258	6857.92
5952148	6583.82
7505241	3334.92
8303935	3339.88
8358061	1290.88
8389512	1514.88
8817298	5981.89
8817538	6063.82
8822025	5981.89
9166687	3334.92



OE	VERNET
9194242	5981.89
9337379	1514.88

SCANIA

228842	1435.80
238156	1435.75
251899	1513.80
255502	1513.83
269374	1535.80
276012	1535.80

SEAT

022121113	6533.80
030121113	5151.84
032121110B	6274.87
037121113	6434.82
03C121110A	6965.00
03G121113	5962.88
044121113	6273.87
050121113C	6276.87
056121113D	1439.87
068121113H	3349.87
06F121111	6864.105
075121113D	5973.80
4296930	1522.87
4334988	245F.79
EA03222100	1473.88
FA03222107	3311.80
FC03222100	245F.79
GE03222100	245F.79
HB03222100	1522.87
SE020032221A	6070.87
SE021032221B	1439.87
SE700032221A	5074.80

SKODA

0044121113	6273.87
007072211A	6733.88
007072212A	6859.88
032121110B	6274.87
032121110F	5962.82
03G121113	5962.88
044121113	6273.87
047121111A	6859.88
047121111D	6733.88
047121111E	6733.88
047121111Q	6733.88
047121111S	6732.88
050121113C	6276.87
068121113H	3349.87
078121113F	5902.87
078121113G	6533.92
1130950	4608.80
113 095 090	4608.80
114095090	4608.88

SMART

0003179V010	6969.00
0004698V003000000	

OE	VERNET
6969.00	

SPK

(See / Voir TAMA)

SSANGYONG

6062030275	5699.85
6062030575	5699.85
8-94336-069-0	5971.82

SUBARU

16341-87281-000	6828.82
16341-87789-000	5077.88
17600-85821	3328.88
21200-AA010	5971.82
21200-AA040	5971.88
21200-AA050	5971.88
21200-AA060	5971.88
21200-AA071	6736.78
21200-AA072	6736.78
21200-KA010	3328.82
21200-KA040	3328.82
21200-KA050	3328.85
21200-KA150	3328.82
21200-KA151	3328.85
21200-KA152	3328.85
317530800	1378.83
317530811	1378.83
317531900	3328.82
317532400	3328.82
317534302	1378.88
417535400	3328.82
417535500	3328.82
417535600	3328.82
417535700	1248.80
417535800	3328.82
417537000	5971.82
417537100	5971.82
417537200	5971.82
417537300	5971.82
485785400	3328.88
497535500	3328.82
497535700	3328.82
90048-33088-000	6876.80

SUZUKI

17570-74000	1416.82
17570-74001	1416.82
17570-86CA0	5130.83
17570-A74001	6985.82
17600-60810	1416.82
17600-60811	1416.82
17600-60812	1416.82
17600-60813	5075.82
17600-60820	1416.88
17600-60821	1416.88
17600-60822	1416.88
17600-60823	1416.88
17600-77810	1416.82

17600-77811	1416.82
17600-77812	1416.82
17600-78E00	5980.88
17600-78E01	5980.88
17600-82810	3328.82
17600-82811	3328.82
17600-82820	3328.82
17600-82821	3328.82
17600-82830	3328.82
17600-82831	3328.88
17600-82840	3328.88
17600-82850	3328.88
17600-82860	3328.82
17600-83810	1416.82
17600-83811	1416.82
17600-83820	1416.82
17600-83821	1416.82
17600-83822	1416.82
17600-83823	1416.82
17600-83830	1416.88
17600-83831	1416.88
17600-83832	1416.88
17600-83833	1416.88
17600-83840	1416.92
17600-83841	1416.92
17600-83842	1416.92
17600-83843	1416.92
17600-83850	1416.88
17600-83851	1416.88
17600-85810	3328.82
17600-85811	3328.82
17600-85820	3328.88
17600-85821	3328.88
17600-85830	1416.82
17600-85831	5075.82
17600-85840	1416.92
17600-85841	1416.92
17608-38210	1477.82
17608-3821000	1477.82
17670-50G00	3328.82
17670-50G10	3328.88
17670-50G20	3328.92
17670-65020	3328.82
17670-65720	5077.88
17670-65D00	6737.82
17670-66D00	6737.82
17670-66D01	6737.82
17670-66G00	5130.83
17670-67020	3328.82
17670-67021	3328.82
17670-67022	3328.82
17670-73000	1416.82
17670-73020	1416.82
17670-73021	1416.82
17670-73030	1416.82
17670-73031	1416.82
17670-73031	1416.82
17670-76G00	3328.82
17670-76G10	3328.88
17670-77E00	6737.82
17670-77E10	6702.82

17670-77E11	6702.82
17670-79001	3328.82
17670-79100	1416.88
17670-79101	1416.88
17670-82000	3328.82
17670-82010	3328.88
17670-83000	1416.82
17670-83001	1416.82
17670-83010	1416.82
17670-83011	1416.82
17670-83020	1416.88
17670-83021	1416.88
17670-83700	1416.92
17670-83701	1416.92
17670-85000	3328.82
17670-85010	3328.88
17670-85811	3328.82
17670-85C00	6985.82
17670-M85030	3328.82
17690-67JG0	6628.89
17690-84A10	6666.89
17690-84E50-000	6835.88

TALBOT

0013173100	1418.83
0017907500	1335.87
0017907600	1529.83
002887800	2843.77
0055132200	1418.72
0055387300	1418.77
1337-27	6148.89
1337-34	1183.83
1337-53	1418.83
1337-64	4947.81
1337-97	1529.89
1338-20	4947.81
1338-37	5108.83
1338-44	6148.89
7932585117	1503.80
97517097	1529.89

TAMA

W44DA-82	3328.82
W44DA-88	3328.88
W44DE-82	3328.82
W44DE-88	3328.88
W44DX-82	3328.82
W44DX-88	3328.88
W445B-82	3328.82
W445C-82	3328.82
W445C-85	3328.85
W445C-88	3328.88
W52-82	1416.82
W52-88	1416.88
W52-92	1416.92
W52DA-82	6310.82
W52DA-88	6310.88
W52E-82	5075.82
W52E-88	5075.88
W52ER-82	5075.82



CORRESPONDANCES

CROSS REFERENCES/CROSS LIST

Correspondances

OE	VERNET	OE	VERNET	OE	VERNET	OE	VERNET
...TAMA		WV56TB-82	6295.82	90916-03059	6525.88	8620.10588	6245.82
W52ER-88	5075.88	WV56TC-82	6587.82	90916-03060	6484.82	8620.10592	6245.82
W52MA-82	5075.82	WV60TA-82	6520.82	90916-03061	6312.82	8620.10682	6007.88
W52MA-88	5075.88	WV64B-82	6297.82	90916-03062	5077.88	8620.10691	6007.88
W52SA-82	1416.82	WV64BC-78	6297.78	90916-03063	6484.88	8620.10782	6577.82
W52SA-88	1416.88	WV64TA-76	6583.76	90916-03065	6484.82	8620.1082	5812.82
W52SE-82	6737.82	WV64TA-82	6583.82	90916-03066	6525.82	8620.1088	6276.87
W52TA-82	6310.82	WV73-82	6525.82	90916-03067	6525.82	8620.1091	5812.92
W52TA-88	6310.88	WV73-88	6525.88	90916-03069	6484.82	8620.10982	1420.82
W54-76	1378.77	WW52-82	5076.82	90916-03070	6292.88	8620.10985	1335.87
W54-76.5	1378.77	WW52-88	5076.88	90916-03072	6312.88	8620.11082	4898.82
W54-82	1378.83	WW52EM-88	6292.88	90916-03075	6295.82	8620.11088	4898.87
W54-88	1378.88	WW54EM-88	5980.88	90916-03076	6525.82	8620.11188	5284.86
W54MA-82	1290.82			90916-03077	6525.82	8620.11277	1248.80
W54MA-88	1290.88	TOYOTA		90916-03078	6310.88	8620.11392	5111.80
W56FA-78	6736.78	16340-54010	6312.88	90916-03079	6585.82	8620.11488	5108.89
WV48B-76.5	6484.76	16340-54040	6312.82	90916-03080	6525.88	8620.11492	5108.89
WV48B-78	6484.76	90048-33055	6275.78	90916-03082	6484.76	8620.11571	1477.82
WV48B-82	6484.82	90916-03001	1416.75	90916-03083	6310.82	8620.1182	1477.82
WV48BA-76	5079.76	90916-03002	1416.82	90916-03084	6295.82	8620.1188	1477.87
WV48BA-82	5079.82	90916-03003	1416.75	90916-03088	6587.82	8620.1192	1477.92
WV48BA-88	5079.88	90916-03008	1416.82	90916-03089	6583.76	8620.1282	1410.83
WV52-76.5	1416.75	90916-03010	1416.82	90916-03090	6484.82	8620.1288	1410.87
WV52-82	5077.82	90916-03011	1416.82	90916-03092	6311.82	8620.1292	1410.92
WV52-88	5077.88	90916-03013	1416.75	90916-03093	6311.82	8620.1382	0963.80
WV52B-78	6599.78	90916-03016	5075.82	90916-03094	6583.82	8620.1388	0963.86
WV52BA-78	6599.78	90916-03019	6525.82	90916-03095	6484.82	8620.1482	1503.80
WV52BC-78	6267.78	90916-03020	1416.82	90916-03096	6484.82	8620.1582	4495.83
WV52BC-82	6267.82	90916-03021	1416.82	90916-03097	6520.82	8620.1588	4495.89
WV52DA-78	6275.78	90916-03022	5075.88	90916-03098	6520.76	8620.1591	4495.92
WV52DA-84	6275.84	90916-03023	5075.88	90916-03099	6312.88	8620.1682	1542.82
WV52M-82	6577.82	90916-03024	1416.75	90916-03100	6583.82	8620.1691	1542.89
WV52MA-82	6702.82	90916-03025	1416.75	90916-03101	6311.82	8620.1782	3357.82
WV52TA-82	6585.82	90916-03027	1416.82	90916-03102	6525.82	8620.1788	3357.88
WV52TA-88	6312.88	90916-03028	1416.82	90916-03103	6525.88	8620.1875	2620.75
WV54-76.5	1419.75	90916-03029	5075.88	90916-03106	6312.88	8620.1882	2620.82
WV54-82	1419.82	90916-03030	5075.88	90916-03109	6484.82	8620.1982	4856.82
WV54-88	1419.88	90916-03031	6525.82	90916-03112	6484.76	8620.1988	4856.88
WV54B-76	1419.75	90916-03032	6525.82	90916-03115	6484.82	8620.1991	4856.92
WV54B-76.5	1419.75	90916-03033	5075.82	90916-03117	6583.82	8620.2082	1508.83
WV54B-82	1419.82	90916-03034	1416.88	90916-03118	6520.82	8620.2091	1508.89
WV54B-88	1419.88	90916-03035	6310.82	90916-03119	6520.76	8620.2182	1418.83
WV54BC-82	5792.83	90916-03036	5075.88	90916-03120	6587.82	8620.2188	1418.89
WV54BN-76	6314.76	90916-03037	5075.82	90916-03122	6876.80	8620.2191	1418.89
WV54BN-76.5	6314.76	90916-03038	1477.87	90916-03123	6311.82	8620.2282	1335.80
WV54BN-82	6314.82	90916-03039	6525.82	90916-03125	6295.82	8620.2291	1335.92
WV54D-76	1419.75	90916-03040	6310.88	90916-03126	6311.88	8620.2382	1439.80
WV54D-76.5	1419.75	90916-03041	1416.88	90916-03127	6295.88	8620.2387	1439.87
WV54D-82	1419.82	90916-03042	6312.82	90916-03129	5434.82	8620.2391	1439.92
WV54D-88	1419.88	90916-03043	5077.88	90916-03201	6311.82	8620.2487	1522.87
WV54MA-82	6580.82	90916-03044	6525.82	SU001-00223	5130.83	8620.2492	1522.92
WV54MA-88	6580.88	90916-03045	6525.88			8620.2582	1535.80
WV56BN-76	6295.76	90916-03046	6484.82	TRIDON		8620.2588	1535.87
WV56BN-82	6295.82	90916-03048	6525.82	8620.10088	1476.87	8620.2591	1535.92
WV56BN-88	6295.88	90916-03049	6525.82	8620.10187	6274.87	8620.2677	1476.77
WV56MC-76.5	5434.76	90916-03054	6310.82	8620.10277	6267.78	8620.2679	1476.79
WV56MC-82	5434.82	90916-03055	6310.88	8620.10282	6275.84	8620.2682	1183.83
WV56-MC-88	5434.88	90916-03055-000	6310.88	8620.10288	6275.84	8620.2688	1183.87
WV56TA-82	6311.82	90916-03056	1416.82	8620.10482	CT1743.82	8620.2691	1183.92
WV56TA-88	6311.88	90916-03058	6525.82	8620.10490	CT1743.82	8620.2782	1248.83



OE	VERNET	OE	VERNET	OE	VERNET	OE	VERNET
8620.2788	1248.88	8620.7388	6292.88	271417.8	4561.87	3000.90	1378.88
8620.2882	5075.82	8620.7482	6543.80	271664	4561.92	3004.74	1290.73
8620.2888	5075.88	8620.7582	1533.83	271664.5	4561.92	3004.82	1290.82
8620.2982	5971.82	8620.7588	1533.88	272246	5968.87	3004.88	1290.88
8620.2988	5971.88	8620.7688	5284.86	272246.0	5968.87	3004.92	1290.92
8620.3082	1528.80	8620.7782	6525.82	272335	6867.90	3008.90	3339.88
8620.3088	1528.84	8620.7789	6525.88	272335.1	6867.90	3012.82	1416.82
8620.3188	4495.89	8620.7871	1290.73	273052	1515.81	3012.88	1416.88
8620.3191	4495.92	8620.7877	1290.77	273307	4856.92	3012.92	1416.92
8620.3282	1420.82	8620.7882	1290.82	273307.9	4856.92	3017.80	1410.80
8620.3288	1420.87	8620.7888	1290.88	273320	1183.75	3017.83	1410.83
8620.3391	1183.89	8620.8082	6311.82	273320.2	1183.83	3017.87	1410.87
8620.3482	4608.80	8620.8177	6267.78	273342.6	1514.81	3017.92	1410.92
8620.3488	4608.88	8620.8288	6580.88	273364.0	1183.92	3021.82	1410.83
8620.3583	3720.80	8620.8388	5980.88	273458.0	1514.88	3021.88	1410.87
8620.3680	3310.80	8620.8482	5434.82	273459.8	4856.88	3021.92	1410.92
8620.3685	3310.87	8620.8582	6297.82	273480.4	1183.87	3022.87	1522.87
8620.3787	3349.87	8620.8682	6484.76	273728.6	1535.87	3022.92	1522.92
8620.3880	3905.80	8620.8792	6286.92	273951	1515.76	3023.87	1473.88
8620.3982	1410.83	8620.8888	6247.87	273952	1515.81	3027.82	1477.82
8620.3988	1410.87	8620.8988	6285.87	273953	1514.76	3029.72	4495.71
8620.3992	1410.92	8620.9092	6222.92	274217	6865.90	3029.78	4495.75
8620.4080	5071.85	8620.9192	6171.92	30637217	6865.90	3029.83	4495.83
8620.4180	245F.79	8620.9292	6249.92	30637217.8	6865.90	3029.86	4495.86
8620.4185	245F.79	8620.9392	6237.92	30650022	6865.90	3029.89	4495.89
8620.4280	5686.80	8620.9482	6063.82	30650023	6866.90	3029.92	4495.92
8620.4380	5070.85	8620.9488	5981.89	30650469	6866.90	3032.80	4608.80
8620.4485	5071.85	8620.9491	5981.92	30650753.4	6881.90	3032.88	4608.88
8620.4587	6073.85	8620.9582	3328.82	30711526	6875.83	3033.78	0963.80
8620.4687	6070.87	8620.9588	3328.88	30711624	6837.82	3033.84	0963.86
8620.4780	5074.80	8620.9688	1335.87	30720083	6297.82	3038.87	3319.88
8620.4982	1519.82	8620.9691	1335.92	30735589	6756.84	3038.92	3319.88
8620.5078	6296.78	8620.9785	6497.85	30863985	4168.89	3044.80	1248.80
8620.5180	4947.81	8620.9871	1477.82	30874021	5434.82	3044.90	1248.88
8620.5287	3359.87	8620.9888	1477.92	30874021.6	5434.82	3046.87	1427.82
8620.5385	5699.85	8620.9892	5977.92	3183581	CT18201.76	3053.72	1413.72
8620.5482	1417.82			3183582	CT18201.86	3053.75	1414.75
8620.5488	1417.88			3267235.4	4495.89	3053.78	1414.79
8620.5491	1417.89			3273480.4	1183.87	3053.85	1414.84
8620.5582	1514.81			3287960.3	1417.89	3054.78	1378.77
8620.5588	1514.88			3343567	5108.83	3054.87	1378.88
8620.5682	1419.82			3344616.2	6318.92	3054.92	1378.92
8620.5688	1419.88			3344617.0	5108.89	3058.78	1378.77
8620.5788	5750.88			3345628	5108.89	3061.75	2620.75
8620.5882	5979.82			3345628.6	5108.89	3061.82	2620.82
8620.5892	5979.92			3447030.2	1417.89	3061.88	2620.88
8620.5992	6287.92			3449621.6	6318.92	3063.75	1417.75
8620.6182	5434.82			3470390	5083.83	3063.82	1417.82
8620.6288	5973.87			3474877	6045.89	3063.88	1417.88
8620.6382	5111.80			3474877.2	6045.89	3074.83	1473.83
8620.6388	5111.88			3485203	5757.89	3088.74	1419.75
8620.6482	6312.82			8149182	CT16957.82	3088.82	1419.82
8620.6488	6312.88			8149186	CT16953.86	3088.88	1419.88
8620.6582	5687.80			8653805	6756.84	3091.92	6273.92
8620.6688	5069.87					3099.87	5069.87
8620.6788	6598.87					3100.88	5977.88
8620.6888	4561.87					3105.87	5069.87
8620.6891	4561.92					3109.82	6598.82
8620.6988	4640.85					3109.87	6598.87
8620.7282	5077.82					3116.82	5700.82

VAUXHALL
(Voir / See General Motors)

VOLKSWAGEN
(Voir / See AUDI)

VOLVO

1544098	1515.81
1544390	1514.81
1544443	1514.66
1544683	CT16957.82
1661993	CT16958.76
1665694	CT16953.86
1676306	CT16957.82
20397955	CT18201.86
20397956	CT18201.76
20441483	CT18201.76
20441484	CT18201.86
20463750	CT18201.82
20560249	CT18201.82
20560252	CT18201.86
20560253	CT18201.76

WAHLER

3000.70	1378.70
3000.75	1378.74
3000.80	1378.80
3000.83	1378.83



CORRESPONDANCES

CROSS REFERENCES/CROSS LIST

OE	VERNET	OE	VERNET	OE	VERNET	OE	VERNET
...WAHLER		4006.82	1400.83	4123.87	5973.87	4256.87	1439.87
3118.82	5971.82	4006.87	1400.87	4126.82	3357.82	4256.92	1439.92
3118.88	5971.88	4008.74	5898.76	4126.88	3357.88	4264.84	5151.84
3119.82	5075.82	4008.79	5898.79	4136.79	1435.80	4264.87	5151.87
3119.88	5075.88	4008.83	5898.79	4137.80	6543.80	4269.78	6599.78
3123.68	6708.70	4015.75	1508.76	4144.92	5979.92	4270.88	5750.88
3123.75	6708.70	4015.83	1508.83	4145.92	6287.92	4272.90	4561.92
3136.82	1417.82	4015.90	1508.89	4147.80	4947.81	4274.87	5902.87
3136.88	1417.88	4022.74	1514.70	4150.79	1513.80	4275.87	6285.87
3141.87	6276.87	4022.77	1514.76	4150.83	1513.83	4276.87	6247.87
3143.87	6274.87	4022.82	1514.81	4151.76	3309.74	4278.80	6849.80
3151.87	6782.87	4022.88	1514.88	4151.79	3309.79	4281.87	6513.87
3159.82	1538.82	4026.77	1514.76	4154.82	3334.89	4297.97	6857.92
3163.88	6590.88	4026.83	1514.81	4155.87	6523.87	4337.105	6873.105
3164.88	6504.88	4026.89	1514.88	4158.80	5963.80	4371.80	1513.80
3174.89	5493.89	4029.71	1514.70	4160.83	6463.83	4446.83	5130.83
3199.88	5075.88	4029.76	1514.76	4161.83	1435.80	4450.83	4885.83
3301.80	6539.80	4029.81	1514.81	4164.92	6287.92	4455.80	6533.80
3302.80	5976.80	4030.70	1435.70	4165.79	1476.79	4457.82	6245.82
3303.80	6553.80	4030.80	1435.80	4166.79	6034.79	4480.82	6295.82
3333.87	3359.87	4038.76	1515.76	4168.92	6286.92	4516.70	6497.70
3334.80	1343.78	4038.81	1515.81	4174.79	5898.79	4516.85	6497.85
3334.87	1343.87	4059.75	1513.75	4174.82	6581.82	4519.95	6497.95
3336.83	3720.80	4064.75	1441.75	4174.82D	6581.82	4619.80	CT16957.82
3338.80	3359.87	4069.75	1513.75	4175.92	6249.92	4619.82	CT16957.82
3341.80	5687.80	4069.79	1513.80	4176.80	5699.80	4619.86	CT16953.86
3343.80	3905.82	4078.65	1476.60	4176.85	5699.85	4816.90	6865.90
3344.71	3310.71	4078.71	1476.70	4177.92	6222.92	4817.90	6866.90
3344.75	3310.75	4078.79	1476.79	4178.92	6171.92		
3344.80	3310.80	4078.87	1476.87	4180.82	6501.82		
3344.85	3310.87	4078.92	1476.92	4180.87	6501.87		
3345.79	3311.80	4083.71	1513.71	4180.87D	6501.87		
3346.80	245F.79	4083.79	1513.80	4180.92	6501.92		
3347.80	3905.82	4083.83	1513.83	4183.82	6237.82		
3349.78	245F.79	4088.80	1535.80	4183.92	6237.92		
3351.80	245F.79	4088.87	1535.87	4188.92	6516.92		
3351.85	245F.79	4088.92	1535.92	4198.92	6518.92		
3355.80	5686.80	4089.71	4856.71	4201.92	6855.92		
3356.80	3905.82	4089.82	4856.82	4206.90	6867.90		
3357.80	5070.85	4089.87	4856.88	4208.92	6519.92		
3358.85	5070.85	4089.92	4856.92	4231.71	1528.71		
3360.87	6073.85	4091.82	1519.82	4231.75	1528.75		
3361.87	6070.87	4095.83	1529.83	4231.80	1528.80		
3362.80	5074.80	4095.89	1529.89	4231.84	1528.84		
3363.85	5071.85	4096.82	1519.82	4232.71	1535.71		
3364.85	5071.85	4102.82	1542.82	4232.80	1513.80		
3365.80	6560.80	4103.82	3357.82	4235.71	5111.71		
3373.80	5686.80	4105.75	1513.75	4235.75	5111.75		
3378.80	5686.80	4105.79	1513.80	4235.80	5111.80		
3391.92	6251.92	4105.83	1513.83	4235.85	5111.88		
3412.87	6262.87	4114.87	5968.87	4236.88	5111.88		
3431.80	5687.80	4115.92	1335.92	4237.80	5973.80		
3435.87	6731.87	4116.87	5968.87	4238.92	6242.92		
3454.86	5284.86	4118.80	5699.80	4242.92	6856.92		
3463.89	6488.89	4118.85	5699.85	4247.80	6556.80		
3468.88	5980.88	4122.79	1183.75	4253.87	6273.87		
3469.91	5284.91	4122.87	1183.87	4255.87	6248.87		
3477.88	5077.88	4122.92	1183.92	4256.71	1439.71		
3478.82	6484.82	4123.70	5973.71	4256.80	1439.80		
4003.86	1508.83	4123.80	5973.80	4256.83	1439.80		

YUGO / ZASTAVA

0004154313	1473.88
0004298930	1522.78
0004423976	3905.82



CTM-1 / 2007

ANGLÍ

ANGLÍ INDUSTRIAS, S.A.

Sot d'en Rubió, s/n

Pol. Ind. La Borda

Apartado de Correos 7

08140 Caldes de Montbui

(Barcelona) España

Tel. 34 93 865 43 54

Fax 34 93 865 35 17

e-mail: iangli@angli-sa.com